

ICC PLAYING HANDBOOK

The official handbook for international cricket players,
officials and administrators **2013-2014**

www.icc-cricket.com



ICC PLAYING HANDBOOK 2013 - 2014

The official handbook for international cricket players,
officials and administrators

SECTION
01 Key ICC Contacts
02 ICC Member Countries
03 Standard Test Match Playing Conditions
04 Standard One-Day International Match Playing Conditions
05 Standard Twenty20 International Match Playing Conditions
06 Duckworth-Lewis
07 Women's Test Match Playing Conditions
08 Women's One-Day International Playing Conditions
09 Women's Twenty20 Playing Conditions
12 Pepsi ICC World Cricket League Standard Playing Conditions
13 ICC Code of Conduct for Players and Player Support Personnel
14 ICC Code of Conduct for Umpires
15 ICC Anti-Racism Code for Players and Player Support Personnel
16 ICC Anti-Doping Code
17 ICC Anti-Corruption Code for Participants
18 ICC Regulations for the Review of Bowlers Reported with Suspected Illegal Bowling Actions
19 Clothing and Equipment Rules and Regulations
20 Other ICC Regulations

KEY ICC CONTACTS

KEY ICC CONTACTS

ICC CONTACT DETAILS

ICC DUBAI	
Location	Sh Mohammed Bin Zayed Road Dubai Sports City, Street 69 Dubai, UAE
Address	Dubai Sports City P.O. Box 500070 Dubai, UAE
Main switchboard	+ (971) 4 382 8800
Fax	+ (971) 4 382 8600
Website	www.icc-cricket.com
General Enquiries	enquiry@icc-cricket.com
Media Enquiries	media@icc-cricket.com

CRICKET OPERATIONS	
General Manager – Cricket	Geoff Allardice Geoff.allardice@icc-cricket.com
Cricket Operations Manager	Clive Hitchcock Clive.hitchcock@icc-cricket.com
Umpires and Referees Manager	Vince van der Bijl Vince.vanderbijl@icc-cricket.com
Umpires and Referees Administration Manager	Adrian Griffith Adrian.griffith@icc-cricket.com

ANTI-CORRUPTION AND SECURITY UNIT

ACSU CONTACT DETAILS

ACSU Hotline	+ (971) 4 341 7225
ACSU Fax	+ 971 4 340 4856
Enquiries	contactACSU@icc-cricket.com
Media Enquiries	media@icc-cricket.com

All ACSU media enquiries should be directed to the ICC Media Department.

ICC REGIONAL SECURITY OFFICERS

Regional Security Manager	Arrie De Beer
Mobile:	+27 (0) 82 800 8124
Email:	arrie.debeer@icc-cricket.com

Regional Security Manager	Ronald J Hope
Mobile:	+44 788 050 7363
Email:	ron.hope@icc-cricket.com

Regional Security Manager	Peter O'Shea
Mobile:	+44 785 413 4811
Email:	peter.oshea@icc-cricket.com

Regional Security Manager	Hassan Raza
Mobile:	+92 (334) 947 3100
Email:	hassan.raza@icc-cricket.com

Regional Security Manager	John Rhodes
Mobile:	+61 438 535 009
Email:	john.rhodes@icc-cricket.com

Regional Security Manager / Senior Investigator	Niranjan Singh Virk
Mobile:	+91 981 052 0683
Email:	niranjan.virk@icc-cricket.com

Regional Security Manager	Dharamveer Singh Yadav
Mobile:	+91 971 139 5995
Email:	dharamveeryadav@icc-cricket.com

ICC MEMBER COUNTRIES

ICC FULL MEMBERS (10 Members)

Australia	New Zealand	West Indies
Bangladesh	Pakistan	Zimbabwe
England	South Africa	
India	Sri Lanka	

ICC ASSOCIATE MEMBERS (37 Members)

Afghanistan	Hong Kong	PNG
Argentina	Ireland	Scotland
Belgium	Israel	Singapore
Bermuda	Italy	Suriname
Botswana	Japan	Tanzania
Canada	Jersey	Thailand
Cayman Islands	Kenya	UAE
Denmark	Kuwait	Uganda
Fiji	Malaysia	USA
France	Namibia	Vanuatu
Germany	Nepal	Zambia
Gibraltar	The Netherlands	
Guernsey	Nigeria	

ICC AFFILIATE MEMBERS (59 Members)

Austria	Ghana	Philippines
Bahamas	Greece	Portugal
Bahrain	Hungary	Qatar
Belize	Indonesia	Romania
Bhutan	Iran	Russia
Brazil	Isle of Man	Rwanda
Brunei	Lesotho	Samoa
Bulgaria	Luxembourg	Saudi Arabia
Cameroon	Malawi	Seychelles
Chile	Maldives	Sierra Leone
China	Mali	Slovenia
Cook Islands	Malta	South Korea
Costa Rica	Mexico	Spain
Croatia	Morocco	St Helena
Cyprus	Mozambique	Swaziland
Czech Republic	Myanmar	Sweden
Estonia	Norway	Tonga
Falkland Islands	Oman	Turkey
Finland	Panama	Turks & Caicos Islands
Gambia	Peru	

Contact details for ICC Members can be found at the ICC website at www.icc-cricket.com/the-icc/icc_members/overview.php

STANDARD **TEST MATCH**
PLAYING CONDITIONS

STANDARD TEST MATCH PLAYING CONDITIONS

These playing conditions are applicable to all Test Matches from 1st October 2013 and supersede the previous version dated 30 April 2013. Included in this version are amendments to clauses 1.3, 2.2.2, 17.1, 17.2, 19.3, 23.1, 42.1, 42.1.1, Appendices 2, 4 and new clauses 24.2 and 42.1.2.

Except as varied hereunder, the Laws of Cricket (2000 Code - 5th Edition 2013) shall apply.

Note: All references to 'Governing Body' within the Laws of Cricket shall be replaced by 'ICC Match Referee'.

1 LAW 1 - THE PLAYERS

1.1 Law 1.1 - Number of Players

Law 1.1 shall be replaced by the following:

A match is played between two sides. Each side shall consist of 11 players, one of whom shall be captain.

1.2 Law 1.2 – Nomination of Players

Law 1.2 shall be replaced by the following:

- 1.2.1 Each captain shall nominate 11 players plus a maximum of 4 substitute fielders in writing to the ICC Match Referee before the toss. No player (member of the playing eleven) may be changed after the nomination without the consent of the opposing captain.
- 1.2.2 Only those nominated as substitute fielders shall be entitled to act as substitute fielders during the match, unless the ICC Match Referee, in exceptional circumstances, allows subsequent additions.
- 1.2.3 All those nominated including those nominated as substitute fielders, must be eligible to play for that particular team and by such nomination the nominees shall warrant that they are so eligible.
- 1.2.4 In addition, by their nomination, the nominees shall be deemed to have agreed to abide by all the applicable ICC Regulations pertaining to international cricket and in particular, the Clothing and Equipment Regulations, the Code of Conduct for Players and Player Support Personnel (hereafter referred to as the ICC Code of Conduct), the Anti-Racism Code for Players and Player Support Personnel, the Anti-Doping Code and the Anti-Corruption Code.

1.3 Law 1.3 - Captain

The following shall apply in addition to Law 1.3 (a):

The deputy must be one of the nominated members of the playing eleven.

Each Member Board must nominate its 'Test Team Captain' to the ICC when appointed.

If the 'Test Team Captain' is not participating in a series, the relevant Home Board must nominate a replacement 'Test Team Captain' for the series. The Home Board shall advise the series Match Referee.

If the 'Test Team Captain' plays in a match without being the nominated captain for that match, he will be deemed to be the captain should any penalties be applied for over rate breaches under the Code of Conduct.

2 LAW 2 - SUBSTITUTES AND RUNNERS, BATSMAN OR FIELDER LEAVING THE FIELD, BATSMAN RETIRING, BATSMAN COMMENCING INNINGS

2.1 Law 2.1 Substitutes and Runners

Law 2.1 (a) (ii), 2.7 and 2.8 shall not apply. A runner for a batsman when batting is not permitted.

Law 2.1 (b) shall be amended as follows:

The umpires shall have discretion to allow, for other wholly acceptable reasons, a substitute fielder to act for a nominated player, at the start of the match, or at any subsequent time.

2.2 Law 2.5 - Fielder absent or leaving the field

Law 2.5 shall be replaced by the following:

If a fielder fails to take the field with his side at the start of the match or at any later time, or leaves the field during a session of play, the umpire shall be informed of the reason for his absence, and he shall not thereafter come on to the field during a session of play without the consent of the umpire. (See Law 2.6 as modified). The umpire shall give such consent as soon as practicable.

If the player is absent from the field for longer than 8 minutes:

2.2.1 the player shall not be permitted to bowl in that innings after his return until he has been on the field for at least that length of playing time for which he was absent. Such absence or penalty time absent shall be carried over into a new day's play and in the event of a follow-on or forfeiture, this restriction will, if necessary, continue into the second innings.

2.2.2 the player shall not be permitted to bat unless or until, in the aggregate, he has returned to the field and/or his side's innings has been in progress for at least that length of playing time for which he has been absent or, if earlier, when his side has lost five wickets.

The restriction in clauses 2.2.1 and 2.2.2 above shall not apply if the player has suffered an external blow (as opposed to an internal injury such as a pulled muscle) whilst participating earlier in the match and consequently been forced to leave the field. Nor shall it apply if the player has been absent for very exceptional and wholly acceptable reasons (other than injury or illness).

In the event of a batsman or a fieldsman already being off the field at the commencement of an interruption in play through ground, weather or light conditions or for other exceptional circumstances, he shall be allowed to count any such stoppage time as playing time, provided that he personally informs the umpires when he is fit enough to take the field had play been in progress. Similarly, if at the commencement of an interruption in play through ground, weather or light conditions or for other exceptional circumstances, a player is on the field but still has some unexpired penalty time remaining from a previous absence, he shall automatically be allowed to count any such stoppage time as playing time.

2.2.3 Substitute fielders shall only be permitted in cases of injury, illness or other wholly acceptable reasons. 'Wholly acceptable reasons' should be limited to extreme circumstances and should not include what is commonly referred to as a 'comfort break'.

Note: Squad members of the fielding or batting team who are not playing in the match and who are not acting as substitute fielders shall be required to wear a team training bib whilst on the playing area (including the area between the boundary and the perimeter fencing).

3 LAW 3 - THE UMPIRES

3.1 Law 3.1 - Appointment and attendance

Law 3.1 shall be replaced by the following:

The following rules for the selection and appointment of Test Match umpires shall be followed as far as it is practicable to do so:

- 3.1.1 The umpires shall control the game as required by the Laws (as read with these playing conditions), with absolute impartiality and shall be present at the ground at least two hours before the scheduled start of the first day's play, and at least 1.5 hours before the scheduled start of each succeeding day's play.
- 3.1.2 ICC shall establish an 'Elite Panel' of umpires who shall be contracted to the ICC.
- 3.1.3 Each Full Member shall nominate from its panel of first class umpires two umpires to an 'International Panel' and one umpire to a 'TV Panel'. (A third umpire may be nominated to the 'International Panel' with the written consent of the ICC).
- 3.1.4 ICC will appoint two umpires to stand in each Test Match. Neither of such umpires shall be from the same country as the participating teams and shall be selected from the 'Elite Panel' or the 'International Panel'.
- 3.1.5 As long as possible before each Test Match, the ICC will advise the Home Board of the names of its appointees and the Home Board will advise the Manager of the visiting team of all umpires' names.
- 3.1.6 In Test Matches where the DRS is used (see clause 3.2 below), ICC will appoint a third umpire who shall act as the emergency umpire and officiate in regard to the DRS. Such third umpire shall not be from the same country as the participating teams and shall be appointed from the 'Elite Panel' or the 'International Panel'.
- 3.1.7 In all other Test Matches, the third umpire will be appointed by the Home Board and he shall act as the emergency umpire and officiate in regard to TV replays. Such appointment shall be made from the 'Elite Panel', the 'International Panel' or the 'TV Panel'.
- 3.1.8 The Home Board shall also appoint a fourth umpire for each Test Match from its panel of first class umpires. The fourth umpire shall act as the emergency third umpire. In 'DRS' Test Matches the fourth umpire shall be appointed from the "International Panel" or the "TV Panel".
- 3.1.9 ICC shall appoint the match referee for all matches (ICC Match Referee).
- 3.1.10 The ICC Match Referee shall not be from the same country as the participating teams.
- 3.1.11 Neither team will have a right of objection to an umpire's or match referee's appointment.

3.2 Third Umpire/ TV Replay System (DRS)

In matches where the DRS is used, the playing conditions set out in Appendix 2 shall apply.

In matches where the DRS is not used, the playing conditions set out in Appendix 4 shall apply.

3.3 Law 3.2 - Change of umpire

Law 3.2 shall be replaced by the following:

An umpire shall not be changed during the match, other than in exceptional circumstances, unless he is injured or ill.

3.4 Law 3.4 - To inform captains and scorers

The following shall apply in addition to Law 3.4 (i):

The Home Board may provide for the ringing of a bell, which shall be rung 5 minutes before the termination of an interval, when the umpires shall go to the wickets. The Home Board shall inform the ICC Match Referee and the Manager of the visiting team at the start of the tour that this practice is to be adopted.

3.5 Law 3.8 - Fitness for play and Law 3.9 - Suspension of play in dangerous or unreasonable conditions.

3.5.1 The safety of all persons within the ground is of paramount importance to the ICC. In the event that any threatening circumstance, whether actual or perceived, comes to the attention of any umpire (including for example weather, pitch invasions, act of God, etc. See also clauses 3.5.4 and 3.5.5), then the players and officials should immediately be asked to leave the field of play in a safe and orderly manner and to relocate to a secure and safe area (depending on each particular threat) pending the satisfactory passing or resolution of such threat or risk to the reasonable satisfaction of the umpires, ICC Match Referee, the head of the relevant ground authority, the head of ground security and/or the police as the circumstances may require.

Laws 3.8 & 3.9 shall be replaced by:

3.5.2 The umpires shall be the final judges of the fitness of the ground, weather and light for play. See clause 3.5.3 below and Law 7.2 (Fitness of the pitch for play).

3.5.3 Suspension of play for adverse conditions of ground, weather or light

- a) All references to ground include the pitch.
See Law 7.1 (Area of pitch).
- b) If at any time the umpires together agree that the conditions of ground, weather or light are so bad that there is obvious and foreseeable risk to the safety of any player or umpire, so that it would be unreasonable or dangerous for play to take place, then they shall immediately suspend play, or not allow play to commence or to restart. The decision as to whether conditions are so bad as to warrant such action is one for the umpires alone to make.

The fact that the grass and the ball are wet and slippery does not warrant the ground conditions being regarded as unreasonable or dangerous. If the umpires consider the ground is so wet or slippery as to deprive the bowler of a reasonable foothold, the fielders of the power of free movement, or the

batsmen of the ability to play their strokes or to run between the wickets, then these conditions shall be regarded as so bad that it would be unreasonable for play to take place.

The umpires shall disregard any shadow on the pitch from the stadium or from any permanent object on the ground.

- c) When there is a suspension of play it is the responsibility of the umpires to monitor the conditions. They shall make inspections as often as appropriate. Immediately the umpires together agree that conditions are suitable for play they shall call upon the players to resume the game.
 - d) If play is in progress up to the start of an agreed interval then it will resume after the interval unless the umpires together agree that the conditions of ground, weather or light are so bad that there is obvious and foreseeable risk to the safety of any player or umpire, so that it would be unreasonable or dangerous for play to take place.
- 3.5.4 Play may be suspended due to safety and security concerns by the umpires on the advice of the ICC Match Referee, the head of the relevant ground authority, the head of ground security or the police.
- 3.5.5 Where play is suspended under clause 3.5.4 above the decision to abandon or resume play shall be the responsibility of the ICC Match Referee who shall act only after consultation with the head of ground security and the police.

3.6 Light Meters

- 3.6.1 It is the responsibility of the ICC to supply light meters to the match officials to be used in accordance with these playing conditions.
- 3.6.2 All light meters shall be uniformly calibrated.
- 3.6.3 The umpires shall be entitled to use light meter readings as a guideline for determining whether the light is fit for play in accordance with the criteria set out in clause 3.5.3 (b) above.
- 3.6.4 Light meter readings may accordingly be used by the umpires:
- a) To determine whether there has been at any stage a deterioration or improvement in the light.
 - b) As benchmarks for the remainder of a stoppage, match and/or series/event.

3.7 Use of artificial lights

If in the opinion of the umpires, natural light is deteriorating to an unfit level, they shall authorize the ground authorities to use the available artificial lighting so that the match can continue in acceptable conditions.

The lights are only to be used to enable a full day's play to be completed as provided in clause 16 below.

In the event of power failure or lights malfunction, the provisions relating to the delay or interruption of play due to bad weather or light shall apply.

Notes: Home Boards may, prior to the commencement of the series, seek the approval of ICC to amend this playing condition to provide that artificial lights will not be used at specific venues.

For day/night Test matches (see clause 16.1.12) the latest times at which the floodlights are to be switched on each day shall be decided by the Home Board prior to the match and the ICC Match Referee shall be duly informed.

3.8 Advertising on grounds, perimeter boards and sightscreens

3.8.1 Advertising on grounds

The logos on outfielders are to be positioned as follows:

- a) Behind the stumps – a minimum of 25.15 yards (23 meters) from the stumps.
- b) Midwicket/cover area – no advertising to be positioned within 30 yards (27.50 meters) of the centre of the pitch being used for the match.

Note: Advertising closer to the stumps as set out above which is required to meet 3D requirements for broadcasters may be permitted, subject to prior ICC approval having been obtained.

3.8.2 Perimeter Boards

- a) Advertising on perimeter boards placed in front of the sightscreens is permitted save that the predominant colour of such advertising shall be of a contrasting colour to that of the ball.
- b) Advertising on perimeter boards behind the stumps at both ends shall not contain moving, flashing or flickering images and operators should ensure that the images are only changed or moved at a time that will not be distracting to the players or the umpires.
- c) In addition, the brightness of any electronic images shall be set at a level so that it is not a distraction to the players or umpires.

3.8.3 Sightscreens

- a) Sightscreens shall be provided at both ends of all grounds. For day-night Test matches, they will be black.
- b) Advertising shall be permitted on the sightscreen behind the striker, providing it is removed for the subsequent over from that end.
- c) Such advertising shall not contain flashing or flickering images and particular care should be taken by the operators that the advertising is not changed at a time which is distracting to the umpire.

4 LAW 4 - THE SCORERS

Law 4 shall apply.

5 LAW 5 - THE BALL

5.1 Law 5.2 - Approval and control of balls

Law 5.2 shall be replaced by the following:

The Home Board shall provide cricket balls of an approved standard for Test cricket and spare used balls for changing during a match, which shall also be of the same brand. Note: The Home Board shall be required to advise the Visiting Board of the brand of ball to be used in the match(es) at least 30 days prior to the start of the match(es). However, for day-night Test matches, the precise brand, type and colour of ball shall be subject to prior approval of the visiting Board.

The fielding captain or his nominee may select the ball with which he wishes to bowl from the supply provided by the Home Board. The fourth umpire shall take a box containing at least 6 new balls to the dressing room and supervise the selection of the ball.

The umpires shall retain possession of the match ball(s) throughout the duration of the match when play is not actually taking place. During play umpires shall periodically and irregularly inspect the condition of the ball and shall retain possession of it at the fall of a wicket, a drinks interval, or any other disruption in play.

5.2 Law 5.4 - New ball in a match of more than one day's duration

Law 5.4 shall be replaced by the following:

The captain of the fielding side shall have the choice of taking a new ball at any time after 80 overs have been bowled with the previous ball. The umpire shall inform the other umpire and indicate to the batsmen and the scorers whenever a new ball is taken into play.

5.3 Law 5.5 - Ball lost or becoming unfit for play

The following shall apply in addition to Law 5.5:

However, if the ball needs to be replaced after 110 overs for any of the reasons above, it shall be replaced by a new ball. If the ball is to be replaced, the umpire shall inform the batsmen and the fielding captain.

5.4 Law 5.6 - Specifications

Law 5.6 shall not apply.

6 LAW 6 - THE BAT

The following shall apply in addition to Law 6:

Only Type A bats shall be used in Test Matches.

7 LAW 7 - THE PITCH

7.1 Law 7.3 - Selection and preparation

The following will apply in addition to Law 7.3:

- 7.1.1 The ground staff shall ensure that during the period prior to the start of play and during intervals, the pitch area shall be roped off so as to prevent unauthorised access. (The pitch area shall include an area at least 2 metres beyond the rectangle made by the crease markings at both ends of the pitch).
- 7.1.2 The fourth umpire shall ensure that, prior to the start of play and during any intervals, only authorised staff, the ICC match officials, players, team coaches and authorised television personnel shall be allowed access to the pitch area. Such access shall be subject to the following limitations:
 - a) Only captains and team coaches may walk on the actual playing surface of the pitch area (outside of the crease markings).
 - b) Access to the pitch area by television personnel shall be restricted to one camera crew (including one or two television commentators) of the official licensed television broadcaster(s) (but not news crews).

- c) No spiked footwear shall be permitted.
 - d) No one shall be permitted to bounce a ball on the pitch, strike it with a bat or cause damage to the pitch in any other way.
 - e) Access shall not interfere with pitch preparation.
- 7.1.3 In the event of any dispute, the ICC Match Referee will rule and his ruling will be final.

7.2 Law 7.4 - Changing the pitch

Law 7.4 shall be replaced by the following:

- 7.2.1 In the event of a pitch being considered too dangerous for play to continue in the estimation of the on-field umpires, they shall stop play and immediately advise the ICC Match Referee.
- 7.2.2 The on-field umpires and ICC Match Referee shall consult with both captains.
- 7.2.3 If the captains agree to continue, play shall resume.
- 7.2.4 If the decision is not to resume play, the on-field umpires together with the ICC Match Referee shall consider whether the existing pitch can be repaired and the match resumed from the point it was stopped. In considering whether to authorise such repairs, the ICC Match Referee must consider whether this would place either side at an unfair advantage, given the play that had already taken place on the dangerous pitch.
- 7.2.5 If the decision is that the existing pitch cannot be repaired, then the match is to be abandoned as a draw.
- 7.2.6 If the abandonment occurs on the first scheduled day of the match, the ICC Match Referee shall consult with the Home Board with the objective of finding a way for a new match to commence on the same date and venue. Such a match may be played either on the repaired pitch or on another pitch, subject to the ICC Match Referee and the relevant ground authority both being satisfied that the new pitch will be of the required Test standard. The playing time lost between the scheduled start time of the original match and the actual start time of the new match will be covered by the provisions of clause 16.
- 7.2.7 If it is not possible to start a new match on the scheduled first day of the original match, the relevant officials from the participating Boards shall agree on whether the match can be replayed within the existing tour schedule.
- 7.2.8 Throughout the above decision making processes, the ICC Match Referee shall keep informed both captains and the head of the ground authority. The head of the ground authority shall ensure that suitable and prompt public announcements are made.

7.3 Law 7.5 - Non-turf pitches

Law 7.5 shall not apply.

All matches shall be played on natural turf pitches. The use of PVA and other adhesives in the preparation of pitches is not permitted.

8 LAW 8 - THE WICKETS**8.1 Law 8.2 - Size of stumps**

The following shall apply in addition to Law 8.2:

For televised matches the Home Board may provide a slightly larger cylindrical stump to accommodate the stump camera. When the larger stump is used, all three stumps must be exactly the same size.

9 LAW 9 - THE BOWLING, POPPING AND RETURN CREASES**9.1 Law 9.3 - The popping crease**

Law 9.3 shall apply, except that the reference to 'a minimum of 6 ft' shall be replaced by 'a minimum of 15 yards (13.71 metres)'.

10 LAW 10 - PREPARATION AND MAINTENANCE OF THE PLAYING AREA**10.1 Law 10.1 - Rolling**

The following shall apply in addition to Law 10.1:

- 10.1.1 Prior to tossing for choice of innings the artificial drying of the pitch and outfield shall be at the discretion of the ground curator. Thereafter and throughout the match the drying of the outfield may be undertaken at any time by the ground curator, but the drying of the affected area of the pitch shall be carried out only on the instructions and under the supervision of the umpires. The umpires shall be empowered to have the pitch dried without reference to the captains at any time they are of the opinion that it is unfit for play.
- 10.1.2 The umpires may instruct the ground curator to use any available equipment, including any roller for the purpose of drying the pitch and making it fit for play.
- 10.1.3 An absorbent roller may be used to remove water from the covers including the cover on the match pitch.

10.2 Law 10.6 - Maintenance of footholes

The following shall apply in addition to Law 10.6:

The umpires shall see that wherever possible and whenever it is considered necessary, action is taken during all intervals in play to do whatever is practicable to improve the bowler's foot holes. As soon as possible after the conclusion of each day's play, bowler's foot holes will be repaired.

10.3 Watering the outfield

The watering of the outfield will be permitted during the match subject to the following:

- 10.3.1 Such watering shall only be possible if the "watering plan" is requested by the ground curator and approved by the umpires before the match has started. Once the match has started, any such request will not be considered.
- 10.3.2 The consent of the captains is not required but the umpires shall advise both captains and the ICC Match Referee before the start of the match on what has been agreed.
- 10.3.3 The watering shall occur as soon as possible after the conclusion of the day's play.

- 10.3.4 The watering shall only be carried out to the extent that it is necessary to retain the good condition of the outfield.
- 10.3.5 The square and bowlers' run ups will be adequately covered prior to any watering taking place.
- 10.3.6 All ongoing matters of interpretation and implementation of watering requirements and regulations shall be resolved between the umpires and ground curator, but with the umpires retaining ultimate discretion over whether to approve any watering.

10.4 Protection and preparation of adjacent pitches during matches

The protection (by way of an appropriate cover) and preparation of pitches which are adjacent to the match pitch will be permitted during the match subject to the following:

- 10.4.1 Such measures will only be possible if requested by the ground curator and approved by the umpires before the start of the match.
- 10.4.2 Approval should only be granted where such measures are unavoidable and will not compromise the safety of the players or their ability to execute their actions with complete freedom.
- 10.4.3 The preparation work shall be carried out under the supervision of the fourth umpire.
- 10.4.4 Any necessary watering shall be carried out only to the extent necessary for such preparations and shall not be permitted in circumstances which may in any way affect the match pitch.
- 10.4.5 The consent of the captains is not required but the umpires shall advise both captains and the ICC Match Referee before the start of the match on what has been agreed.

11 LAW 11 - COVERING THE PITCH

11.1 Law 11.1 - Before the match

The following shall apply in addition to Law 11.1:

The pitch shall be entirely protected against rain up to the commencement of play.

11.2 Law 11.2 - During the match

Law 11.2 shall be replaced by the following:

The pitch shall be entirely protected against rain up to the commencement of play and for the duration of the period of the match. It shall be wholly covered at the termination of each day's play or providing the weather is fine, within a period of two hours thereafter.

Note: the covers must totally protect the pitch and also the pitch surroundings, a minimum 5 metres either side of the pitch and any worn or soft areas in the outfield.

11.3 Law 11.3 - Covering bowlers' run ups

Law 11.3 shall be replaced by the following:

The bowlers' run-ups shall be covered in inclement weather, in order to keep them dry, to a distance of at least 10 x 10 metres.

11.4 Law 11.4 - Removal of covers

Law 11.4 shall be replaced by the following:

All covers (including “hessian” or “scrim” covers used to protect the pitch against the sun) shall be removed not later than 2½ hours before the scheduled start of play provided it is not raining at the time, but the pitch will be covered again if rain falls prior to the commencement of play.

Attention is drawn to clauses 3.5 and 10.4 above.

12 LAW 12 - INNINGS

Law 12 shall apply subject to the following:

12.1 Law 12.1 (a) shall be replaced by the following:

A match shall be two innings per side subject to the provisions of Law 13.1.

12.2 Law 12.1 (b) and Law 12.3 (e) shall not apply.**12.3** Matches shall be of five days scheduled duration. The two participating countries may:

12.3.1 Provide for a rest day during the match, and/or a reserve day after the scheduled days of play.

12.3.2 Play on any scheduled rest day, conditions and circumstances permitting, should a full day's play be lost on any day prior to the rest day.

12.3.3 Play on any scheduled reserve day, conditions and circumstances permitting, should a full day's play be lost on any day. Play shall not take place on more than 5 days.

12.3.4 Make up time lost in excess of five minutes in each day's play due to circumstances outside the game other than Acts of God.

12.4 Law 12.4 - The toss

Law 12.4 shall be replaced by the following:

The captains shall toss for the choice of innings, on the field of play and in the presence of the ICC Match Referee, who shall supervise the toss. The toss shall take place not earlier than 30 minutes, nor later than 15 minutes before the scheduled or any rescheduled time for the match to start. Note, however, the provisions of Law 1.3 (Captain).

Note: Law 12.5 requiring the captain of the side winning the toss to notify the opposing captain as soon as the toss is completed of his decision to bat or to field shall apply.

13 LAW 13 - THE FOLLOW-ON**13.1 Law 13.3 - First day's play lost**

If the provisions of clause 16.1.3 (b) are applied, the additional time is regarded as part of that day's play, i.e. it is the number of days remaining, and not the total number of hours available.

14 LAW 14 - DECLARATION AND FORFEITURE

Law 14 shall apply.

15 LAW 15 - INTERVALS

15.1 Law 15.3 - Duration of intervals

15.1.1 Luncheon Interval: The interval shall be of 40 minutes duration.

15.1.2 Tea Interval: The interval shall be of 20 minutes duration.

Notes: Home Boards may, prior to the start of the series and with the consent of the visiting Board, seek the approval of ICC to amend this playing condition to provide for lunch and tea intervals of 30 minutes each.

For day/night Test matches, the Home Boards with the consent of the visiting Board, may seek the approval of ICC to amend this playing condition provided the combined duration of the two intervals shall be equal to 60 minutes (see also clause 16.1.12).

15.2 Law 15.8 - Tea interval - 9 wickets down

Law 15.8 shall apply.

In addition, the provisions of Law 15.8 as applicable to the tea interval shall also apply to the lunch interval.

15.3 Law 15.9 - Intervals for Drinks

The provisions of Law 15.9 shall be strictly observed except that under conditions of extreme heat the umpires may permit extra intervals for drinks.

An individual player may be given a drink either on the boundary edge or at the fall of a wicket, on the field, provided that no playing time is wasted. No other drinks shall be taken onto the field without the permission of the umpires. Any player taking drinks onto the field shall be dressed in proper cricket attire. (subject to the wearing of bibs – refer to the note in clause 2.2.3).

16 LAW 16 - START OF PLAY; CESSATION OF PLAY

Law 16 shall apply subject to the following:

16.1 Start and Cessation Times

Subject to the provisions of clause 16.1.12 below, the Home Board shall determine the hours of play, subject to there being 6 hours scheduled play per day, and subject to:

16.1.1 Minimum Overs in the Day

Subject to clause 16.1.2 below:

- a) On days other than the last day, play shall continue on each day until the completion of a minimum target of 90 overs (or a minimum of 15 overs per hour) or the completion of the scheduled or rescheduled cessation time, whichever is the later but provided that play shall not continue for more than 30 minutes beyond the scheduled or rescheduled cessation time (permitted overtime). For the sake of clarity, if any of the minimum target number of overs have not been bowled at the completion of the permitted overtime, play shall cease upon completion of the over in progress. The overs not bowled shall not be made up on any subsequent day.

- b) On the last day, a minimum of 75 overs (or a minimum of 15 overs per hour) shall be bowled during the playing time other than the last hour of the match where clause 16.1.6 below shall apply. If any of the minimum of 75 overs, or as recalculated, have not been bowled when one hour of the scheduled playing time remains, the last hour of the match for the purposes of clause 16.1.6 shall be the hour immediately following the completion of these overs.

16.1.2 Reduction in minimum overs

Except in the last hour of the match, for which clause 16.1.6 makes provision, if play is suspended due to adverse weather or light or any other reason (other than normal intervals) for more than 1 hour on any day, the minimum number of overs shall be reduced by 1 over for each full 4 minutes of the aggregate playing time lost. For the avoidance of doubt, the aggregate of 1 hour shall be inclusive of any time that may have been brought forward from previous days due to playing time lost on such previous days under clause 16.1.3 (b) below.

16.1.3 Making Up Lost Time

a) On The Day

Subject to weather and light, except in the last hour of the match, in the event of play being suspended for any reason other than normal intervals, the playing time on that day shall be extended by the amount of time lost up to a maximum of 1 hour. For the avoidance of doubt, the maximum of 1 hour shall be inclusive of any time that may have been added to the scheduled playing time due to playing time having been lost on previous days under clause 16.1.3 (b) below.

b) On Subsequent Days

If any time is lost and cannot be made up under clause 16.1.3 (a) above, additional time of up to a maximum of 30 minutes per day shall be added to the scheduled playing hours for the next day, and subsequent day(s) as required (to make up as much lost time as possible). Where appropriate this additional time shall be added prior to the scheduled start of the first session. In circumstances where it is not possible to add this additional time prior to the scheduled start of the first session, the additional time may be added to the second and/or the third sessions (see also clause 16.1.4). When such additional time is added, the minimum overs for that day shall be increased by one over for each four minutes of additional time or part thereof.

c) On the Last Day only (Refer Appendix 6)

Clause 16.1.3 (a) applies. However, for the purposes of this clause, the definition of playing time shall exclude the last hour. No time is made up in respect of any interruptions that commence after the start of the last hour.

Should play be interrupted prior to the last hour being signalled, the playing time lost will be made up (subject to the maximum of 1 hour described in (a) above) with the previously scheduled time for the last hour being updated to reflect the time made up during this interruption.

In order to determine the minimum overs to be bowled prior to the last hour and the rescheduled starting time for the last hour, it is necessary to complete the template in Appendix 6.

16.1.4 Change of Intervals

- a) If play has been suspended for any reason other than normal intervals for 30 minutes or more prior to the commencement of the scheduled or rescheduled tea interval on that day, the tea interval shall be delayed for 1/2 hour.
- b) Notwithstanding the provisions of clause a) above, the timings of intervals can be altered under Law 15.5 at any time on any day if playing time has been lost irrespective of whether the time has been lost on that day or on any previous days.

16.1.5 Change of Innings

Where there is a change of innings during a day's play (except where the change of innings occurs at lunch or tea or when play is suspended for any reason) 2 overs will be deducted from the minimum number of overs to be bowled.

The over in progress at the end of an innings is regarded as a completed over for the purposes of determining the minimum number of remaining overs to be bowled in the day.

16.1.6 Last Hour

Law 16.6, 16.7 and 16.8 will apply except that a minimum of 15 overs shall be bowled in the last hour and all calculations with regard to suspensions of play or the start of a new innings shall be based on 1 over for each full 4 minutes (refer clause 16.1.9 below).

On the final day, if both captains (the batsmen at the wicket may act for their captain) accept that there is no prospect of either side achieving a victory, they may agree to finish the match after (a) the time for the commencement of the last hour has been reached OR (b) there are a minimum of 15 overs to be bowled, whichever is the later.

16.1.7 Notwithstanding any other provision, there shall be no further play on any day, other than the last day, if a wicket falls or a batsman retires or if the players have occasion to leave the field during the last minimum over within 2 minutes of the scheduled cessation time or thereafter. This shall also apply to the additional time permitted in order to complete the minimum over requirement for the day. If an over is interrupted in these circumstances stumps shall be drawn for the day and the over shall be completed on the resumption of play.

16.1.8 An over completed on resumption of a new day's play shall be disregarded in calculating minimum overs for that day.

16.1.9 Stumps Drawn

Except on the final day:

- a) In the event of play being suspended for any reason at or after the most recently scheduled or rescheduled cessation time, stumps shall be drawn upon play being suspended.
- b) In the event of the players already being off the field for a suspension of play at the most recently rescheduled cessation time, then stumps will be drawn at that time.

16.1.10 The scoreboard shall show:

- a) the total number of overs bowled with the ball currently in use: and
- b) the minimum number of overs remaining to be bowled in a day.

- 16.1.11 Penalties shall apply for slow over rates (refer ICC Code of Conduct and see clause 16.3 below).
- 16.1.12 Home Boards may, prior to the commencement of a Test, and with the agreement of the visiting Board, seek the approval of ICC to play the match as a day/night Test. In such a case the hours of play shall be determined by agreement between the participating Boards subject to there being 6 hours scheduled play per day.

16.2 Extra Time

- 16.2.1 The umpires may decide to play 30 minutes (a minimum of eight overs) extra time at the end of any day (other than the last day) if requested by either captain if, in the umpires opinion, it would bring about a definite result on that day [this is in addition to the additional time provided for in clause 16.1.3 above]. If the umpires do not believe a result can be achieved no extra time shall be allowed.

If it is decided to play such extra time on one or more of these days, the whole period shall be played out even though the possibility of finishing the match may have disappeared before the full period has expired.

Only the actual amount of playing time up to the maximum 30 minutes extra time by which play is extended on any day shall be deducted from the total number of hours of play remaining, and the match shall end earlier on the final day by the amount of time by which play was previously extended under this clause.

- 16.2.2 The umpires may decide to play 15 minutes (a minimum of four overs) extra time at the scheduled lunch or tea interval of any day if requested by either captain if, in the umpires' opinion, it would bring about a definite result in that session. If the umpires do not believe a result can be achieved no extra time shall be allowed.

If it is decided to play such extra time, the whole period shall be played out even though the possibility of finishing the match may have disappeared before the full period has expired.

Only the actual amount of playing time up to the maximum 15 minutes extra time by which play is extended on any day shall be deducted from the total number of hours of play remaining, and the following session of play shall be reduced by the amount of time by which play was previously extended under this clause.

For the avoidance of doubt, Law 15.8, as amended by Clause 15.2, shall still apply subsequent to the application of this clause, i.e. when 9 wickets are down following the extra 15 minutes. However, this clause shall not apply when Law 15.8, as amended by Clause 15.2, has already been applied, i.e. the 15 minutes shall not be added at the end of 30 minutes extra time.

16.3 Minimum Over Rates

The minimum over rate to be achieved in Test Matches will be 15 overs per hour.

The actual over rate will be calculated at the end of the match by the umpires and will be the average rate which is achieved by the fielding team across both of the batting team's innings.

In calculating the actual over rate for the match, allowances will be given as follows:

- 16.3.1 The time lost as a result of treatment given to a player by an authorised medical personnel on the field of play;
- 16.3.2 The time lost as a result of a player being required to leave the field as a result of a serious injury;
- 16.3.3 The time taken for all third umpire referrals and consultations and any umpire or player reviews;
- 16.3.4 The time lost as a result of time wasting by the batting side; and
- 16.3.5 The time lost due to all other circumstances that are beyond the control of the fielding side.
- 16.3.6 2 minutes per wicket taken, provided that such wicket results in the subsequent batsmen immediately commencing his innings. For the avoidance of any doubt, no time allowance will be given for the final wicket of an innings or where a wicket falls immediately prior to any interval;
- 16.3.7 4 minutes per drinks break taken (one per session).

In the event of any time allowances being granted to the fielding team under 16.3.4 above (time wasting by batting team), then such time shall be deducted from the allowances granted to such batting team in the determination of its over rate.

If a side is bowled out in $3\frac{1}{2}$ hours or less (taking into account all of the time allowances set out above) in any particular innings, no account will be taken of the actual over rate in that innings when calculating the actual over rate at the end of the match.

17 LAW 17 - PRACTICE ON THE FIELD

Law 17 shall apply subject to the following:

17.1 Law 17.1 - Practice on the pitch or the rest of the square

Law 17.1 shall apply subject to the following:

- a) The use of the square for practice on any day of any match will be restricted to any netted practice area or bowling strips specifically prepared on the edge of the square for that purpose.
- b) Bowling practice on the bowling strips referred to in (a) above shall also be permitted during the interval (and change of innings if not the interval) unless the umpires consider that, in the prevailing conditions of ground and weather, it will be detrimental to the surface of the square.

17.2 Law 17.3 - Practice on the outfield between the call of play and the call of time

Law 17.3 shall apply save that Law 17.3 (c) shall be replaced with the following:

- c) There shall be no bowling or batting practice on the outfield. Bowling a ball, using a short run up to a player in the outfield is not to be regarded as bowling practice but shall be subject to the law.

18 LAW 18 - SCORING RUNS

Law 18 shall apply.

19 LAW 19 - BOUNDARIES

Law 19 shall apply subject to the following:

19.1 Law 19.1 - The boundary of the field of play

The following shall apply in addition to Law 19.1:

The playing area shall be a minimum of 150 yards (137.16 metres) from boundary to boundary square of the pitch, with the shorter of the two square boundaries being a minimum 65 yards (59.43 metres). The straight boundary at both ends of the pitch shall be a minimum of 70 yards (64.00 metres). Distances shall be measured from the centre of the pitch to be used.

In all cases the aim shall be to provide the largest playing area, subject to no boundary exceeding 90 yards (82.29 meters) from the centre of the pitch to be used.

Any ground which has been approved to host international cricket prior to 1st October 2007 or which is currently under construction as of this date which is unable to conform to these new minimum dimensions shall be exempt. In such cases the regulations in force immediately prior to the adoption of these regulations shall apply.

19.2 Law 19.2 - Defining the boundary - boundary marking

The following shall apply in addition to Law 19.2:

All boundaries must be designated by a rope or similar object of a minimum standard as authorised by the ICC from time to time. Where appropriate the rope should be a required minimum distance (3 yards (2.74 metres) minimum) inside the perimeter fencing or advertising signs. For grounds with a large playing area, the maximum length of boundary should be used before applying the minimum 3 yards (2.74 metres) between the boundary and the fence.

19.3 Law 19.3 - Scoring a boundary

The following shall be added to Law 19.3:

If an unauthorized person enters the playing arena and handles the ball, the umpire at the bowler's end shall be the sole judge of whether the boundary allowance should be scored or the ball be treated as still in play or called dead ball if a batsman is liable to be out as a result of the unauthorized person handling the ball. See also Law 19.1 (c).

20 LAW 20 - LOST BALL

Law 20 shall apply.

21 LAW 21 - THE RESULT

Law 21 shall apply subject to the following:

21.1 Law 21.2 - A win-one innings match

Law 21.2 shall not apply

21.2 Law 21.3 – Umpire (ICC Match Referee) awarding a match

Law 21.3 shall be replaced by the following:

- a) A match shall be lost by a side which either
 - i) concedes defeat or
 - ii) in the opinion of the ICC Match Referee refuses to play and the ICC Match Referee shall award the match to the other side.

- b) If an umpire considers that an action by any player or players might constitute a refusal by either side to play then the umpires together shall inform the ICC Match Referee of this fact. The ICC Match Referee shall together with the umpires ascertain the cause of the action. If the ICC Match Referee, after due consultation with the umpires, then decides that this action does constitute a refusal to play by one side, he shall so inform the captain of that side. If the captain persists in the action the ICC Match Referee shall award the match in accordance with (a)(ii) above.*
- c) If action as in (b) above takes place after play has started and does not constitute a refusal to play:
 - i) playing time lost shall be counted from the start of the action until play recommences, subject to Law 15.5 (Changing agreed times for intervals).
 - ii) the time for close of play on that day shall be extended by this length of time, subject to Law 3.9 (Suspension of play in dangerous and unreasonable conditions) and the provisions of clause 16.
 - iii) if applicable, no overs shall be deducted during the last hour of the match solely on account of this time.

*N/B In addition to the consequences of any refusal to play prescribed under this clause, any such refusal, whether temporary or final, may result in disciplinary action being taken against the captain and team responsible under the ICC Code of Conduct.

21.3 Law 21.4 – Matches in which there is an agreement under Law 12.1(b)

Law 21.4 shall not apply.

21.4 Law 21.8 - Correctness of result

Any query on the result of the match as defined in Laws 21.1, 21.3, 21.5, 21.8 and 21.10 shall be resolved as soon as possible and a final decision made by the umpires at close of play.

22 LAW 22 - THE OVER

Law 22 shall apply subject to the addition of the following to Law 22.5:

22.1 Law 22.5 - Umpire miscounting

Whenever possible the third umpire shall liaise with the scorers and if possible inform the on-field umpires if the over has been miscounted.

23 LAW 23 - DEAD BALL

law 23 shall apply subject to the addition of the following to law 23.4.

23.1 Law 23.4 – Umpire calling and signalling 'Dead Ball'

In a match where cameras are being used on or over the field of play (e.g. Spydercam), should a ball that has been hit by the batsman make contact, while still in play, with the camera, its apparatus or its cable, either umpire shall call and signal 'dead ball'. The ball shall not count as one of the over and no runs shall be scored. If the delivery was called a no ball it shall count and the no ball penalty applied. No other runs (including penalty runs) apart from the no ball penalty shall be scored.

Should a ball thrown by a fielder make contact with a camera on or over the field of play, its apparatus or its cable, either umpire shall call and signal dead ball. Unless this was already a no-ball or wide, the ball shall count as one of the over. All runs scored to that point shall count, plus the run in progress if the batsmen have already crossed.

24 LAW 24 - NO BALL

Law 24 shall apply subject to the following:

24.1 Law 24.1 - Mode of delivery

Law 24.1 (b) shall be replaced by the following:

The bowler may not deliver the ball underarm. If a bowler bowls a ball underarm the umpire shall call and signal no ball, and the ball is to be re-bowled overarm.

24.2 Fair Delivery - the feet

Law 24.5 shall apply, subject to the final paragraph being replaced by the following:

If the bowler's end umpire is satisfied that any of these three conditions have not been met, he shall call and signal No ball.

25 LAW 25 - WIDE BALL**25.1 Law 25.1 - Judging a Wide**

Law 25 shall apply with the following addition to Law 25.1 (Judging a wide):

For bowlers attempting to utilise the rough outside a batsman's leg stump, not necessarily as a negative tactic, the strict limited over wide interpretation shall be applied.

For bowlers whom umpires consider to be bowling down the leg side as a negative tactic, the strict limited over wide interpretation shall be applied.

26 LAW 26 - BYE AND LEG BYE

Law 26 shall apply.

27 LAW 27 - APPEALS

Law 27 shall apply.

28 LAW 28 - THE WICKET IS DOWN

Law 28 shall apply.

29 LAW 29 - BATSMAN OUT OF HIS GROUND

Law 29 shall apply.

30 LAW 30 - BOWLED

Law 30 shall apply.

31 LAW 31 - TIMED OUT

Law 31 shall apply.

Refer also to clause 42.9 (Law 42.10).

32 LAW 32 - CAUGHT

Law 32 shall apply.

33 LAW 33 - HANDLED THE BALL

Law 33 shall apply.

34 LAW 34 - HIT THE BALL TWICE

Law 34 shall apply.

35 LAW 35 - HIT WICKET

Law 35 shall apply.

36 LAW 36 - LEG BEFORE WICKET

Law 36 shall apply.

37 LAW 37 - OBSTRUCTING THE FIELD

Law 37 shall apply. For the avoidance of doubt, if an umpire feels that a batsman, in running between the wickets, has significantly changed his direction without probable cause and thereby obstructed a fielder's attempt to effect a run out, the batsman should, on appeal, be given out, obstructing the field. It shall not be relevant whether a run out would have occurred or not.

If the change of direction involves the batsman crossing the pitch, Law 42.14 shall also apply.

See also paragraph 2.4 of Appendix 2 and paragraph 5 of Appendix 4.

38 LAW 38 - RUN OUT

Law 38 shall apply.

39 LAW 39 - STUMPED

Law 39 shall apply.

40 LAW 40 - THE WICKET-KEEPER

Law 40 shall apply.

41 LAW 41 - THE FIELDER

Law 41 shall apply subject to the following:

41.1 Law 41.1 - Protective equipment

In addition to Law 41.1:

The exchanging of protective equipment between members of the fielding side on the field shall be permitted provided that the umpires do not consider that it constitutes a waste of playing time.

42 LAW 42 - FAIR AND UNFAIR PLAY

Law 42 shall apply subject to the following:

42.1 Law 42.3 - The match ball - changing its condition

Law 42.3 shall apply, subject to the following:

Law 42.3 (d) and (e) shall be replaced with the following:

If the umpires together agree that the deterioration of the ball is inconsistent with the use it has received, they shall consider that there has been a contravention of this Law. They shall then decide together whether they can identify the player(s) responsible for such conduct.

42.1.1 If it is possible to identify the player(s) responsible:

- a) Change the ball forthwith. The batsman at the wicket shall choose the replacement ball from a selection of six other balls of various degrees of usage (including a new ball) and of the same brand as the ball in use prior to the contravention.

Additionally the bowler's end umpire shall:

- b) Award 5 penalty runs to the batting side.
- c) Inform the captain of the fielding side of the reason for the action taken.
- d) Inform the captain of the batting side as soon as practicable of what has occurred.
- e) Together with the other umpire report the incident to the ICC Match Referee who shall take action as is appropriate against the player(s) responsible for the conduct under the ICC Code of Conduct.

42.1.2 If it is not possible to identify the player(s) responsible:

- a) Change the ball forthwith. The umpires shall choose the replacement ball for one of similar wear and of the same brand as the ball in use prior to the contravention.
- b) The bowler's end umpire shall issue the captain with a first and final warning, and
- c) Advise him that should there be any further incident by that team during the remainder of the match, steps 42.1.1 a) to e) above will be adopted, with the captain deemed under e) to be the player responsible.

42.2 Law 42.4 - Deliberate attempt to distract striker

Law 42.4 shall apply subject to the following:

In addition, the umpires shall report the incident to the ICC Match Referee under the ICC Code of Conduct.

42.3 Law 42.5 - Deliberate distraction or obstruction of batsman

Law 42.5 shall apply subject to the following:

In addition, the umpires shall report the incident to the ICC Match Referee under the ICC Code of Conduct.

42.4 Law 42.6 - Dangerous and Unfair Bowling**42.4.1 Law 42.6 (a) - The Bowling of Fast Short Pitched Balls**

Law 42.6 (a) shall be replaced by the following:

- a) A bowler shall be limited to two fast short-pitched deliveries per over.
- b) A fast short-pitched delivery is defined as a ball, which passes or would have passed above the shoulder height of the striker standing upright at the popping crease.
- c) The umpire at the bowler's end shall advise the bowler and the batsman on strike when each fast short pitched delivery has been bowled.
- d) In addition, for the purpose of this regulation and subject to clause 42.4.1 (f) below, a ball that passes above head height of the batsman, that prevents him from being able to hit it with his bat by means of a normal cricket stroke shall be called a wide.
- e) For the avoidance of doubt any fast short pitched delivery that is called a wide under this playing condition shall also count as one of the allowable short pitched deliveries in that over.
- f) In the event of a bowler bowling more than two fast short-pitched deliveries in an over as defined in clause 42.4.1 (b) above, the umpire at the bowler's end shall call and signal no ball on each occasion. A differential signal shall be used to signify a fast short pitched delivery. The umpire shall call and signal 'no ball' and then tap the head with the other hand.
- g) If a bowler delivers a third fast short pitched ball in an over, the umpire, after the call of no ball and when the ball is dead, shall caution the bowler, inform the other umpire, the captain of the fielding side and the batsmen at the wicket of what has occurred. This caution shall apply throughout the innings.
- h) If there is a second instance of the bowler being no balled in the innings for bowling more than two fast short pitched deliveries in an over, the umpire shall advise the bowler that this is his final warning for the innings.
- i) Should there be any further instance by the same bowler in that innings, the umpire shall call and signal no ball and when the ball is dead direct the captain to take the bowler off forthwith.
If necessary, the over shall be completed by another bowler, who shall neither have bowled the previous over, or part thereof, nor be allowed to bowl the next over, or part thereof.
- j) The bowler thus taken off shall not be allowed to bowl again in that innings.
- k) The umpire will report the occurrence to the other umpire, the batsmen at the wicket and as soon as possible to the captain of the batting side.
- l) The umpires will then report the matter to the ICC Match Referee who shall take such action as is considered appropriate against the captain and the bowler concerned. (Refer also to Law 42.1 Fair and Unfair Play - Responsibility of the Captains.)

The above is not a substitute for clause 42.5 below which umpires are able to apply at any time.

42.4.2 Law 42.6 (b) Bowling of High Full Pitched Balls

Law 42.6 (b) shall be replaced by the following:

- a) Any delivery, which passes or would have passed on the full above waist height of the striker standing upright at the popping crease is deemed unfair, whether or not it is likely to inflict physical injury on the striker.
- b) In the event of a bowler bowling a high full pitched ball as defined in clause 42.4.2 (a) above, the umpire at the bowler's end shall call and signal no ball.

If, in the opinion of the umpire, such a delivery is considered likely to inflict physical injury on the batsman, the umpire at the bowler's end shall, in addition to calling and signalling no ball, when the ball is dead, caution the bowler and issue a first and final warning. The umpire shall inform the other umpire, the captain of the fielding side and the batsmen at the wicket of what has occurred.

- c) Should there be any further instance (where a high full pitched ball is bowled and is considered likely to inflict physical injury on the batsman) by the same bowler in that innings, the umpire shall, in addition to calling and signalling no ball, when the ball is dead, direct the captain to take the bowler off forthwith. If necessary, the over shall be completed by another bowler, who shall neither have bowled the previous over, or part thereof, nor be allowed to bowl the next over, or part thereof.
- d) The bowler thus taken off shall not be allowed to bowl again in that innings.
- e) The umpire will report the occurrence to the other umpire, the batsman at the wicket and as soon as possible to the captain of the batting side.
- f) The umpires will then report the matter to the ICC Match Referee who shall take such action as is considered appropriate against the captain and the bowler concerned. (Refer also to Law 42.1 Fair and Unfair Play - Responsibility of the Captains.)

42.5 Law 42.7 - Dangerous and Unfair Bowling - Action by the umpire

Law 42.7 shall be replaced by the following:

Regardless of any action taken by the umpire as a result of a breach of clauses 42.4.1, 42.4.2 and 42.6 the following shall apply at any time during the match.

- 42.5.1 The bowling of fast short pitched balls is unfair if in the opinion of the umpire at the bowler's end he considers that by their repetition and taking into account their length, height and direction, they are likely to inflict physical injury on the striker, irrespective of the protective clothing and equipment he may be wearing. The relative skill of the striker shall also be taken into consideration.
- 42.5.2 In the event of such unfair bowling, the umpire at the bowler's end shall adopt the following procedure:
 - a) In the first instance the umpire shall call and signal no ball, caution the bowler and inform the other umpire, the captain of the fielding side and the batsmen of what has occurred.

- b) If this caution is ineffective, he shall repeat the above procedure and indicate to the bowler that this is a final warning.
- c) Both the above caution and final warning shall continue to apply even though the bowler may later change ends.
- d) Should there be any further instance by the same bowler in that innings, the umpire shall call and signal no ball and when the ball is dead direct the captain to take the bowler off forthwith. If necessary, the over shall be completed by another bowler, who shall neither have bowled the previous over, or part thereof, nor be allowed to bowl the next over, or part thereof. See Law 22.8. (Bowler Incapacitated or Suspended during an Over).
- e) The bowler thus taken off shall not be able to bowl again in that innings.
- f) The umpire will report the occurrence to the other umpire, the batsmen at the wicket and as soon as possible to the captain of the batting side.
- g) The umpires will then report the matter to the ICC Match Referee who shall take such action as is considered appropriate against the captain and the bowler concerned. (Refer also to Law 42.1 Fair and Unfair Play - Responsibility of the Captains.)

42.6 Law 42.8 - Deliberate bowling of High Full Pitched Balls

Law 42.8 shall be replaced by the following:

If the umpire considers that a high full pitch delivery which is deemed unfair as defined in clause 42.4.2 was deliberately bowled, then the caution and warning process shall be dispensed with.

The umpire at the bowler's end shall:

- 42.6.1 Call and signal no ball.
- 42.6.2 When the ball is dead, direct the captain to take the bowler off forthwith.
- 42.6.3 Not allow the bowler to bowl again in that innings.
- 42.6.4 Ensure that the over is completed by another bowler, provided that the bowler does not bowl two overs or part thereof consecutively.
- 42.6.5 Report the occurrence to the other umpire, to the captain of the batting side and, together with the other umpire, to the ICC Match Referee who shall take such action as is considered appropriate against the captain and the bowler concerned. (Refer also to Law 42.1 Fair and Unfair Play Responsibility of the Captains).

42.7 Action by the umpires for dangerous and unfair Bowling

Should the umpires initiate the caution and warning procedures set out in clauses 42.4.1, 42.4.2, 42.5 and 42.6 such cautions and warnings are not to be cumulative.

42.8 Law 42.9 - Time Wasting by the Fielding Side

Law 42.9 shall apply subject to Law 42.9 (c) being replaced by the following:

If either umpire considers that there is any further waste of time in that innings, by any member of the fielding side the umpire concerned shall:

- 42.8.1 Call and signal dead ball if necessary, and;
- 42.8.2 Award 5 penalty runs to the batting side (see Law 42.17).
- 42.8.3 Inform the other umpire, the batsmen at the wicket and as soon as possible the captain of the batting side of what has occurred.
- 42.8.4 Together with the other umpire, report the occurrence to the ICC Match Referee who shall take such action as is considered appropriate against the captain and the team concerned under the ICC Code of Conduct.

42.9 Law 42.10 - Batsman Wasting Time

Law 42.10 shall apply, subject to the following:

If the incoming batsman is not in position to take guard or his partner not ready to receive the next ball within 2 minutes of the fall of the previous wicket, the action should be regarded by the umpires as time wasting and the provisions of Law 42.10 shall apply.

In addition, the umpires will report the incident to the ICC Match Referee under the ICC Code of Conduct.

42.10 Law 42.14 Batsman damaging the pitch

Law 42.14 shall apply.

See also clause 37 above.

42.11 Law 42.15 – Bowler attempting to run out non-striker before delivery

Law 42.15 shall be replaced by the following:

The bowler is permitted, before releasing the ball and provided he has not completed his usual delivery swing, to attempt to run out the non-striker. Whether the attempt is successful or not, the ball shall not count as one of the over. If the bowler fails in an attempt to run out the non-striker, the umpire shall call and signal Dead ball as soon as possible.

42.12 Use of Electronic Communications Equipment

The use of electronic communication devices and equipment of any kind to communicate with players on the field of play shall not be permitted.

APPENDIX 1

All penalty runs in the Laws of Cricket (2000 Code 5th Edition - 2013) now apply in International Cricket. Some penalty runs can be referred to the ICC Match Referee for further action if necessary.

APPENDIX 2

Decision Review System (DRS) - Playing Conditions

1 GENERAL

- 1.1 The DRS includes:
 - The process for the referral by the on-field umpires of a decision to the third umpire and/or the consultation process (between the on-field umpire(s) and the third umpire) initiated by the on-field umpire(s) as set out in paragraph 2 below and which have been collectively termed in these playing conditions as an “Umpire Review”; and
 - The process initiated by the players for the review of an on-field umpire’s decision (by means of a consultation between the on-field umpire(s) and the third umpire) as set out in paragraph 3 below and which has been termed in these playing conditions as the “Player Review”.
- 1.2 The Home Board will be required to ensure that the television technology specifications set out in Appendix 3 are provided.
- 1.3 In particular, the Home Board is to ensure that a separate room is provided for the third umpire and that he has access to the television equipment and technology as specified in Appendix 3 so as to be in the best position to facilitate the referral and/or consultation processes referred to in paragraphs 2 (Umpire Review) and 3 (Player Review) below.
- 1.4 The ICC shall appoint an independent technology expert (ICC Technical Official) to be present at every series to assist the third umpire and to protect the integrity of the DRS process.

2 UMPIRE REVIEW

In the circumstances detailed in paragraphs 2.1, 2.2, 2.3, 2.4 and 2.5 below, the on-field umpire has the discretion to refer the decision to the third umpire or, in the case of 2.2.(a), 2.4 and 2.5, to consult with the third umpire before making the decision and should take a common sense approach.

Save for requesting the umpire to review his decision under paragraph 3 (Player Review) below, players may not appeal to the umpire to use the Umpire Review - breach of this provision would constitute dissent and the player could be liable for discipline under the ICC Code of Conduct.

The third umpire shall call for as many replays from any camera angle as is necessary to reach a decision. As a guide, a decision should be made within 30 seconds whenever possible, but the third umpire shall have the discretion to take more time.

2.1 Run Out, Stumping and Hit Wicket Decisions

- a) The on-field umpire shall be entitled to refer an appeal for a run-out, stumping or hit wicket to the third umpire.
- b) An on-field umpire wishing to refer a decision to the third umpire shall signal to the third umpire by making the shape of a TV screen with his hands.
- c) In the case of a referral of a hit wicket or stumping decision, the third umpire shall first check the fairness of the delivery (foot-fault, bowler breaking the wicket, waist high full tosses, bouncers above shoulder height). If the delivery was not a fair delivery he shall indicate that the batsman is not out and advise the on-field umpire to signal no ball. See also paragraph 3.10 below.

- d) If the third umpire decides the batsman is out a red light is displayed; a green light means not-out. Should the third umpire be temporarily unable to respond, a white light (where available) will remain illuminated throughout the period of interruption to signify to the on-field umpires that the TV replay system is temporarily unavailable, in which case the decision will be taken by the on-field umpire. (As an alternative to the red/green light system and where available, the big replay screen may be used for the purpose of conveying the third umpire's decision.)
- e) When reviewing the TV replay(s), if the third umpire believes that the batsman may instead be out by any other mode of dismissal, beyond that initially consulted upon, he shall initiate the process described in paragraph 3.3 below as if the batsman has been given not out. This will not count as a Player Review for the purposes of paragraph 3.5.

2.2 Caught Decisions

In the event of an appeal for a caught decision:

a) Clean Catches

- i) Should the bowler's end umpire be unable to decide whether or not a catch was taken cleanly, he shall first consult with the square leg umpire.
- ii) Should both on-field umpires be unable to make a decision, they may consult by two-way radio with the third umpire. Following such consultation, the final decision will be made and given by the bowler's end umpire, who will take into account the on-field umpires' initial views and any other advice received from the third umpire.
- iii) The third umpire has to determine whether the batsman has been caught. However, in reviewing the television replay(s), the third umpire shall first check the fairness of the delivery (foot-fault, bowler breaking the wicket, waist high full tosses, bouncers above shoulder height) and whether the batsman has hit the ball. If the delivery was not a fair delivery or if it is clear to the third umpire that the batsman did not hit the ball he shall indicate to the on-field umpire that the batsman is not out caught, and in the case of an unfair delivery, advise the on-field umpire to signal no ball. See also paragraph 3.10 below.
- iv) When reviewing the TV replay(s), if the third umpire believes that the batsman may instead be out by any other mode of dismissal, beyond that initially consulted upon, he shall initiate the process described in paragraph 3.3 below as if the batsman has been given not out. This will not count as a Player Review for the purposes of paragraph 3.5.

b) Bump Ball

- i) Should the bowler's end umpire be unable to decide whether a catch was taken from a bump ball or not, he shall first consult with the square leg umpire.
- ii) Should both on-field umpires be unable to make a decision, the bowler's end umpire shall be entitled to refer the decision to the third umpire to review a TV replay(s) of the batsman's stroke as in paragraph 2.1 (b).

- iii) The third umpire has to determine whether the ball was a bump ball or not. However, in reviewing the television replay(s), the third umpire shall first check the fairness of the delivery (foot fault and bowler breaking the wicket) and whether the batsman has hit the ball. If the delivery was not a fair delivery or if it is clear to the third umpire that the batsman did not hit the ball he shall indicate that the batsman is not out and, in the case of an unfair delivery, advise the on-field umpire to signal no ball. See also paragraph 3.10 below.
- iv) The third umpire shall communicate his decision by the system as in paragraph 2.1 (d).
- v) When reviewing the TV replay(s), if the third umpire believes that the batsman may instead be out by any other mode of dismissal, beyond that initially consulted upon, he shall initiate the process described in paragraph 3.3 below as if the batsman has been given not out. This will not count as a Player Review for the purposes of paragraph 3.5.

2.3 Boundary Decisions

- a) The on-field umpire shall be entitled to refer to the third umpire for a decision about whether the fieldsman had any part of his person in contact with the ball when he touched the boundary or when he had any part of his person grounded beyond the boundary, or whether a four or six had been scored. A decision is to be made immediately and cannot be changed thereafter.

Note: If the television evidence is inconclusive as to whether or not a boundary has been scored, the status quo will remain, and it shall be treated as runs scored by the batting side.

- b) An on-field umpire wishing the assistance of the third umpire in this circumstance shall communicate with the third umpire by use of a two-way radio and the third umpire will convey his decision to the on-field umpire by this method.
- c) The third umpire may initiate contact with the on-field umpire by two-way radio if TV coverage shows a boundary line infringement or incident that appears not to have been acted upon by the on-field umpires.

2.4 Obstructing the Field

- a) Following an appeal from the fielding side, the on-field umpire shall be entitled to consult with the third umpire if he feels that the batsman, in running between the wickets, may have significantly changed his direction (refer clause 37).
- b) Such consultation shall be initiated by the on-field umpire and will be done to help him decide the extent of any change in direction and whether the obstruction was wilful or not.
- c) Following such consultation with the third umpire, the final decision shall be indicated in the normal fashion by the relevant on-field umpire.

2.5 Batsmen Running to the Same End

- a) In the event of both batsmen running to the same end and the umpires are uncertain over which batsmen made his ground first, the on-field umpire may consult with the third umpire.
- b) The procedure in paragraph 2.3 (b) shall apply.

3 PLAYER REVIEW

The following clauses shall operate in addition to and in conjunction with paragraph 2 (Umpire Review).

3.1 Circumstances in which a Player Review may be requested

- a) A player may request a review of any decision taken by the on-field umpires concerning whether or not a batsman is dismissed, with the exception of 'Timed Out' (Player Review).
- b) For the avoidance of doubt, no other decisions made by the umpires are eligible for a Player Review.
- c) Only the batsman involved in a dismissal may request a Player Review of an 'Out' decision and only the captain (or acting captain) of the fielding team may request a Player Review of a 'Not Out' decision.
- d) A decision concerning whether or not a batsman is dismissed that could have been the subject of a Umpire Review under paragraph 2 is eligible for a Player Review as soon as it is clear that the on-field umpire has chosen not to initiate the Umpire Review.

3.2 The manner of requesting the Player Review

- a) The request should be made by the player making a 'T' sign with both forearms at head height.
- b) The total time elapsed between the ball becoming dead and the review request being made should be no more than 15 seconds. The on-field umpire should provide the player with a prompt after 10 seconds if the request has not been made at that time and the player should request the review immediately thereafter. If the umpires believe that a request has not been made within the 15 second time frame, they will decline to review the decision.
- c) The captain may consult with the bowler and other fielders or the two batsmen may consult with each other prior to deciding whether to request a Player Review. However in order to meet the requirement of (b) above, such consultation will need to occur almost instantly and be very brief. Under no circumstances is any player permitted to query an umpire about any aspect of a decision before deciding on whether or not to request a Player Review. If the umpires believe that the captain or batsman has received direct or indirect input emanating other than from the players on the field, then they may at their discretion decline the request for a Player Review. In particular, signals from the dressing room must not be given.
- d) No replays, either at normal speed or slow motion, should be shown on a big screen to spectators until the time allowed for the requesting of a Player Review has elapsed. See also paragraph 3.11 below.
- e) If either on-field umpire initiates an Umpire Review under paragraph 2, this does not preclude a player seeking a Player Review of a separate incident from the same delivery. The Player Review request may be made after the Umpire Review provided it is still within the timescale described in (b) above. (See 3.8 (b) and 3.8 (c) below for the process for addressing both an Umpire and Player Review).
- f) A request for a Player Review may not be withdrawn once it has been made.

3.3 The process of consultation

- a) On receipt of an eligible and timely request for a Player Review, the on-field umpire will make the sign of a television with his hands in the normal way.
- b) He will initiate communication with the third umpire by confirming the decision that has been made and that the player has requested a Player Review.
- c) The third umpire must then work alone, independent of outside help or comment, other than when consulting the on-field umpire.
- d) A two-way consultation process should begin to investigate whether there is anything that the third umpire can see or hear which would indicate that the on-field umpire should change his decision.
- e) This consultation should be on points of fact, where possible phrased in a manner leading to yes or no answers. Questions requiring a single answer based on a series of judgements, such as “do you think that was LBW?” are to be avoided.
- f) The third umpire shall not withhold any factual information which may help in the decision making process, even if the information is not directly prompted by the on-field umpire’s questions. In particular, in reviewing a dismissal, if the third umpire believes that the batsman may instead be out by any other mode of dismissal, he shall advise the on-field umpire accordingly. The process of consultation described in this paragraph in respect of such other mode of dismissal shall then be conducted as if the batsman has been given not out.
- g) The third umpire should initially check whether the delivery is fair (foot-fault, bowler breaking the wicket, waist high full tosses, bouncers above shoulder height) where appropriate advising the on-field umpire accordingly. See also paragraph 3.10 below.
- h) If despite the available technology, the third umpire is unable to answer with a high degree of confidence a particular question posed by the on-field umpire, then he should report that the replays are ‘inconclusive’. The third umpire should not give answers conveying likelihoods or probabilities.
- i) Subject to paragraph 3.3 (j) below, specifically when advising on LBW decisions, the requirement for a high degree of confidence should be interpreted as follows:
 - i) With regard to determining the point of pitching the evidence provided by technology should be regarded as definitive and the Laws as interpreted in clause 3.9 (a) below should be strictly applied.
 - ii) With regard to the point of impact
 - If a ‘not out’ decision is being reviewed, in order to report that the point of impact is between wicket and wicket (i.e. in line with the stumps), the evidence provided by technology should show that the centre of the ball at the moment of interception is in line within an area demarcated by a line drawn down the middle of the outer stumps.
 - If an ‘out’ decision is being reviewed, in order to report that the point of impact is not between wicket and wicket (i.e. outside the line of the stumps), the evidence provided by technology should show that no part of the ball at the moment of interception is between wicket and wicket.

iii) With regard to determining whether the ball was likely to have hit the stumps:

- If a 'not out' decision is being reviewed, in order to report that the ball is hitting the stumps, the evidence provided by technology should show that the centre of the ball would have hit the stumps within an area demarcated by a line drawn below the lower edge of the bails and down the middle of the outer stumps.

However, where the evidence shows that the ball would have hit the stumps within the demarcated area as set out above but that:

- The point of impact is 300cm or more from the stumps; or
- The point of impact is more than 250cm but less than 300cm from the stumps and the distance between point of pitching and point of impact is less than 40cm,

the original decision will stand (i.e. not out).

- If an 'out' decision is being reviewed, in order to report that the ball is missing the stumps, the evidence of the technology should show that no part of the ball would have made contact with any part of the stumps or bails.

- j) In circumstances where the television technology (all or parts thereof) is not available to the third umpire or fails for whatever reason, the third umpire shall advise the on-field umpire of this fact but still provide any relevant factual information that may be ascertained from the available television replays and other technology. See also paragraph 3.5 (d).
- k) The on-field umpire must then make his decision based on those factual questions that were answered by the third umpire, any other factual information offered by the third umpire and his recollection and opinion of the original incident.
- l) The on-field umpire will reverse his decision if the nature of the supplementary information received from the third umpire leads him to conclude that his original decision was incorrect.

3.4 The process for communicating the final decision

- a) When the on-field umpire has reached a decision, he should advise the TV director (directly or via the third umpire).
- b) For Player Reviews concerning potential dismissals, he should then indicate "Out" by raising his finger above his head in a normal yet prominent manner or indicate "Not Out" by the call of 'not out' and by crossing his hands in a horizontal position side to side in front and above his waist three times (as per a 'safe' decision in baseball). Where the decision is a reversal of the on-field umpire's previous decision, he should make the 'revoke last signal' indication immediately prior to the above.
- c) If the mode of dismissal is not obvious or not the same as that on which the original decision was based, then the umpire should advise the official scorers via the third umpire.

3.5 Number of Player Review requests permitted

The following trial playing condition is mandatory in all Test Matches where DRS is being used for the period 1st October 2013 to 30th April 2014:

Subject to the provisions of clauses a) to g) below, each team will have two unsuccessful player review requests remaining immediately after the completion of the 80th over of the innings. For the sake of clarity, at the end of the 80th over a team with no remaining player reviews receives 2 additional reviews; a team with 1 remaining player review receives 1 additional review, and a team with 2 remaining player reviews receives no additional reviews.

- a) Subject to the above, each team is allowed to make a maximum of two unsuccessful player review requests in the first 80 overs of the innings, and a maximum of two unsuccessful player review requests after 80 overs for the remainder of the innings. If a player review results in the umpire reversing his original decision, then the request has been successful and does not count towards the innings limit. If the umpire's decision is unchanged, the player review is unsuccessful. After two unsuccessful requests by one team within the first 80 overs, no further player review requests will be allowed by that team until after 80 overs. After two unsuccessful requests by one team, both made after the first 80 overs, no further player review requests will be allowed by that team during the remainder of that innings.
- b) If following a Player Review, an umpire upholds a decision of 'Out', but for a different mode of dismissal from that for which the original decision was given, then the request will still be regarded as unsuccessful.
- c) If following a Player Review, an umpire upholds a decision of 'Not Out' on account of the delivery being a no ball for any reason, thereby not requiring any review of the ball's subsequent trajectory, then this will not be counted as an unsuccessful request and not count towards the innings limit.
- d) If a Player Review and an Umpire Review occur from the same delivery and the decision from the Umpire Review renders the Player Review unnecessary (see 3.8 (b) and 3.8 (c)), then the Player Review request will be ignored and not be counted as unsuccessful.
- e) An unsuccessful review may be re-instated by the Match Referee at his sole discretion (if appropriate after consultation with the ICC Technical Official and/or the television broadcast director), if the review could not properly be concluded due to a failure of the technology. Any such decision shall be final and should be taken as soon as possible once all the relevant facts have been ascertained by the Match Referee. An unsuccessful review shall not be re-instated if, despite any technical failures, the correct decision could still have been made using the other available technology. Similarly, no reinstatement shall be made where the technology worked as intended, but the evidence gleaned from its use was "inconclusive".
- f) The third umpire shall be responsible for counting the number of unsuccessful player reviews and advising the on-field umpires once either team has exhausted their allowance either for the first 80 overs or for the innings.
- g) The scoreboard shall display, for the innings in progress, the number of Player Reviews remaining available to each team.

3.6 Dead ball

- a) If following a Player Review request, an original decision of 'Out' is changed to 'Not Out', then the ball is still deemed to have become dead when the original decision was made (as per Law 23.1(a)(iii)). The batting side, while benefiting from the reversal of the dismissal, will not benefit from any runs that may subsequently have accrued from the delivery had the on-field umpire originally made a 'Not Out' decision, other than any No Balls penalty that could arise under 3.3 (g) above.
- b) If an original decision of 'Not Out' is changed to 'Out', the ball will retrospectively be deemed to have become dead from the moment of the dismissal event. All subsequent events, including any runs scored, are ignored.

3.7 Use of technology

- a) The following technology may be used by the third umpire.
 - Slow motion replays from all available cameras
 - Super slow motion replays from all available cameras
 - Ultra motion camera replays from all available cameras
 - Sound from the stump microphones with the replays at normal speed and slow motion
 - Approved ball tracking technology
 - The mat, generated by the provider of ball tracking technology, not by the broadcaster
 - Hot Spot cameras

In addition, other forms of technology may be used subject to ICC being satisfied that the required standards of accuracy and time efficiency can be met.

- b) Where practical usage or further testing indicates that any of the above forms of technology cannot reliably provide accurate and timely information, then it may be removed prior to or during a match. The final decision regarding the technology to be used in a given match will be taken by the ICC Match Referee in consultation with the ICC Technical Official, ICC Management and the competing teams' governing bodies.

3.8 Combining Umpire Reviews with Player Reviews

- a) If an Umpire Review (under Clause 2) and a Player Review request are made following the same delivery but relating to separate modes of dismissal, the following procedure shall apply.
- b) The Umpire Review should be carried out prior to the Player Review if **all** of the following conditions apply:
 - i) The Player Review has been requested by the fielding side
 - ii) The Umpire Review and the Player Review both relate to the dismissal of the same batsman
 - iii) If the batsman is out, the number of runs scored from the delivery would be the same for both modes of dismissal
 - iv) If the batsman is out, the batsman on strike for the next delivery would be the same for both modes of dismissal.

- c) If the Umpire Review leads the third umpire to make a decision of 'Out', then this will be displayed in the usual manner and the Player Review will not be performed. If the Umpire Review results in a not out decision, then the third umpire will make no public decision but proceed to address the Player Review request.

For illustration, following an unsuccessful lbw appeal, the striker sets off for a run, is sent back and there is an appeal for his run out. The players request that the lbw decision is reviewed and the umpires request that the run out be reviewed. The four criteria above are satisfied, so the run out referral is determined first. Should the appeal for run out be 'Out', then there is no requirement for the lbw review to take place.

- d) In all other circumstances, the two incidents shall be addressed in chronological order. If the conclusion from the first incident is that a batsman is dismissed, then the ball would be deemed to have become dead at that point, rendering investigation of the second incident unnecessary.

3.9 Interpretation of Laws

- a) When using technology to determine where the ball pitched (as per Law 36.1(b)), the third umpire should refer to the "point" (or centre) of the ball. Therefore if at least 50% of the ball pitches outside the line of leg stump, then no LBW dismissal is possible.
- b) When using a replay to determine the moment at which the wicket has been put down (as per Law 28.1), the third umpire should deem this to be the first frame in which one of the bails is shown (or can be deduced) to have lost **all** contact with the top of the stumps and subsequent frames show the bail permanently removed from the top of the stumps.

3.10 No Balls

Following any mode of dismissal that is not permitted off a no ball and which is not the subject of an Umpire or Player Review, if the on-field umpire is uncertain as the fairness of the delivery (foot-fault, bowler breaking the wicket, waist high full tosses, bouncers above shoulder height), he shall be entitled to request the batsman to delay leaving the field and to check the fairness of the delivery with the third umpire. Consultation with the third umpire shall be by way of two way radio. If the delivery was not a fair delivery the on-field umpire shall indicate that the batsman is not-out and signal no-ball. For the avoidance of doubt, the third umpire shall apply clause 24.2 when deciding whether a no-ball should have been called.

3.11 Big Screen Policy

The current ICC big screen policy will apply.

See also 3.2(d)

APPENDIX 3

DRS Third Umpire Room and Television Broadcast Specifications

Specifications will be circulated separately.

APPENDIX 4

Third Umpire TV Replay System – Playing Conditions

1 GENERAL

- 1.1 Save with the express written consent of the Chief Executive Officer of the ICC the Home Board will ensure the live television broadcast of all Test Matches played in its country.
- 1.2 Where matches are broadcast the camera specification set out in Appendix 5 A shall be mandatory as a minimum requirement.
- 1.3 Where matches are not broadcast the camera specifications set out in Appendix 5 B shall be mandatory as a minimum requirement.
- 1.4 The Home Board will ensure a separate room is provided for the third umpire and that he has access to television monitors and direct sound link with the television control broadcast director to facilitate as many replays as is necessary to assist him in making a decision.
- 1.5 In the circumstances detailed in paragraphs 2, 3, 4, 5 and 6 below, the on-field umpire has the discretion to refer the decision to the third umpire or, in the case of paragraph 3.1, 5 and 6, to consult with the third umpire before making his decision and should take a common sense approach.

Players may not appeal to the umpire to use the replay system - breach of this provision would constitute dissent and the player could be liable for discipline under the ICC Code of Conduct.
- 1.6 The third umpire shall call for as many replays from any camera angle as is necessary to reach a decision. As a guide, a decision should be made within 30 seconds whenever possible, but the third umpire shall have a discretion to take more time in order to finalise a decision.
- 1.7 The third umpire shall only have access to TV replays for the provisions of paragraphs 2, 3, 4, 5 and 6 below. Other technology which may be in use by the broadcaster for broadcast purposes (Hot Spot, ball tracking, Snicko) shall not be permitted.

2 RUN OUT, STUMPING AND HIT WICKET DECISIONS

- 2.1 The on-field umpire shall be entitled to refer an appeal for a run-out, stumping or hit wicket to the third umpire.
- 2.2 An on-field umpire wishing to refer a decision to the third umpire shall signal to the third umpire by making the shape of a TV screen with his hands.
- 2.3 If the third umpire decides the batsman is out a red light is displayed; a green light means not-out. Should the third umpire be temporarily unable to respond, a white light (where available) will remain illuminated throughout the period of interruption to signify to the on-field umpires that the TV replay system is temporarily unavailable, in which case the decision will be taken by the on-field umpire. (As an alternative to the red/green light system and where available, the big screen may be used for the purpose of conveying the third umpire's decision.)
- 2.4 When reviewing the TV replay(s), the third umpire shall first check the fairness of the delivery (foot fault, bowler breaking the wicket, waist high full tosses, bouncers above shoulder height). Additionally, if the third umpire finds the batsman is out by another mode of dismissal (excluding LBW), or not out by any mode of dismissal (excluding LBW), he shall notify the on-field umpire so that the correct decision is made.

3 CAUGHT DECISIONS

The on-field umpire shall be entitled to refer an appeal for a caught decision to the third umpire in the following circumstances:

3.1 Clean Catches

- a) Should the bowler's end umpire be unable to decide whether or not a catch was taken cleanly, he shall first consult with the square leg umpire.
- b) Should both umpires be unable to make a decision, they may consult by two-way radio with the third umpire. Following such consultation, the final decision will be made and given by the bowler's end umpire, who will take into account the on-field umpires' initial views and any other advice received from the third umpire.
- c) The third umpire has to determine whether the batsman has been caught. However, when reviewing the television replay(s), the third umpire shall first check the fairness of the delivery (foot fault, bowler breaking the wicket, waist high full tosses, bouncers above shoulder height). Additionally, if it is clear to the third umpire that the batsman is out by another mode of dismissal (excluding LBW), or not out by any mode of dismissal (excluding LBW), he shall notify the on-field umpire so that the correct decision is made.
- d) The final decision shall be indicated in the normal fashion by the bowler's end umpire.

3.2 Bump Ball

- a) Should the bowler's end umpire be unable to decide whether a catch was taken from a bump ball or not, he shall first consult with the square leg umpire.
- b) Should both on-field umpires be unable to make a decision, the bowler's end umpire shall be entitled to refer the decision to the third umpire to review a TV replay(s) of the batsman's stroke as in paragraph 2.2.
- c) The third umpire has to determine whether the ball was a bump ball or not. However, when reviewing the television replay(s), the third umpire shall first check the fairness of the delivery (foot fault and bowler breaking the wicket). Additionally, if it is clear to the third umpire that the batsman is out by another mode of dismissal (excluding LBW), or not out by any mode of dismissal (excluding LBW), he shall notify the on-field umpire so that the correct decision is made.
- d) The third umpire shall communicate his decision by the system as in paragraph 2.3.

4 BOUNDARY DECISIONS

- 4.1 The on-field umpire shall be entitled to refer to the third umpire for a decision about whether the fieldsman had any part of his person in contact with the ball when he touched the boundary or when he had any part of his person grounded beyond the boundary, or whether a four or six had been scored. A decision is to be made immediately and cannot be changed thereafter.
- 4.2 An on-field umpire wishing the assistance of the third umpire in this circumstance shall communicate with the third umpire by use of a two-way radio and the third umpire will convey his decision to the on-field umpire by this method.

- 4.3 The third umpire may initiate contact with the on-field umpire by two-way radio if TV coverage shows a boundary line infringement or incident that appears not to have been acted upon by the on-field umpires.

5 OBSTRUCTING THE FIELD

- 5.1 Following an appeal from the fielding side, the on-field umpire shall be entitled to consult with the third umpire if he feels that the batsman, in running between the wickets, may have significantly changed his direction (refer clause 37).
- 5.2 Such consultation shall be initiated by the on-field umpire and will be done to help him decide the extent of any change in direction and whether the obstruction was wilful or not.
- 5.3 Following such consultation with the third umpire, the final decision shall be indicated in the normal fashion by the relevant on-field umpire.

6 BATSMEN RUNNING TO THE SAME END

- 6.1 In the event of both batsmen running to the same end and the umpires are uncertain over which batsman made his ground first, the on-field umpire may consult with the third umpire.
- 6.2 The procedure in paragraph 4.2 shall apply.

7 NO BALLS

Following any mode of dismissal that is not permitted off a no ball, if the on-field umpire is uncertain as the fairness of the delivery (foot-fault, bowler breaking the wicket, waist high full tosses, bouncers above shoulder height), he shall be entitled to request the batsman to delay leaving the field and to check the fairness of the delivery with the third umpire. Consultation with the third umpire shall be by way of two way radio. If the delivery was not a fair delivery the on-field umpire shall indicate that the batsman is not-out and signal no-ball. For the avoidance of doubt, the third umpire shall apply clause 24.2 when deciding whether a no-ball should have been called.

APPENDIX 5A

Generic Camera Layout - Basic TV Coverage

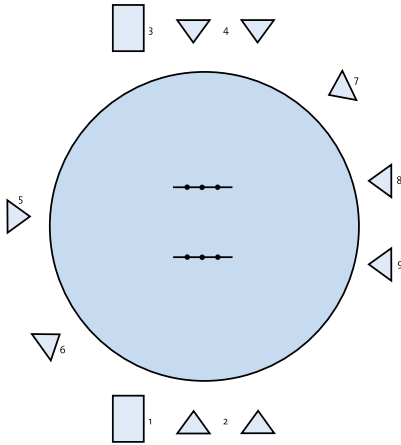

- 1 Wicket to Wicket
- 2 Follow
- 3 Wicket to Wicket
- 4 Follow
- 5 Square Leg/Mid Wicket
- 6 Slips
- 7 Slips
- 8 Line / Run out Cam
- 9 Line / Run out Cam

APPENDIX 5B

Generic Camera Layout - Third Umpire Coverage

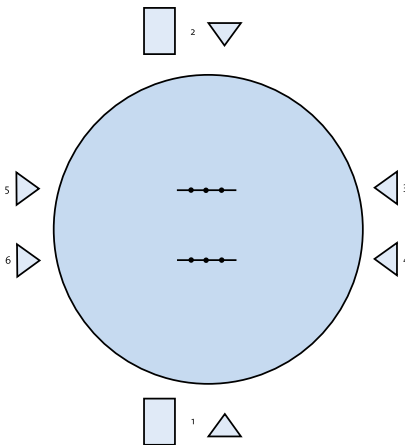

- 1 Follow
- 2 Follow
- 3 Line / Run out Cam
- 4 Line / Run out Cam
- 5 Line / Run out Cam
- 6 Line / Run out Cam

APPENDIX 6**Calculation Template for Last Day of Test Match**

This template applies to any interruption on the last day which causes a loss in actual playing time, (i.e. an interruption longer than the amount of extra time available) and where play resumes after the scheduled tea interval.

Where play resumes prior to tea, then the calculation of overs remaining in the day is performed as per Days 1-4, with the scheduled time for the last hour affected only by the adding of any extra time.

Lines A, B, C, D and E should be completed at the start of an interruption on the final day. If play resumes without any lost playing time, or prior to the tea interval, then this sheet can be discarded.

Once the length of interruption exceeds D and actual playing time is lost, then line F can be completed

Lines G and H can be completed immediately if the interruption starts after tea, otherwise as soon as the interruption includes the tea interval.

- A Start of interruption _____
- B Minimum overs remaining before start of last hour as at time A
(See Note 1) _____
- C Time required to bowl minimum overs @ 4 mins per over ($B \times 4$) _____
- D Extra time available as at time A _____
- E Scheduled time for last hour as at time A _____
- F Rescheduled time for last hour (Time basis) ($D + E$) _____
- G Length of intervals covered by interruption:
enter 40 (lunch), 20 (tea), 60 (both) or 0 (neither) _____
- H Rescheduled time for last hour (Overs basis) ($A + C + D + G$) _____
- I Later of F and H above _____
- J Time play resumes _____

Case A: If J is earlier than I, play resumes prior to the last hour

K Minutes playing time lost ($J - A - D - G$) _____

L Overs lost @ 4 mins per over (see Note 2)

M Minimum overs before start of last hour ($B - L$) (See Note 1)
The last hour then starts at the later of the time in Line F
and the completion of the overs in Line M _____

Case B: If J is not earlier than I, play resumes in the last hour

K Time for last hour to finish (I plus 60 minutes) _____

L Minutes remaining in last hour ($K - J$) _____

M Overs remaining in last hour ($L / 4$ mins or part thereof)
(See Note 1) _____

Note 1: If an interruption occurs part-way through an over, in Row B enter the number of full overs remaining, ignoring the part over. Then in Row M, add back the part over to the minimum overs to be bowled on resumption.

Note 2: The actual overs lost for a given interruption will also reflect any earlier interruptions in the day, so that one over is lost in the day for each full four minutes of aggregated playing time lost. For example, 15 minutes loses 3 overs, but another 15 minute delay loses 4 overs.

STANDARD **ONE-DAY INTERNATIONAL**
MATCH PLAYING CONDITIONS

STANDARD ONE-DAY INTERNATIONAL MATCH PLAYING CONDITIONS

These playing conditions are applicable to all ODI matches from 1st October 2013 and supersede the previous version dated 30 April 2013. Included in this version are amendments to clauses 1.3, 2.2.2, 17.1, 17.2, 19.3, 23.1, 42.1, 42.1.1, Appendices 3, 7 and 9, and new clauses 5.1.3, 8.2, 12.1.3, 24.3, 42.1.2 and Appendices 2, 7, 8 and 10.

Except as varied hereunder, the Laws of Cricket (2000 Code 5th Edition - 2013) shall apply.

Note: All references to 'Governing Body' within the Laws of Cricket shall be replaced by 'ICC Match Referee'.

1 LAW 1 THE PLAYERS

1.1 Law 1.1 - Number of Players

Law 1.1 shall be replaced by the following:

A match is played between two sides. Each side shall consist of 11 players, one of whom shall be captain.

1.2 Law 1.2 - Nomination of Players

Law 1.2 shall be replaced by the following:

- 1.2.1 Each captain shall nominate 11 players plus a maximum of 4 substitute fielders in writing to the ICC Match Referee before the toss. No player (member of the playing eleven) may be changed after the nomination without the consent of the opposing captain.
- 1.2.2 Only those nominated as substitute fielders shall be entitled to act as substitute fielders during the match, unless the ICC Match Referee, in exceptional circumstances, allows subsequent additions.
- 1.2.3 All those nominated including those nominated as substitute fielders, must be eligible to play for that particular team and by such nomination the nominees shall warrant that they are so eligible.
- 1.2.4 In addition, by their nomination, the nominees shall be deemed to have agreed to abide by all the applicable ICC Regulations pertaining to international cricket and in particular, the Clothing and Equipment Regulations, the Code of Conduct for Players and Player Support Personnel (hereafter referred to as the ICC Code of Conduct), the Anti-Racism Code for Players and Player Support Personnel, the Anti-Doping Code and the Anti-Corruption Code.

1.3 Law 1.3 – Captain

The following shall apply in addition to Law 1.3 (a):

The deputy must be one of the nominated members of the playing eleven.

Each Member Board must nominate its 'ODI Team Captain' to the ICC when appointed.

If the 'ODI Team Captain' is not participating in a series, the relevant Home Board must nominate a replacement 'ODI Team Captain' for the series. The Home Board shall advise the series Match Referee.

If the 'ODI Team Captain' plays in a match without being the nominated captain for that match, he will be deemed to be the captain should any penalties be applied for over rate breaches under the Code of Conduct.

2 LAW 2 - SUBSTITUTES AND RUNNERS, BATSMAN OR FIELDER LEAVING THE FIELD, BATSMAN RETIRING, BATSMAN COMMENCING INNINGS

Law 2 shall apply subject to the following:

2.1 Law 2.1 Substitutes and Runners

Law 2.1 (a) (ii), 2.7 and 2.8 shall not apply. A runner for a batsman when batting is not permitted.

Law 2.1 (b) shall be amended as follows:

The umpires shall have discretion to allow, for other wholly acceptable reasons, a substitute fielder to act for a nominated player, at the start of the match, or at any subsequent time.

2.2 Law 2.5 - Fielder absent or leaving the field

Law 2.5 shall be replaced by the following:

If a fielder fails to take the field with his side at the start of the match or at any later time, or leaves the field during a session of play, the umpire shall be informed of the reason for his absence, and he shall not thereafter come on to the field during a session of play without the consent of the umpire. (See Law 2.6 as modified). The umpire shall give such consent as soon as practicable.

If the player is absent from the field for longer than 8 minutes:

2.2.1 the player shall not be permitted to bowl in that innings after his return until he has been on the field for at least that length of playing time for which he was absent.

2.2.2 the player shall not be permitted to bat unless or until, in the aggregate, he has returned to the field and/or his side's innings has been in progress for at least that length of playing time for which he has been absent or, if earlier, when his side has lost five wickets.

The restriction in clauses 2.2.1 and 2.2.2 above shall not apply if the player has suffered an external blow (as opposed to an internal injury such as a pulled muscle) whilst participating earlier in the match and consequently been forced to leave the field. Nor shall it apply if the player has been absent for very exceptional and wholly acceptable reasons (other than injury or illness).

In the event of a batsman or a fieldsman already being off the field at the commencement of an interruption in play through ground, weather or light conditions or for other exceptional circumstances, he shall be allowed to count any such stoppage time as playing time, provided that he personally informs the umpires when he is fit enough to take the field had play been in progress. Similarly, if at the commencement of an interruption in play through ground, weather or light conditions or for other exceptional circumstances, a player is on the field but still has some unexpired penalty time remaining from a previous absence, he shall automatically be allowed to count any such stoppage time as playing time.

2.2.3 Substitute fielders shall only be permitted in cases of injury, illness or other wholly acceptable reasons. 'Wholly acceptable reasons' should be limited to extreme circumstances and should not include what is commonly referred to as a 'comfort break'.

Note: Squad members of the fielding team who are not playing in the match and who are not acting as substitute fielders shall be required to wear a team training bib whilst on the playing area (including the area between the boundary and the perimeter fencing).

3 LAW 3 - THE UMPIRES**3.1 Law 3.1 - Appointment and attendance**

Law 3.1 shall be replaced by the following:

The following rules for the selection and appointment of ODI umpires shall be followed as far as it is practicable to do so:

- 3.1.1 The umpires shall control the game as required by the Laws (as read with these playing conditions), with absolute impartiality and shall be present at the ground at least two hours before the scheduled start of play.
- 3.1.2 ICC shall establish an 'Elite Panel' of umpires who shall be contracted to the ICC.
- 3.1.3 Each Full Member shall nominate from its panel of first class umpires two umpires to an 'International Panel' and one umpire to a 'TV Panel'. (A third umpire may be nominated to the 'International Panel' with the written consent of the ICC).
- 3.1.4 ICC will appoint one umpire to stand in each ODI. Such umpires shall not be from the same country as the participating teams and shall be selected from the 'Elite Panel' or the 'International Panel'.
- 3.1.5 The Home Board shall appoint one umpire to stand in each ODI. Such umpire shall be selected from its umpires on the 'International Panel'.
- 3.1.6 In ODI matches where the DRS is used (see clause 3.2 below), ICC will appoint a third umpire who shall act as the emergency umpire and officiate in regard to the DRS. Such third umpire shall not be from the same country as the participating teams and shall be appointed from the 'Elite Panel' or the 'International Panel'.
- 3.1.7 In all other ODI matches, the third umpire will be appointed by the Home Board and he shall act as the emergency umpire and officiate in regard to TV replays. Such appointment must be made from the 'International Panel' or the 'TV Panel'.
- 3.1.8 The Home Board shall also appoint a fourth umpire for each ODI from its panel of first class umpires. The fourth umpire shall act as the emergency third umpire. In 'DRS' ODI matches the fourth umpire shall be appointed from the 'International Panel' or the 'TV Panel'.
- 3.1.9 In ODI matches involving Associate Members umpires from the ICC Associate and Affiliate Umpires Panel may be appointed.
- 3.1.10 As long as possible before each ODI Match, ICC will advise the Home Board of the name of its appointee(s) and the Home Board will advise the Manager of the visiting team of all umpires' names.
- 3.1.11 ICC shall appoint the match referee for all matches (ICC Match Referee).
- 3.1.12 The ICC Match Referee shall not be from the same country as the participating teams.
- 3.1.13 Neither team will have a right of objection to an umpire's or match referee's appointment.

3.2 Third Umpire / TV Replay System (DRS)

In matches where the DRS is used, the playing conditions set out in Appendix 7 shall apply.

In matches where the DRS is not used, including ODIs not between Full Member countries, the playing conditions set out in Appendix 9 shall apply.

3.3 Law 3.2 - Change of umpire

Law 3.2 shall be replaced by the following:

An umpire shall not be changed during the match, other than in exceptional circumstances, unless he is injured or ill.

3.4 Law 3.4 - To inform captains and scorers

The following shall apply in addition to Law 3.4 (i):

The Home Board may provide for the ringing of a bell, which shall be rung 5 minutes before the termination of an interval, when the umpires shall go to the wickets. The Home Board shall inform the ICC Match Referee and the Manager of the visiting team at the start of the tour that this practice is to be adopted.

3.5 Law 3.8 - Fitness for play and Law 3.9 - Suspension of play in dangerous or unreasonable conditions

3.5.1 The safety of all persons within the ground is of paramount importance to the ICC. In the event that any threatening circumstance, whether actual or perceived, comes to the attention of any umpire (including for example weather, pitch invasions, act of God, etc. See also clauses 3.5.4 and 3.5.5 below), then the players and officials should immediately be asked to leave the field of play in a safe and orderly manner and to relocate to a secure and safe area (depending on each particular threat) pending the satisfactory passing or resolution of such threat or risk to the reasonable satisfaction of the umpires, ICC Match Referee, the head of the relevant ground authority, the head of ground security and/or the police as the circumstances may require.

Laws 3.8 & 3.9 shall be replaced by:

- 3.5.2 The umpires shall be the final judges of the fitness of the ground, weather and light for play. See clause 3.5.3 below and Law 7.2 (Fitness of the pitch for play).
- 3.5.3 Suspension of play for adverse conditions of ground, weather or light
- All references to ground include the pitch. See Law 7.1 (Area of pitch).
 - If at any time the umpires together agree that the conditions of ground, weather or light are so bad that there is obvious and foreseeable risk to the safety of any player or umpire, so that it would be unreasonable or dangerous for play to take place, then they shall immediately suspend play, or not allow play to commence or to restart. The decision as to whether conditions are so bad as to warrant such action is one for the umpires alone to make.

The fact that the grass and the ball are wet and slippery does not warrant the ground conditions being regarded as unreasonable or dangerous. If the umpires consider the ground is so wet or slippery as to deprive the bowler of a reasonable foothold, the fielders of the power of free movement, or the batsmen of the ability to play their strokes or to run between the wickets, then these conditions shall be regarded as so bad that it would be unreasonable for play to take place.

The umpires shall disregard any shadow on the pitch from the stadium or from any permanent object on the ground.

- c) When there is a suspension of play it is the responsibility of the umpires to monitor the conditions. They shall make inspections as often as appropriate. Immediately the umpires together agree that conditions are suitable for play they shall call upon the players to resume the game.
 - d) If play is in progress up to the start of an agreed interval then it will resume after the interval unless the umpires together agree that the conditions of ground, weather or light are so bad that there is obvious and foreseeable risk to the safety of any player or umpire, so that it would be unreasonable or dangerous for play to take place.
- 3.5.4 Play may be suspended due to safety and security concerns by the umpires on the advice of the ICC Match Referee, the head of the relevant ground authority, the head of ground security or the police.
- 3.5.5 Where play is suspended under Clause 3.5.4 above the decision to abandon or resume play shall be the responsibility of the ICC Match Referee who shall act only after consultation with the head of ground security and the police.

3.6 Light Meters

- 3.6.1 It is the responsibility of the ICC to supply light meters to the match officials to be used in accordance with these playing conditions.
- 3.6.2 All light meters shall be uniformly calibrated.
- 3.6.3 The umpires shall be entitled to use light meter readings as a guideline for determining whether the light is fit for play in accordance with the criteria set out in clause 3.5.3 (b) above.
- 3.6.4 Light meter readings may accordingly be used by the umpires:
- a) To determine whether there has been at any stage a deterioration or improvement in the light.
 - b) As benchmarks for the remainder of a stoppage, match and/or series/event.

3.7 Use of artificial lights

If in the opinion of the umpires, natural light is deteriorating to an unfit level, they shall authorize the ground authorities to use the available artificial lighting so that the match can continue in acceptable conditions.

In the event of power failure or lights malfunction, the provisions relating to the delay or interruption of play due to bad weather or light shall apply.

3.8 Day Night matches

- 3.8.1 Pads and players' and umpires' clothing shall be coloured.
- 3.8.2 Sight screens will be black.

3.9 Advertising on grounds, perimeter boards and sightscreens

- 3.9.1 Advertising on grounds

The logos on outfielders are to be positioned as follows:

- a) Behind the stumps – a minimum of 25.15 yards (23 meters) from the stumps.
- b) Midwicket/cover area – no advertising to be positioned within the 30 yard (27.50 meters) circle.

Note: Advertising closer to the stumps as set out above which is required to meet 3D requirements for broadcasters may be permitted, subject to prior ICC approval having been obtained.

3.9.2 Perimeter Boards

- a) Advertising on perimeter boards placed in front of the sightscreens is permitted save that the predominant colour of such advertising shall be of a contrasting colour to that of the ball.
- b) Advertising on perimeter boards behind the stumps at both ends shall not contain moving, flashing or flickering images and operators should ensure that the images are only changed or moved at a time that will not be distracting to the players or the umpires.
- c) In addition, the brightness of any electronic images shall be set at a level so that it is not a distraction to the players or umpires.

3.9.3 Sightscreens

- a) Sightscreens shall be provided at both ends of all grounds.
- b) Advertising shall be permitted on the sightscreen behind the striker, providing it is removed for the subsequent over from that end.
- c) Such advertising shall not contain flashing or flickering images and particular care should be taken by the operators that the advertising is not changed at a time which is distracting to the umpire.

4 LAW 4 - THE SCORERS

Law 4 shall apply.

5 LAW 5 - THE BALL

5.1 Law 5.2 - Approval and control of balls

Law 5.2 shall be replaced by the following:

- 5.1.1 The Home Board shall provide cricket balls of an approved standard for ODI cricket and spare used balls for changing during a match which shall also be of the same brand. Note: The Home Board shall be required to advise the Visiting Boards of the brand of ball to be used in the match(es) at least 30 days prior to the start of the match(es).

The fielding captain or his nominee may select the balls with which he wishes to bowl from the supply provided by the Home Board. The fourth umpire shall take a box containing at least 6 new balls to the dressing room and supervise the selection of the balls.

The umpires shall retain possession of the match ball(s) throughout the duration of the match when play is not actually taking place. During play umpires shall periodically and irregularly inspect the condition of the balls and shall retain possession of them at the fall of a wicket, a drinks interval, or any other disruption in play. Where day/night matches are scheduled in a series, white balls will be used in all matches (including day matches).

- 5.1.2 Each fielding team shall have two new balls for its innings, to be used in alternate overs, i.e. one from each end.
- 5.1.3 In a match reduced to 25 overs or less per side before the first innings commences, each team shall have only one new ball for its Innings.

5.2 Law 5.4 - New ball in match of more than one day's duration

Law 5.4 shall not apply.

5.3 Law 5.5 - Ball lost or becoming unfit for play

Law 5.5 shall be replaced by the following:

- 5.3.1 In the event of a ball during play being lost or in the opinion of the umpires, being unfit for play through normal use, the umpires shall allow it to be replaced by one that in their opinion has had a similar amount of wear.
- 5.3.2 In the event of the ball becoming wet and soggy as a result of play continuing in inclement weather or it being affected by dew, and in the opinion of the umpires being unfit for play, the ball may be replaced for a ball that has similar amount of wear, even though it has not gone out of shape.
- 5.3.3 If the ball is to be replaced, the umpire shall inform the batsmen and the fielding captain. Either batsman or bowler may raise the matter with the umpires and the umpires' decision as to a replacement or otherwise will be final.

5.4 Law 5.6 - Specifications

Law 5.6 shall not apply.

6 LAW 6 - THE BAT

The following shall apply in addition to Law 6:

Only Type A bats shall be used in One Day International matches.

7 LAW 7 - THE PITCH**7.1 Law 7.3 - Selection and preparation**

The following will apply in addition to Law 7.3:

- 7.1.1 The ground staff shall ensure that during the period prior to the start of play and during intervals, the pitch area shall be roped off so as to prevent unauthorised access. (The pitch area shall include an area at least 2 metres beyond the rectangle made by the crease markings at both ends of the pitch).
- 7.1.2 The fourth umpire shall ensure that, prior to the start of play and during any intervals, only authorised ground staff, the ICC match officials, players, team coaches and authorised television personnel shall be allowed access to the pitch area. Such access shall be subject to the following limitations:
 - a) Only captains and team coaches may walk on the actual playing surface of the pitch area (outside of the crease markings).
 - b) Access to the pitch area by television personnel shall be restricted to one camera crew (including one or two television commentators) of the official licensed television broadcaster(s) (but not news crews).
 - c) No spiked footwear shall be permitted.
 - d) No one shall be permitted to bounce a ball on the pitch, strike it with a bat or cause damage to the pitch in any other way.
 - e) Access shall not interfere with pitch preparation.

7.1.3 In the event of any dispute, the ICC Match Referee will rule and his ruling will be final.

7.2 Law 7.4 - Changing the pitch

Law 7.4 shall be replaced by the following:

7.2.1 In the event of a pitch being considered too dangerous for play to continue in the estimation of the on-field umpires, they shall stop play and immediately advise the ICC Match Referee.

7.2.2 The on-field umpires and ICC Match Referee shall consult with both captains.

7.2.3 If the captains agree to continue, play shall resume.

7.2.4 If the decision is not to resume play, the on-field umpires together with the ICC Match Referee shall consider whether the existing pitch can be repaired and the match resumed from the point it was stopped. In considering whether to authorise such repairs, the ICC Match Referee must consider whether this would place either side at an unfair advantage, given the play that had already taken place on the dangerous pitch.

7.2.5 If the decision is that the existing pitch cannot be repaired, then the match is to be abandoned with the following consequences:

- a) In the event of the required number of overs to constitute a match having been completed at the time the match is abandoned, the result shall be determined according to the provisions of clause 21.7.2.
- b) In the event of the required number of overs to constitute a match not having been completed, the match will be abandoned as a no result.

7.2.6 If the match is abandoned as a no result, the ICC Match Referee shall consult with the Home Board with the objective of finding a way for a new match to be commenced and completed on the same date (including any reserve day) and venue.

7.2.7 Such a match may be played either on the repaired pitch or on another pitch, subject to the ICC Match Referee and the relevant ground authority both being satisfied that the new pitch will be of the required ODI standard. The playing time lost between the scheduled start time of the original match and the actual start time of the new match will be covered by the provisions of clauses 12 and 16 below.

7.2.8 If it is not possible to play a new match on the scheduled day of the match (including any reserve day), the relevant officials from the participating Boards shall agree on whether the match can be replayed within the existing tour schedule.

7.2.9 Throughout the above decision making processes, the ICC Match Referee shall keep informed both captains and the head of the ground authority. The head of the ground authority shall ensure that suitable and prompt public announcements are made.

7.3 Law 7.5 - Non-turf pitches

Law 7.5 shall not apply.

All matches shall be played on natural turf pitches. The use of PVA and other adhesives in the preparation of pitches is not permitted.

8 LAW 8 - THE WICKETS**8.1 Law 8.2 - Size of stumps**

The following shall apply in addition to Law 8.2:

For televised matches the Home Board may provide a slightly larger cylindrical stump to accommodate the stump camera. When the larger stump is used, all three stumps must be exactly the same size.

8.2 Zing Wickets

The use of Zing wickets is permitted.

Refer also to Appendix 7 clause 3.7 a) and Appendix 9 clause 2.5.

9 LAW 9 - THE BOWLING, POPPING AND RETURN CREASES**9.1 Law 9.3 - The Popping Crease**

Law 9.3 shall apply, except that the reference to 'a minimum of 6 ft' shall be replaced by 'a minimum of 15 yards (13.71 metres)'.

9.2 Additional Crease Markings

The following shall apply in addition to Law 9:

As a guideline to the umpires for the calling of wides on the offside the crease markings detailed in Appendix 4 shall be marked in white at each end of the pitch.

10 LAW 10 - PREPARATION AND MAINTENANCE OF THE PLAYING AREA**10.1 Law 10.1 - Rolling**

The following shall apply in addition to Law 10.1:

- 10.1.1 Prior to tossing for choice of innings the artificial drying of the pitch and outfield shall be at the discretion of the ground curator. Thereafter and throughout the match the drying of the outfield may be undertaken at any time by the ground curator, but the drying of the affected area of the pitch shall be carried out only on the instructions and under the supervision of the umpires. The umpires shall be empowered to have the pitch dried without reference to the captains at any time they are of the opinion that it is unfit for play.
- 10.1.2 The umpires may instruct the ground curator to use any available equipment, including any roller for the purpose of drying the pitch and making it fit for play.
- 10.1.3 An absorbent roller may be used to remove water from the covers including the cover on the match pitch.

10.2 Law 10.6 - Maintenance of footholes

The following shall apply in addition to Law 10.6:

The umpires shall see that wherever possible and whenever it is considered necessary, action is taken during all intervals in play to do whatever is practicable to improve the bowler's foot holes.

10.3 Protection and preparation of adjacent pitches during matches

The protection (by way of an appropriate cover) and preparation of pitches which are adjacent to the match pitch will be permitted during the match subject to the following:

- 10.3.1 Such measures will only be possible if requested by the ground curator and approved by the umpires before the start of the match.

- 10.3.2 Approval should only be granted where such measures are unavoidable and will not compromise the safety of the players or their ability to execute their actions with complete freedom.
- 10.3.3 The preparation work shall be carried out under the supervision of the fourth umpire.
- 10.3.4 Any necessary watering shall be carried out only to the extent necessary for such preparations and shall not be permitted in circumstances which may in any way affect the match pitch.
- 10.3.5 The consent of the captains is not required but the umpires shall advise both captains and the ICC Match Referee before the start of the match on what has been agreed.

11 LAW 11 - COVERING THE PITCH

11.1 Law 11.1 - Before the match

The following shall apply in addition to Law 11.1:

The pitch shall be entirely protected against rain up to commencement of play.

11.2 Law 11.2 - During the match

Law 11.2 shall be replaced by the following:

The pitch shall be entirely protected against rain up to the commencement of play and for the duration of the period of the match.

The covers must totally protect the pitch and also the pitch surroundings, a minimum 5 metres either side of the pitch and any worn or soft areas in the outfield.

11.3 Law 11.3 - Covering bowlers' run ups

Law 11.3 shall be replaced by the following:

The bowler's run-ups shall be covered in inclement weather, in order to keep them dry, to a distance of at least 10 x 10 metres.

11.4 Law 11.4 - Removal of covers

Law 11.4 shall be replaced by the following:

All covers (including "hessian" or "scrim" covers used to protect the pitch against the sun) shall be removed not later than 2½ hours before the scheduled start of play provided it is not raining at the time, but the pitch will be covered again if rain falls prior to the commencement of play.

Attention is drawn to clauses 3.5 and 10.3 above.

12 LAW 12 - INNINGS

Law 12 shall apply subject to the following (see also clauses 15 and 16 below):

12.1 Law 12.1 - Number of innings

Law 12.1 shall be replaced by the following:

All matches will consist of one innings per side, each innings being limited to a maximum of 50 overs. All matches shall be of one day's scheduled duration provided that participating countries in a series may agree to provide for a reserve day on which an incomplete match may be replayed or continued from the scheduled day.

If the match is to be continued on the reserve day, the participating countries may agree either that:

- 12.1.1 Any revision of overs only occurs on the final scheduled day of the match; or
- 12.1.2 Every effort is made to complete the match on the scheduled day with any necessary reduction in overs taking place and only if the minimum number of overs necessary to constitute a match cannot be bowled on the scheduled day will the match be completed on the reserve day.
- 12.1.3 If the match has started on the scheduled day and overs are subsequently reduced following an interruption, but no further play is possible, the match will resume on the reserve day at the point where the last ball was played. Refer Appendix 10.

12.2 Law 12.2 - Alternate innings

Law 12.2 shall not apply.

12.3 Law 12.3 - Completed innings

Laws 12.3 (c), (d) and (e) (iii) shall not apply.

12.4 Length of Innings

12.4.1 Uninterrupted Matches.

- a) Each team shall bat for 50 overs unless all out earlier.
- b) If the team fielding first fails to bowl the required number of overs by the scheduled time for cessation of the first innings, play shall continue until the required number of overs has been bowled. The interval shall be reduced to enable the second innings to commence at the scheduled time, subject to there being a minimum interval of 30 minutes. The team batting second shall receive its full quota of 50 overs irrespective of the number of overs it bowled in the scheduled time for the cessation of the first innings.
- c) If the team batting first is dismissed in less than 50 overs, the team batting second shall be entitled to bat for 50 overs.
- d) If the team fielding second fails to bowl 50 overs by the scheduled cessation time, the hours of play shall be extended until the required number of overs has been bowled or a result is achieved.
- e) Penalties shall apply for slow over rates (refer ICC Code of Conduct).

12.4.2 Delayed or Interrupted Matches

- a) Delay or Interruption to the Innings of the Team Batting First (see Appendix 2)
 - i) When playing time has been lost the revised number of overs to be bowled in the match shall be based on a rate of 14.28 overs per hour, which is inclusive of the provision of drinks intervals, in the total remaining time available for play.
 - ii) The revision of the number of overs should ensure, whenever possible, that both teams have the opportunity of batting for the same number of overs. The team batting second shall not bat for a greater number of overs than the first team unless the latter completed its innings in less than its allocated overs. To constitute a match, a minimum of 20 overs have to be bowled to the side batting second, subject to a result not being achieved earlier.

- iii) As soon as the total minutes of playing time remaining is less than the completed overs faced by Team 1 multiplied by 4.2, then the first innings is terminated and the provisions of 12.4.2 (b) below take effect.
 - iv) A fixed time will be specified for the commencement of the interval, and also the close of play for the match, by applying a rate of 14.28 overs per hour. When calculating the length of playing time available for the match, or the length of either innings, the timing and duration of all relative delays, extensions in playing hours, interruptions in play, and intervals, excluding those for drinks, will be taken into consideration. This calculation must not cause the match to finish earlier than the original or rescheduled time for cessation of play on the final scheduled day for play. If required the original time shall be extended to allow for one extra over for each team.
 - v) If the team fielding first fails to bowl the revised number of overs by the specified time, play shall continue until the required number of overs have been bowled or the innings is completed.
 - vi) Penalties shall apply for slow over rates (refer to ICC Code of Conduct).
- b) Delay or Interruption to the innings of the Team Batting Second (see Appendix 3)
- i) When playing time has been lost and, as a result, it is not possible for the team batting second to have the opportunity of receiving its allocated, or revised allocation of overs in the playing time available, the number of overs shall be reduced at a rate of 14.28 overs per hour, which is inclusive of the provision of drinks intervals, in respect of the lost playing time. Should the calculations result in a fraction of an over the fraction shall be ignored.
 - ii) In addition, should the innings of the team batting first have been completed prior to the scheduled, or re-scheduled time for the commencement of the interval, then any calculation relating to the revision of overs shall not be effective until an amount of time equivalent to that by which the second innings started early has elapsed.
 - iii) To constitute a match, a minimum of 20 overs have to be bowled to the team batting second subject to a result not being achieved earlier.
 - iv) The team batting second shall not bat for a greater number of overs than the first team unless the latter completed its innings in less than its allocated overs.
 - v) A fixed time will be specified for the close of play by applying a rate of 14.28 overs per hour. With the exception of drinks intervals, the timing and duration of all relative delays, extensions in playing hours and interruptions in play, will be taken into consideration in specifying this time.
 - vi) If the team fielding second fails to bowl the revised overs by the scheduled or re-scheduled close of play, the hours of play shall be extended until the overs have been bowled or a result achieved.
 - vii) Penalties shall apply for slow over rates (refer ICC Code of Conduct).

12.5 Extra Time

The participating countries may agree to provide for extra time where the start of play is delayed or play is suspended.

12.6 Number of Overs per Bowler

No bowler shall bowl more than 10 overs in an innings.

In a delayed or interrupted match where the overs are reduced for both teams or for the team bowling second, no bowler may bowl more than one-fifth of the total overs allowed.

Where the total overs is not divisible by 5, one additional over shall be allowed to the maximum number per bowler necessary to make up the balance.

In the event of a bowler breaking down and being unable to complete an over, the remaining balls will be allowed by another bowler. Such part of an over will count as a full over only in so far as each bowler's limit is concerned.

The scoreboard shall show the total number of overs bowled and the number of overs bowled by each bowler.

12.7 Law 12.4 – The toss

Law 12.4 shall be replaced by the following:

The captains shall toss for the choice of innings, on the field of play and in the presence of the ICC Match Referee, who shall supervise the toss. The toss shall take place not earlier than 30 minutes, nor later than 15 minutes before the scheduled or any re-scheduled time for the match to start. Note, however, the provisions of Law 1.3 (Captain).

Note: Law 12.5 requiring the captain of the side winning the toss to notify the opposing captain as soon as the toss is completed of his decision to bat or to field first shall apply.

13 LAW 13 - THE FOLLOW-ON

Law 13 shall not apply.

14 LAW 14 - DECLARATION AND FORFEITURE

Law 14 shall not apply.

15 LAW 15 - INTERVALS**15.1 Law 15.5 - Changing agreed times for intervals - Interval between Innings**

If the innings of the team batting first is completed prior to the scheduled time for the interval, the interval shall take place immediately and the innings of the team batting second will commence correspondingly earlier providing that this does not lead to an interval occurring more than 30 minutes prior to the scheduled interval.

If the innings of the team batting first is completed more than 30 minutes prior to the scheduled interval a 10 minute break will occur and the team batting second will commence its innings and the interval will occur as scheduled.

Where the innings of the side batting first is delayed or interrupted, the length of the interval will be reduced as follows:

- i) If up to 15 minutes of actual playing time is lost (total playing time lost less any extra time provided), then the interval will be reduced by the amount of actual playing time lost.
- ii) If more than 15 minutes of actual playing time is lost (total playing time lost less any extra time provided), then the interval will be reduced to 30 minutes (subject to (iii) below).
- iii) Note: The prescribed interval timings above may be reduced further by the ICC Match Referee taking into account the intention of not having a prolonged interval after a lengthy interruption close to the conclusion of the innings of the team batting first. However, the minimum interval shall not be less than ten minutes.

15.2 Law 15.9 - Intervals for drinks

Two drinks breaks per session shall be permitted, each 1 hour 10 minutes apart. The provisions of Law 15.9 shall be strictly observed except that under conditions of extreme heat the umpires may permit extra intervals for drinks.

An individual player may be given a drink either on the boundary edge or at the fall of a wicket, on the field, provided that no playing time is wasted. No other drinks shall be taken onto the field without the permission of the umpires. Any player taking drinks onto the field shall be dressed in proper cricket attire (subject to the wearing of bibs – refer to the note in clause 2.2.3).

16 LAW 16 - START OF PLAY; CESSATION OF PLAY

Law 16 shall apply subject to the following (see also clauses 15 and 12.4):

16.1 Start and Cessation Times

To be determined by the Home Board subject to there being 2 sessions of 3.5 hours each, separated by a 45 minute interval between innings.

Note: The playing hours of matches scheduled to take place at venues where dew is likely to be a factor should be determined so as to ensure that the effect of any dew is minimised.

16.2 Laws 16.6, 16.7 and 16.8 shall not apply.

16.3 Laws 16.9, 16.10, and 16.11 shall apply in so far as they are relevant to a one innings limited overs type match.

16.4 Minimum Over Rates

The minimum over rate to be achieved in ODI matches will be 14.28 overs per hour.

The actual over rate will be calculated at the end of the match by the umpires.

In calculating the actual over rate for the match, allowances will be given for the actual time lost as a result of any of the following:

- 16.4.1 treatment given to a player by an authorised medical personnel on the field of play;
- 16.4.2 a player being required to leave the field as a result of a serious injury;
- 16.4.3 all third umpire referrals and consultations;
- 16.4.4 time wasting by the batting side; and

16.4.5 all other circumstances that are beyond the control of the fielding side.

In the event of any time allowances being granted to the fielding team under 16.4.4 above (time wasting by batting team), then such time shall be deducted from the allowances granted to such batting team in the determination of its over rate.

If a side is bowled out within the time determined for that innings pursuant to these playing conditions (taking into account all of the time allowances set out above), the fielding side shall be deemed to have complied with the required minimum over rate.

17 LAW 17 - PRACTICE ON THE FIELD

Law 17 shall apply subject to the following:

17.1 Law 17.1 - Practice on the pitch or the rest of the square

Law 17.1 shall apply subject to the following:

- a) The use of the square for practice on any day of any match will be restricted to any netted practice area or bowling strips specifically prepared on the edge of the square for that purpose.
- b) Bowling practice on the bowling strips referred to in (a) above shall also be permitted during the interval (and change of innings if not the interval) unless the umpires consider that, in the prevailing conditions of ground and weather, it will be detrimental to the surface of the square.

17.2 Law 17.3 - Practice on the outfield between the call of play and the call of time

Law 17.3 shall apply save that Law 17.3 (c) shall be replaced with the following:

- c) There shall be no bowling or batting practice on the outfield. Bowling a ball, using a short run up to a player in the outfield is not to be regarded as bowling practice but shall be subject to the law.

18 LAW 18 - SCORING RUNS

Law 18 shall apply.

19 LAW 19 - BOUNDARIES

Law 19 shall apply subject to the following:

19.1 Law 19.1 - The boundaries of the field of play

The following shall apply in addition to Law 19.1:

The playing area shall be a minimum of 150 yards (137.16 metres) from boundary to boundary square of the pitch, with the shorter of the two square boundaries being a minimum 65 yards (59.43 metres). The straight boundary at both ends of the pitch shall be a minimum of 70 yards (64.00 metres). Distances shall be measured from the centre of the pitch to be used.

In all cases the aim shall be to provide the largest playing area, subject to no boundary exceeding 90 yards (82.29 meters) from the centre of the pitch to be used.

Any ground which has been approved to host international cricket prior to 1st October 2007 or which is currently under construction as of this date which is unable to conform to these new minimum dimensions shall be exempt. In such cases the regulations in force immediately prior to the adoption of these regulations shall apply.

19.2 Law 19.2 - Defining the boundary - boundary marking

The following shall apply in addition to Law 19.2:

All boundaries must be designated by a rope or similar object of a minimum standard as authorised by the ICC from time to time. Where appropriate the rope should be a required minimum distance (3 yards [2.74 metres] minimum) inside the perimeter fencing or advertising signs. For grounds with a large playing area, the maximum length of boundary should be used before applying the minimum 3 yards (2.74 meters) between the boundary and the fence.

19.3 Law 19.3 - Scoring a boundary

The following shall apply in addition to Law 19.3:

If an unauthorized person enters the playing arena and handles the ball, the umpire at the bowler's end shall be the sole judge of whether the boundary allowance should be scored or the ball be treated as still in play or called dead ball if a batsman is liable to be out as a result of the unauthorized person handling the ball. See also Law 19.1 (c).

20 LAW 20 - LOST BALL

Law 20 shall apply.

21 LAW 21 - THE RESULT

Law 21 shall apply subject to the following:

21.1 Law 21.1 - A win - two innings match

Law 21.1 shall not apply.

21.2 Law 21.2 - A win - one innings match

Law 21.2 shall apply in addition to the following:

21.2.1 Save for circumstances where a match is awarded to a team as a consequence of the opposing team's refusal to play (Law 21.3), a result can be achieved only if both teams have had the opportunity of batting for at least 20 overs, unless one team has been all out in less than 20 overs or unless the team batting second scores enough runs to win in less than 20 overs.

21.2.2 Save for circumstances where a match is awarded to a team as a consequence of the opposing team's refusal to play (Law 21.3), all matches in which both teams have not had an opportunity of batting for a minimum of 20 overs, shall be declared no result.

21.3 Law 21.3 – Umpire (ICC Match Referee) awarding a match

Law 21.3 shall be replaced by the following:

- a) A match shall be lost by a side which either
 - i) concedes defeat or
 - ii) in the opinion of the ICC Match Referee refuses to play and the ICC Match Referee shall award the match to the other side.
- b) If an umpire considers that an action by any player or players might constitute a refusal by either side to play then the umpires together shall inform the ICC Match Referee of this fact. The ICC Match Referee shall together with the umpires ascertain the cause of the action. If the ICC Match Referee, after due consultation with the umpires,

then decides that this action does constitute a refusal to play by one side, he shall so inform the captain of that side. If the captain persists in the action the ICC Match Referee shall award the match in accordance with (a)(ii) above.*

- c) If action as in (b) above takes place after play has started and does not constitute a refusal to play the delay or interruption in play shall be dealt with in the same manner as provided for in clauses 12.4.2 and 15.1 above.

* N/B In addition to the consequences of any refusal to play prescribed under this clause, any such refusal, whether temporary or final, may result in disciplinary action being taken against the captain and team responsible under the Code of Conduct

21.4 Law 21.4 – Matches in which there is an agreement under Law 12.1 (b)

Law 21.4 shall not apply.

21.5 Law 21.5 (a) - A Tie

The following shall apply in addition to Law 21.5 (a):

If the scores are equal, the result shall be a tie and no account shall be taken of the number of wickets which have fallen.

21.6 Law 21.5 (b) - A Draw

Law 21.5 (b) shall not apply.

21.7 Prematurely Terminated Matches - Calculation of the Target Score

21.7.1 Interrupted Matches - Calculation of the Target Score

If, due to suspension of play after the start of the match, the number of overs in the innings of either team has to be revised to a lesser number than originally allotted (minimum of 20 overs), then a revised target score (to win) should be set for the number of overs which the team batting second will have the opportunity of facing. This revised target is to be calculated using the current Duckworth/Lewis method. The target set will always be a whole number and one run less will constitute a Tie. (Refer Duckworth/Lewis Regulations)

21.7.2 Prematurely Terminated Matches

If the innings of the side batting second is suspended (with at least 20 overs bowled) and it is not possible for the match to be resumed, the match will be decided by comparison with the D/L 'Par Score' determined at the instant of the suspension by the Duckworth/Lewis method (refer Duckworth/Lewis Regulations). If the score is equal to the par score, the match is a Tie. Otherwise the result is a victory, or defeat, by the margin of runs by which the score exceeds, or falls short of, the Par Score.

21.8 Law 21.8 - Correctness of result

Any query on the result of the match as defined in Laws 21.2, 21.3, 21.5, 21.8 and 21.10 (as modified by these regulations) shall be resolved as soon as possible and a final decision made by the umpires at close of play.

21.9 Points

21.9.1 Preliminary Matches

In a competition with three or four Members with ODI status and with a final match or series, the home Board will institute a points system as follows:

Win, with bonus point	5
Win, without bonus point	4
Tie or No Result	2
Loss	0

In the event of teams finishing on equal points, the right to play in the final match or series will be determined as follows:

- The team with the most number of wins
- If still equal, the team with the most number of wins over the other team(s) who are equal on points and have the same number of wins
- If still equal, the team with the highest number of bonus points
- If still equal, the team with the highest net run rate

In a match declared as no result, run rate is not applicable.

21.9.2 Net Run Rate

A team's net run rate is calculated by deducting from the average runs per over scored by that team throughout the competition, the average runs per over scored against that team throughout the competition.

In the event of a team being all out in less than its full quota of overs, the calculation of its net run rate shall be based on the full quota of overs to which it would have been entitled and not on the number of overs in which the team was dismissed.

Only those matches where results are achieved will count for the purpose of net run rate calculations. Where a match is abandoned, but a result is achieved under Duckworth/Lewis, for net run rate purposes Team 1 will be accredited with Team 2's Par Score on abandonment off the same number of overs faced by Team 2. Where a match is concluded but with Duckworth/Lewis having been applied at an earlier point in the match, Team 1 will be accredited with 1 run less than the final Target Score for Team 2 off the total number of overs allocated to Team 2 to reach the target.

21.9.3 Bonus Points

The team that achieves a run rate of 1.25 times that of the opposition shall be awarded one bonus point. A team's run rate will be calculated by reference to the runs scored in an innings divided by the number of overs faced. Refer Appendix 6.

21.9.4 Final Match or Series

If no result is achieved in a final the match shall be declared drawn.

In the event of a drawn final, the prize money will be shared equally between the two competing teams.

22 LAW 22 - THE OVER

Law 22 shall apply subject to the following:

22.1 Law 22.5 - Umpire miscounting

The following shall apply in addition to Law 22.5:

Whenever possible the third umpire shall liaise with the scorers and if possible inform the on-field umpires if the over has been miscounted.

23 LAW 23 - DEAD BALL

Law 23 shall apply subject to the addition of the following to Law 23.4.

23.1 Law 23.4 – Umpire calling and signalling ‘Dead Ball’

In a match where cameras are being used on or over the field of play (e.g. Spydercam), should a ball that has been hit by the batsman make contact, while still in play, with the camera, its apparatus or its cable, either umpire shall call and signal ‘dead ball’. The ball shall not count as one of the over and no runs shall be scored. If the delivery was called a no ball it shall count and the no ball penalty applied, including if appropriate a free hit from the next delivery. No other runs (including penalty runs) apart from the no ball penalty shall be scored.

Should a ball thrown by a fielder make contact with a camera on or over the field of play, its apparatus or its cable, either umpire shall call and signal dead ball. Unless this was already a no-ball or wide, the ball shall count as one of the over. All runs scored to that point shall count, plus the run in progress if the batsmen have already crossed.

24 LAW 24 - NO BALL

Law 24 shall apply subject to the following:

24.1 Law 24.1 (b) - Mode of delivery

Law 24.1 (b) shall be replaced by the following:

The bowler may not deliver the ball underarm. If a bowler bowls a ball underarm the umpire shall call and signal no ball, and the ball is to be re-bowled overarm.

24.2 Free Hit after a foot-fault no ball

In addition to the above, the delivery following a no ball called for a foot fault (Law 24.5) shall be a free hit for whichever batsman is facing it. If the delivery for the free hit is not a legitimate delivery (any kind of no ball or a wide ball) then the next delivery will become a free hit for whichever batsman is facing it.

For any free hit, the striker can be dismissed only under the circumstances that apply for a no ball, even if the delivery for the free hit is called wide ball.

Field changes are not permitted for free hit deliveries unless there is a change of striker (the provisions of clause 41.2 shall apply).

The umpires will signal a free hit by (after the normal No Ball signal) extending one arm straight upwards and moving it in a circular motion.

24.3 Fair Delivery - the feet

Law 24.5 shall apply, subject to the final paragraph being replaced by the following:

If the bowler's end umpire is satisfied that any of these three conditions have not been met, he shall call and signal No ball.

25 LAW 25 - WIDE BALL

25.1 Law 25.1 - Judging a Wide

Law 25 shall apply with the following addition to Law 25.1:

Umpires are instructed to apply very strict and consistent interpretation in regard to this Law in order to prevent negative bowling wide of the wicket.

Any offside or legside delivery which in the opinion of the umpire does not give the batsman a reasonable opportunity to score shall be called a wide.

A penalty of one run for a wide shall be scored. This penalty shall stand in addition to any other runs which are scored or awarded. All runs, which are run or result from a wide ball, which is not a no ball, shall be scored wide balls.

26 LAW 26 - BYE AND LEG BYE

Law 26 shall apply.

27 LAW 27 - APPEALS

Law 27 shall apply.

28 LAW 28 - THE WICKET IS DOWN

Law 28 shall apply.

29 LAW 29 - BATSMAN OUT OF HIS GROUND

Law 29 shall apply.

30 LAW 30 - BOWLED

Law 30 shall apply.

31 LAW 31 - TIMED OUT

Law 31 shall apply.

Refer also to clause 42.9 (Law 42.10).

32 LAW 32 - CAUGHT

Law 32 shall apply.

33 LAW 33 - HANDLED THE BALL

Law 33 shall apply.

34 LAW 34 - HIT THE BALL TWICE

Law 34 shall apply.

35 LAW 35 - HIT WICKET

Law 35 shall apply.

36 LAW 36 - LEG BEFORE WICKET

Law 36 shall apply.

37 LAW 37 - OBSTRUCTING THE FIELD

Law 37 shall apply. For the avoidance of doubt, if an umpire feels that a batsman, in running between the wickets, has significantly changed his direction without probable cause and thereby obstructed a fielder's attempt to effect a run out, the batsman should, on appeal, be given out, obstructing the field. It shall not be relevant whether a run out would have occurred or not.

If the change of direction involves the batsman crossing the pitch, Law 42.14 shall also apply.

See also paragraph 2.4 of Appendix 7 and paragraph 5 of Appendix 9.

38 LAW 38 - RUN OUT

Law 38 shall apply.

39 LAW 39 - STUMPED

Law 39 shall apply.

40 LAW 40 - THE WICKET-KEEPER

Law 40 shall apply.

41 LAW 41 - THE FIELDER

Law 41 shall apply subject to the following:

41.1 Law 41.1 - Protective equipment

The following shall apply in addition to Law 41.1:

The exchanging of protective equipment between members of the fielding side on the field shall be permitted provided that the umpires do not consider that it constitutes a waste of playing time.

41.2 Restrictions on the placement of fieldsmen

- 41.2.1 At the instant of delivery, there may not be more than 5 fieldsmen on the leg side.
- 41.2.2 In addition to the restriction contained in clause 41.2.1 above, further fielding restrictions shall apply to certain overs in each innings. The nature of such fielding restrictions and the overs during which they shall apply (hereinafter referred to as the Powerplay Overs) are set out in the following paragraphs.
- 41.2.3 The following fielding restrictions shall apply:
 - a) Two semi-circles shall be drawn on the field of play. The semi-circles shall have as their centre the middle stump at either end of the pitch. The radius of each of the semi-circles shall be 30 yards (27.43 metres). The semi-circles shall be linked by two parallel straight lines drawn on the field. (Refer attached Appendix 5). The fielding restriction areas should be marked by continuous painted white lines or 'dots' at 5 yard (4.57 metres) intervals, each 'dot' to be covered by a white plastic or rubber (but not metal) disc measuring 7 inches (18 cm) in diameter.

During the first block of Powerplay Overs (as set out below), only two fieldsmen shall be permitted outside this fielding restriction area at the instant of delivery.

During the second block of Powerplay Overs only three fieldsmen shall be permitted outside this fielding restriction area at the instant of delivery.

- b) Two inner circles shall be drawn on the field of play. The circles shall have as their centres the centrepoint of the popping crease at either end of the pitch. The radius of each of the circles shall be 15 yards (13.72 metres). These fielding restriction areas should be marked by 'dots'. The segment of the circles reserved for the slip positions shall not be demarcated (refer attached Appendix 5).

During the first block of Powerplay Overs (in an uninterrupted innings, the first 10), there must be a minimum of two stationary fieldsmen within the applicable fielding restriction area measured from the striker's end at the instant of delivery. When a fast bowler is bowling the two stationary fieldsmen may be permitted to stand deeper than 15 yards (13.72 metres) (in the undemarcated area) provided only that they are standing in slip, leg slip or gully positions.

- 41.2.4 During the non Powerplay Overs, no more than four fieldsmen shall be permitted outside the fielding restriction area referred to in clause 41.2.3 (a) above.
- 41.2.5 Subject to the provisions of 41.2.6 below, the Powerplay Overs shall apply for 15 overs per innings to be taken as follows:
 - a) The first block of Powerplay Overs (block of 10 overs for an uninterrupted match) shall be at the commencement of the innings.
 - b) The second block of Powerplay Overs (block of 5 overs for an uninterrupted match) shall be taken at the discretion of either of the batsmen at the wicket. In an innings of scheduled duration of between 41 and 50 overs, it may not be completed later than the 40th over. (No equivalent restriction applies to innings of shorter scheduled duration.)
 - c) A batsman must nominate his team's Powerplay no later than the moment at which the umpire reaches the stumps at the bowler's end for the start of the next over.
 - d) Once a batsman has nominated a Powerplay, the decision cannot be reversed.
 - e) Should the batting side choose not to exercise their discretion, their Powerplay Overs will automatically commence at the latest available point in the innings (e.g. in a 50 over innings, this will begin at the start of the 36th over).

- 41.2.6 In circumstances when the number of overs of the batting team is reduced, the number of Powerplay Overs shall be reduced in accordance with the table below. For the sake of clarity, it should be noted that the table shall apply to both the 1st and 2nd innings of the match.

INNINGS DURATION	FIRST POWERPLAY	SECOND POWERPLAY	POWERPLAY TOTAL
20 - 21	4	2	6
22 - 24	5	2	7
25 - 28	5	3	8
29 - 31	6	3	9
32 - 34	7	3	10
35 - 38	7	4	11
39 - 41	8	4	12
42 - 44	9	4	13
45 - 48	9	5	14
49	10	5	15

- 41.2.7 Each block of Powerplay Overs must commence at the start of an over.
- 41.2.8 If play is interrupted not during the Powerplay overs, then on resumption, it is necessary to determine how any remaining Powerplay overs should be allocated. The total number of Powerplay overs for the innings is derived from the table in 41.2.6. Any Powerplay overs already taken prior to the interruption will be deemed to have been from the initial allocation followed by the batting side's allocation. The decision of the batting side of when to take any remaining Powerplay overs is made in the usual way.

Illustrations of 41.2.8:

A match starts as 50 overs, is interrupted after 12 overs and reduced to 43 overs. (The first 10 overs have been Powerplays (PP); the next two were not.) The new PP allocation is 9+4, so there are 3 overs left for the batting side. These must start no later than the 38th over in order to be completed by the 40th over.

- 41.2.9 If play is interrupted during the first Powerplay and on resumption the overs required to be bowled in that Powerplay have already been exceeded, then the second Powerplay will be assumed to have been taken immediately and will continue until it is completed.

Illustrations of 41.2.9

A 50 over innings is interrupted after 9.3 overs, and on resumption has been reduced to 43 overs. Powerplay overs are 9+4. 2nd Powerplay is in progress with 0.3 out of the 4 overs completed, i.e. it covers overs 10 to 13. The fielding restrictions relating to the second powerplay take immediate effect on resumption.

- 41.2.10 If following an interruption, on resumption the total number of Powerplay Overs for the innings has already been exceeded, then there will be no further Powerplay deliveries bowled in the innings. Note that this is the only circumstance under which the Powerplay status can be changed during an over.

Illustrations of 41.2.10

A 45 over innings is interrupted after 8.3 overs, and on resumption has been reduced to 28 overs. Powerplay overs are 5+3. All Powerplay overs have been completed. Non-Powerplay restrictions take effect immediately and do not need to wait until the end of the over.

- 41.2.11 If following an interruption while a Powerplay is not in progress, it is found on resumption that the recalculated number of Powerplay Overs remaining exceeds the number of overs to be bowled in the innings, then the Powerplays will commence at the start of the next over, with fewer than the scheduled number of Powerplay Overs being bowled in the innings.

Illustration of 41.2.11:

A 41 over innings in which only the 1st Powerplay has been taken is interrupted after 35.1 overs and reduced to 39 overs. Powerplay overs are still 8+4. Powerplays automatically resume for the start of the next over, but only 11 of the 12 scheduled Powerplay overs can be bowled in the innings.

- 41.2.12 At the commencement of the second block of Powerplay Overs, the umpire shall signal such commencement to the scorers by rotating his arm in a large circle.
- 41.2.13 The umpire shall also indicate to the fielding captain before any signal is made that the batting side has chosen its Powerplay.
- 41.2.14 A light or other indicator shall be displayed on the scoreboard whenever the Powerplay Overs are being bowled, along with the number of overs remaining in the current block of Powerplay Overs.
- 41.2.15 The public address system shall be used to keep the spectators informed.
- 41.2.16 In the event of an infringement of any of the above fielding restrictions, the square leg umpire shall call and signal 'No Ball'.

42 LAW 42 - FAIR AND UNFAIR PLAY

42.1 Law 42.3 - The Match Ball - changing its condition

Law 42.3 shall apply, subject to the following:

Law 42.3 (d) and (e) shall be replaced with the following:

If the umpires together agree that the deterioration of the ball is inconsistent with the use it has received, they shall consider that there has been a contravention of this Law. They shall then decide together whether they can identify the player(s) responsible for such conduct.

- 42.1.1 If it is possible to identify the player(s) responsible:
- Change the ball forthwith. The batsman at the wicket shall choose the replacement ball from a selection of six other balls of various degrees of usage (including a new ball) and of the same brand as the ball in use prior to the contravention.
Additionally the bowler's end umpire shall:
 - Award 5 penalty runs to the batting side.
 - Inform the captain of the fielding side of the reason for the action taken.
 - Inform the captain of the batting side as soon as practicable of what has occurred.

- e) Together with the other umpire report the incident to the ICC Match Referee who shall take action as is appropriate against the player(s) responsible for the conduct under the ICC Code of Conduct.
- 42.1.2 If it is not possible to identify the player(s) responsible:
- a) Change the ball forthwith. The umpires shall choose the replacement ball for one of similar wear and of the same brand as the ball in use prior to the contravention.
 - b) The bowler's end umpire shall issue the captain with a first and final warning, and
 - c) Advise him that should there be any further incident by that team during the remainder of the match or series, steps 42.1.1 a) to e) above will be adopted, with the captain deemed under e) to be the player responsible.

42.2 Law 42.4 - Deliberate attempt to distract striker

Law 42.4 shall apply subject to the following:

In addition, the umpires shall report the incident to the ICC Match Referee under the ICC Code of Conduct.

42.3 Law 42.5 - Deliberate distraction or obstruction of batsman

Law 42.5 shall apply subject to the following:

In addition, the umpire shall report the incident to the ICC Match Referee under the ICC Code of Conduct.

42.4 Law 42.6 - Dangerous and Unfair Bowling

42.4.1 Law 42.6 (a) - The Bowling of Fast Short Pitched Balls

Law 42.6 (a) shall be replaced by the following:

- a) A bowler shall be limited to two fast short-pitched deliveries per over.
- b) A fast short-pitched delivery is defined as a ball which passes or would have passed above the shoulder height of the striker standing upright at the popping crease.
- c) The umpire at the bowlers end shall advise the bowler and the batsman on strike when each fast short pitched delivery has been bowled.
- d) In addition, for the purpose of this regulation and subject to Clause 42.4.1 (f) below, a ball that passes above head height of the batsman, that prevents him from being able to hit it with his bat by means of a normal cricket stroke shall be called a wide.
- e) For the avoidance of doubt any fast short pitched delivery that is called a wide under this playing condition shall also count as one of the allowable short pitched deliveries in that over.
- f) In the event of a bowler bowling more than two fast short-pitched deliveries in an over as defined in Clause 42.4.1 (b) above, the umpire at the bowlers end shall call and signal no ball on each occasion. A differential signal shall be used to signify a fast short pitched delivery. The umpire shall call and signal 'no ball' and then tap the head with the other hand.

- g) If a bowler delivers a third fast short pitched ball in an over, the umpire, after the call of no ball and when the ball is dead, shall caution the bowler, inform the other umpire, the captain of the fielding side and the batsmen at the wicket of what has occurred. This caution shall apply throughout the innings.
- h) If there is a second instance of the bowler being no balled in the innings for bowling more than two fast short pitched deliveries in an over, the umpire shall advise the bowler that this is his final warning for the innings.
- i) Should there be any further instance by the same bowler in that innings, the umpire shall call and signal no ball and when the ball is dead direct the captain to take the bowler off forthwith.
If necessary, the over shall be completed by another bowler, who shall neither have bowled the previous over, or part thereof, nor be allowed to bowl the next over, or part thereof.
- j) The bowler thus taken off shall not be allowed to bowl again in that innings.
- k) The umpire will report the occurrence to the other umpire, the batsmen at the wicket and as soon as possible to the captain of the batting side.
- l) The umpires will then report the matter to the ICC Match Referee who shall take such action as is considered appropriate against the captain and the bowler concerned. (Refer also to Law 42.1 Fair and Unfair Play - Responsibility of the Captains.)
The above is not a substitute for Clause 42.5 below which umpires are able to apply at any time.

42.4.2 Law 42.6 (b) Bowling of High Full Pitched Balls

Law 42.6 (b) shall be replaced by the following:

- a) Any delivery, which passes or would have passed on the full above waist height of the striker standing upright at the popping crease is deemed unfair, whether or not it is likely to inflict physical injury on the striker.
- b) In the event of a bowler bowling a high full pitched ball as defined in Clause 42.4.2 (a) above, the umpire at the bowler's end shall call and signal no ball.
If, in the opinion of the umpire, such a delivery is considered likely to inflict physical injury on the batsman, the umpire at the bowler's end shall, in addition to calling and signalling no ball, when the ball is dead, caution the bowler and issue a first and final warning. The umpire shall inform the other umpire, the captain of the fielding side and the batsmen at the wicket of what has occurred.
- c) Should there be any further instance (where a high full pitched ball is bowled and is considered likely to inflict physical injury on the batsman) by the same bowler in that innings, the umpire shall in addition to calling and signalling no ball, when the ball is dead, direct the captain to take the bowler off forthwith. If necessary, the over shall be completed by another bowler, who shall neither have bowled the previous over, or part thereof, nor be allowed to bowl the next over, or part thereof.

- d) The bowler thus taken off shall not be allowed to bowl again in that innings.
- e) The umpire will report the occurrence to the other umpire, the batsman at the wicket and as soon as possible to the captain of the batting side.
- f) The umpires will then report the matter to the ICC Match Referee who shall take such action as is considered appropriate against the captain and the bowler concerned. (Refer also to Law 42.1 Fair and Unfair Play - Responsibility of the Captains.)

42.5 Law 42.7 - Dangerous and Unfair Bowling - Action by the umpire

Law 42.7 shall be replaced by the following:

Regardless of any action taken by the umpire as a result of a breach of Clauses 42.4.1, 42.4.2 and 42.6 the following shall apply at any time during the match:

- 42.5.1 The bowling of fast short pitched balls is unfair if in the opinion of the umpire at the bowler's end he considers that by their repetition and taking into account their length, height and direction, they are likely to inflict physical injury on the striker, irrespective of the protective clothing and equipment he may be wearing. The relative skill of the striker shall also be taken into consideration.
- 42.5.2 In the event of such unfair bowling, the umpire at the bowler's end shall adopt the following procedure:
 - a) In the first instance the umpire shall call and signal no ball, caution the bowler and inform the other umpire, the captain of the fielding side and the batsmen of what has occurred.
 - b) If this caution is ineffective, he shall repeat the above procedure and indicate to the bowler that this is a final warning.
 - c) Both the above caution and final warning shall continue to apply even though the bowler may later change ends.
 - d) Should there be any further instance by the same bowler in that innings, the umpire shall call and signal no ball and when the ball is dead direct the captain to take the bowler off forthwith. If necessary, the over shall be completed by another bowler, who shall neither have bowled the previous over, or part thereof, nor be allowed to bowl the next over, or part thereof. See Law 22.8. (Bowler Incapacitated or Suspended during an Over).
 - e) The bowler thus taken off shall not be able to bowl again in that innings.
 - f) The umpire will report the occurrence to the other umpire, the batsmen at the wicket and as soon as possible to the captain of the batting side.
 - g) The umpires will then report the matter to the ICC Match Referee who shall take such action as is considered appropriate against the captain and the bowler concerned. (Refer also to Law 42.1 Fair and Unfair Play - Responsibility of the Captains.)

42.6 Law 42.8 - Deliberate bowling of High Full Pitched Balls

Law 42.8 shall be replaced by the following:

If the umpire considers that a high full pitch delivery which is deemed unfair as defined in Clause 42.4.2 was deliberately bowled, then the caution and warning process shall be dispensed with.

The umpire at the bowler's end shall:

- 42.6.1 Call and signal no ball.
- 42.6.2 When the ball is dead, direct the captain to take the bowler off forthwith.
- 42.6.3 Not allow the bowler to bowl again in that innings.
- 42.6.4 Ensure that the over is completed by another bowler, provided that the bowler does not bowl two overs or part thereof consecutively.
- 42.6.5 Report the occurrence to the other umpire, to the captain of the batting side and the ICC Match Referee who shall take such action as is considered appropriate against the captain and the bowler concerned. (Refer also to Law 42.1 Fair and Unfair Play Responsibility of the Captains).

42.7 Action by the umpires for dangerous and unfair Bowling

Should the umpires initiate the caution and warning procedures set out in Clauses 42.4.1, 42.4.2, 42.5 and 42.6 such cautions and warnings are not to be cumulative.

42.8 Law 42.9 - Time Wasting by the Fielding Side

Law 42.9 shall apply subject to Law 42.9 (c) being replaced by the following:

If there is any further waste of time in that innings, by any member of the fielding side the umpire shall:

- 42.8.1 Call and signal dead ball if necessary, and;
- 42.8.2 Award 5 penalty runs to the batting side (see Law 42.17).
- 42.8.3 Inform the other umpire, the batsmen at the wicket and as soon as possible the captain of the batting side of what has occurred.
- 42.8.4 Report the occurrence to the ICC Match Referee who shall take such action as is considered appropriate against the captain and the team concerned under the ICC Code of Conduct.

42.9 Law 42.10 - Batsman Wasting Time

Law 42.10 shall apply, subject to the following:

If the incoming batsman is not in position to take guard or his partner not ready to receive the next ball within 2 minutes of the fall of the previous wicket, the action should be regarded by the umpires as time wasting and the provisions of Law 42.10 shall apply.

In addition, the umpires will report the incident to the ICC Match Referee under the ICC Code of Conduct.

42.10 Law 42.14 Batsman damaging the pitch

Law 42.14 shall apply.

See also clause 37 above.

42.11 Law 42.15 – Bowler attempting to run out non-striker before delivery

Law 42.15 shall be replaced by the following:

The bowler is permitted, before releasing the ball and provided he has not completed his usual delivery swing, to attempt to run out the non-striker. Whether the attempt is successful or not, the ball shall not count as one of the over. If the bowler fails in an attempt to run out the non-striker, the umpire shall call and signal Dead ball as soon possible.

42.12 Use of Electronic Communications Equipment

The use of electronic communication devices and equipment of any kind to communicate with players on the field of play shall not be permitted.

APPENDIX 1

All penalty runs in the Laws of Cricket (2000 Code 5th Edition - 2013) apply in International Cricket.

APPENDIX 2A

Calculation sheet for use when a delay or interruptions occur in the First Innings

Time

Net playing time available at start of the match	420 minutes	(A)
Time innings in progress	_____	(B)
Playing time lost	_____	(C)
Extra time available	_____	(D)
Time made up from reduced interval	_____	(E)
Effective playing time lost [C - (D + E)]	_____	(F)
Remaining playing time available (A - F)	_____	(G)
G divided by 4.2 (to 2 decimal places)	_____	(H)
Max overs per team [H/2] (round up fractions)	_____	(I)
Maximum overs per bowler [I / 5]	_____	
Duration of Powerplay Overs (initial, batting side)	_____ + _____	

Rescheduled Playing Hours

First session to commence or recommence	_____	(J)
Length of innings [I x 4.2] (round up fractions)	_____	(K)
Rescheduled first innings cessation time [J + (K - B)]	_____	(L)
Length of interval	_____	(M)
Second innings commencement time [L + M]	_____	(N)
Rescheduled second innings cessation time [N + K]	_____	*(O)

* Ensure that the match is not finishing earlier than the original or rescheduled cessation time by applying Clause 12.4.2 a) iv). If so, add at least one over to each team and recalculate (I) to (O) above to prevent this from happening.

APPENDIX 2B

Calculation sheet to check whether an interruption during the First Innings should terminate the innings

Proposed re-start time	_____	(P)
Rescheduled cut-off time allowing for full use of any extra time provision	_____	(Q)
Minutes between P and Q	_____	(R)
Potential overs to be bowled [R / 4.2] (round up fractions)	_____	(S)
Number of complete overs faced to date in first innings	_____	(T)

If S is greater than T then revert to Appendix 2A

If S is less than or equal to T then the first innings is terminated and go to Appendix 3A

APPENDIX 3A

Calculation sheet for the start of the Second Innings

Maximum overs to be bowled:

(If first innings was terminated, S from Appendix 2B) _____ (A)

Scheduled length of innings: [$A \times 4.2$] (round up fractions) _____ (B)

Start time _____ (C)

Scheduled cessation time [$C + B$] _____ (D)

Overs per bowler and Fielding Restrictions

Maximum overs per bowler [$A / 5$] _____ overs

Duration of Powerplay overs (initial, batting side) _____ + _____

APPENDIX 3B

Calculation sheet for use when interruption occurs after the start of the Second Innings

Time

Time at start of innings _____ (A)

Time at start of interruption _____ (B)

Time innings in progress _____ (C)

Restart time _____ (D)

Length of interruption [$D - B$] _____ (E)

Additional time available: (Any unused provision for 'Extra Time' or for earlier than scheduled start of second innings) _____ (F)

Total playing time lost [$E - F$] _____ (G)

Overs

Maximum overs at start of innings _____ (H)

Overs lost [$G / 4.2$] (rounded down) _____ (I)

Adjusted maximum length of innings [$H - I$] _____ (J)

Rescheduled length of innings [$J \times 4.2$ rounded up] _____ (K)

Amended cessation time of innings [$D + (K - C)$] _____ (L)

Overs per bowler and Fielding Restrictions

Maximum overs per bowler [$J / 5$] _____ overs

Duration of Powerplay overs (initial, batting side) _____ + _____

APPENDIX 4 - CREASE MARKINGS

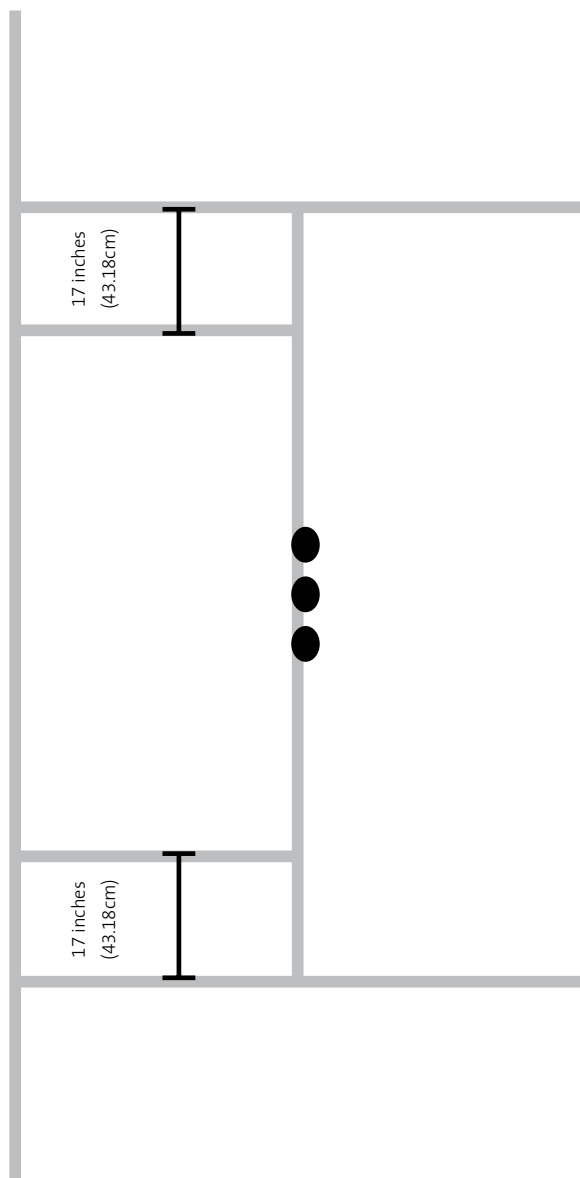

APPENDIX 5

Restriction of the placement of fieldsmen

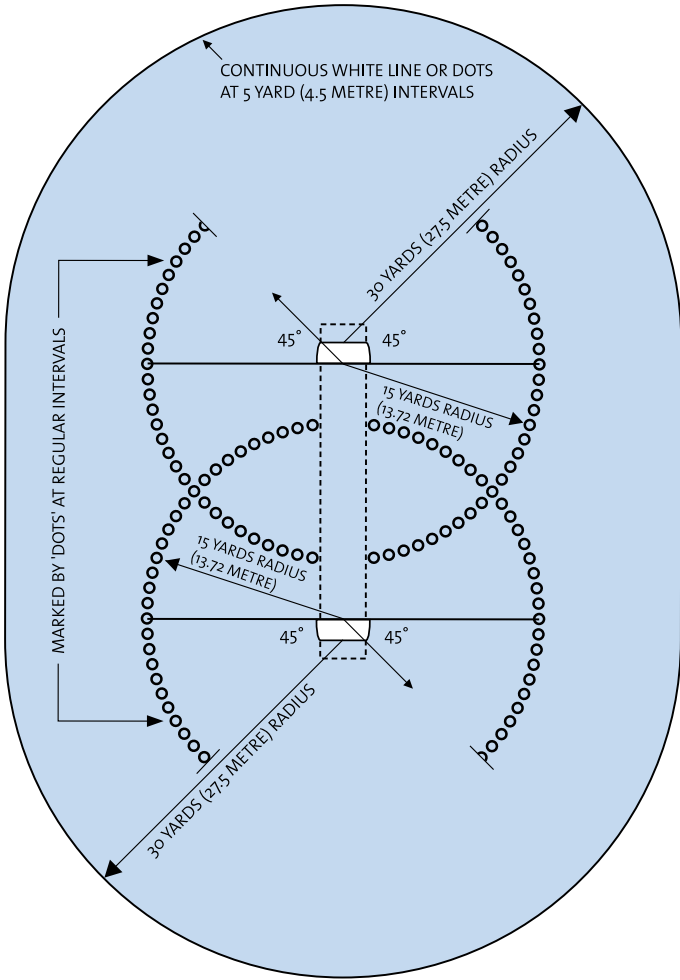

The final mark of the 15 yards radius shall be a line placed at an angle of 45°, measured from the popping crease at a point level with the middle stump.

APPENDIX 6**Bonus Point System**

1 bonus point for any team that achieves victory with a run rate 1.25 times that of the opposition.

A team's run rate will be calculated by reference to the number of runs scored divided by the number of overs/balls faced.

Where a side is all out, the number of overs to be used is the maximum number of overs that side was otherwise eligible to face.

Where matches are shortened and targets revised through the Duckworth/Lewis system, bonus run rates and bonus defensive targets are derived as a function of the revised target score (less one run) and maximum overs.

Whenever a target, or revised target, is set, the exact number of overs/balls within which the side batting second must achieve this target in order to gain the bonus point should be announced. Once these overs/balls have been bowled, if the target has not then been achieved the bonus point cannot be gained by any subsequent event, eg a multiple scoring shot, or extras.

a) Examples of criteria for the award of bonus points

TEAM BATTING FIRST		TEAM BATTING SECOND		TEAM BOWLING SECOND	
SCORE	RUN RATE	REQUIRED RUN RATE	BALLS TO WIN (OVERS)	REQUIRED RUN RATE	TARGET SCORE
300	6	7.5	40.0	4.8	240
275	5.5	6.875	40.0	4.4	220
250	5	6.25	40.0	4	200
225	4.5	5.625	40.1	3.6	180
200	4	5	40.1	3.2	160
175	3.5	4.375	40.1	2.8	140
150	3	3.75	40.1	2.4	120
125	2.5	3.125	40.1	2	100
100	2	2.5	40.2	1.6	80
75	1.5	1.875	40.3	1.2	60

Note: the 'target score' shown in the last column is the maximum total that the team batting second can make for the team batting first to qualify for the bonus point.

APPENDIX 7

Decision Review System (DRS) - Playing Conditions

1 GENERAL

- 1.1 The DRS includes:
 - The process for the referral by the on-field umpires of a decision to the third umpire and/or the consultation process (between the on-field umpire(s) and the third umpire) initiated by the on-field umpire(s) as set out in paragraph 2 below and which have been collectively termed in these playing conditions as an “Umpire Review”; and
 - The process initiated by the players for the review of an on-field umpire’s decision (by means of a consultation between the on-field umpire(s) and the third umpire) as set out in paragraph 3 below and which has been termed in these playing conditions as the “Player Review”.
- 1.2 The Home Board will be required to ensure that the television technology specifications set out in Appendix 8 are provided.
- 1.3 In particular, the Home Board is to ensure that a separate room is provided for the third umpire and that he has access to the television equipment and technology as specified in Appendix 8 so as to be in the best position to facilitate the referral and/or consultation processes referred to in paragraphs 2 (Umpire Review) and 3 (Player Review) below.
- 1.4 The ICC shall appoint an independent technology expert (ICC Technical Official) to be present at every series to assist the third umpire and to protect the integrity of the DRS process.

2 UMPIRE REVIEW

In the circumstances detailed in paragraphs 2.1, 2.2, 2.3, 2.4 and 2.5 below, the on-field umpire has the discretion to refer the decision to the third umpire or, in the case of 2.2(a), 2.4 and 2.5, to consult with the third umpire before making the decision and should take a common sense approach.

Save for requesting the umpire to review his decision under paragraph 3 (Player Review) below, players may not appeal to the umpire to use the Umpire Review - breach of this provision would constitute dissent and the player could be liable for discipline under the ICC Code of Conduct.

The third umpire shall call for as many replays from any camera angle as is necessary to reach a decision. As a guide, a decision should be made within 30 seconds whenever possible, but the third umpire shall have the discretion to take more time.

2.1 Run Out, Stumping and Hit Wicket Decisions

- a) The on-field umpire shall be entitled to refer an appeal for a run-out, stumping or hit wicket to the third umpire.
- b) An on-field umpire wishing to refer a decision to the third umpire shall signal to the third umpire by making the shape of a TV screen with his hands.
- c) In the case of a referral of a hit wicket or stumping decision, the third umpire shall first check the fairness of the delivery (foot-fault, bowler breaking the wicket, waist high full tosses, bouncers above shoulder height). If the delivery was not a fair delivery he shall indicate that the batsman is not out and advise the on-field umpire to signal no ball. See also paragraph 3.10 below.

- d) If the third umpire decides the batsman is out a red light is displayed; a green light means not-out. Should the third umpire be temporarily unable to respond, a white light (where available) will remain illuminated throughout the period of interruption to signify to the on-field umpires that the TV replay system is temporarily unavailable, in which case the decision will be taken by the on-field umpire. (As an alternative to the red/green light system and where available, the big replay screen may be used for the purpose of conveying the third umpire's decision.)
- e) When reviewing the TV replay(s), if the third umpire believes that the batsman may instead be out by any other mode of dismissal, beyond that initially consulted upon, he shall initiate the process described in paragraph 3.3 below as if the batsman has been given not out. This will not count as a Player Review for the purposes of paragraph 3.5.

2.2 Caught Decisions

In the event of an appeal for a caught decision:

- a) Clean Catches
 - i) Should the bowler's end umpire be unable to decide whether or not a catch was taken cleanly, he shall first consult with the square leg umpire.
 - ii) Should both on-field umpires be unable to make a decision, they may consult by two-way radio with the third umpire. Following such consultation, the final decision will be made and given by the bowler's end umpire, who will take into account the on-field umpires' initial views and any other advice received from the third umpire.
 - iii) The third umpire has to determine whether the batsman has been caught. However, in reviewing the television replay(s), the third umpire shall first check the fairness of the delivery (foot-fault, bowler breaking the wicket, waist high full tosses, bouncers above shoulder height) and whether the batsman has hit the ball. If the delivery was not a fair delivery or if it is clear to the third umpire that the batsman did not hit the ball he shall indicate to the on-field umpire that the batsman is not out caught, and in the case of an unfair delivery, advise the on-field umpire to signal no ball. See also paragraph 3.10 below.
 - iv) When reviewing the TV replay(s), if the third umpire believes that the batsman may instead be out by any other mode of dismissal, beyond that initially consulted upon, he shall initiate the process described in paragraph 3.3 below as if the batsman has been given not out. This will not count as a Player Review for the purposes of paragraph 3.5.
- b) Bump Ball
 - i) Should the bowler's end umpire be unable to decide whether a catch was taken from a bump ball or not, he shall first consult with the square leg umpire.
 - ii) Should both on-field umpires be unable to make a decision, the bowler's end umpire shall be entitled to refer the decision to the third umpire to review a TV replay(s) of the batsman's stroke as in paragraph 2.1 (b).
 - iii) The third umpire has to determine whether the ball was a bump ball or not. However, in reviewing the television replay(s), the third umpire shall first check the fairness of the delivery (foot fault and bowler breaking the wicket) and whether the batsman has hit the ball. If the delivery was not a fair delivery or if it is clear to the third umpire that the batsman did not hit the ball he shall indicate that the batsman is not out and, in the case of an unfair delivery, advise the on-field umpire to signal no ball. See also paragraph 3.10 below.

- iv) The third umpire shall communicate his decision by the system as in paragraph 2.1 (d).
- v) When reviewing the TV replay(s), if the third umpire believes that the batsman may instead be out by any other mode of dismissal, beyond that initially consulted upon, he shall initiate the process described in paragraph 3.3 below as if the batsman has been given not out. This will not count as a Player Review for the purposes of paragraph 3.5.

2.3 Boundary Decisions

- a) The on-field umpire shall be entitled to refer to the third umpire for a decision about whether the fieldsman had any part of his person in contact with the ball when he touched the boundary or when he had any part of his person grounded beyond the boundary, or whether a four or six had been scored. A decision is to be made immediately and cannot be changed thereafter.

Note: If the television evidence is inconclusive as to whether or not a boundary has been scored, the status quo will remain, and it shall be treated as runs scored by the batting side.

- b) An on-field umpire wishing the assistance of the third umpire in this circumstance shall communicate with the third umpire by use of a two-way radio and the third umpire will convey his decision to the on-field umpire by this method.
- c) The third umpire may initiate contact with the on-field umpire by two-way radio if TV coverage shows a boundary line infringement or incident that appears not to have been acted upon by the on-field umpires.

2.4 Obstructing the Field

- a) Following an appeal from the fielding side, the on-field umpire shall be entitled to consult with the third umpire if he feels that the batsman, in running between the wickets, may have significantly changed his direction (refer clause 37).
- b) Such consultation shall be initiated by the on-field umpire and will be done to help him decide the extent of any change in direction and whether the obstruction was wilful or not.
- c) Following such consultation with the third umpire, the final decision shall be indicated in the normal fashion by the relevant on-field umpire.

2.5 Batsmen Running to the Same End

- a) In the event of both batsmen running to the same end and the umpires are uncertain over which batsmen made his ground first, the on-field umpire may consult with the third umpire.
- b) The procedure in paragraph 2.3 (b) shall apply.

3 PLAYER REVIEW

The following clauses shall operate in addition to and in conjunction with paragraph 2 (Umpire Review).

3.1 Circumstances in which a Player Review may be requested

- a) A player may request a review of any decision taken by the on-field umpires concerning whether or not a batsman is dismissed, with the exception of 'Timed Out' (Player Review).

- b) For the avoidance of doubt, no other decisions made by the umpires are eligible for a Player Review.
- c) Only the batsman involved in a dismissal may request a Player Review of an 'Out' decision and only the captain (or acting captain) of the fielding team may request a Player Review of a 'Not Out' decision.
- d) A decision concerning whether or not a batsman is dismissed that could have been the subject of a Umpire Review under paragraph 2 is eligible for a Player Review as soon as it is clear that the on-field umpire has chosen not to initiate the Umpire Review.

3.2 The manner of requesting the Player Review

- a) The request should be made by the player making a 'T' sign with both forearms at head height.
- b) The total time elapsed between the ball becoming dead and the review request being made should be no more than 15 seconds. The on-field umpire should provide the player with a prompt after 10 seconds if the request has not been made at that time and the player should request the review immediately thereafter. If the umpires believe that a request has not been made within the 15 second time frame, they will decline to review the decision.
- c) The captain may consult with the bowler and other fielders or the two batsmen may consult with each other prior to deciding whether to request a Player Review. However in order to meet the requirement of (b) above, such consultation will need to occur almost instantly and be very brief. Under no circumstances is any player permitted to query an umpire about any aspect of a decision before deciding on whether or not to request a Player Review. If the umpires believe that the captain or batsman has received direct or indirect input emanating other than from the players on the field, then they may at their discretion decline the request for a Player Review. In particular, signals from the dressing room must not be given.
- d) No replays, either at normal speed or slow motion, should be shown on a big screen to spectators until the time allowed for the requesting of a Player Review has elapsed. See also paragraph 3.11 below.
- e) If either on-field umpire initiates an Umpire Review under paragraph 2, this does not preclude a player seeking a Player Review of a separate incident from the same delivery. The Player Review request may be made after the Umpire Review provided it is still within the timescale described in (b) above. (See 3.8 (b) and 3.8 (c) below for the process for addressing both an Umpire and Player Review).
- f) A request for a Player Review may not be withdrawn once it has been made.

3.3 The process of consultation

- a) On receipt of an eligible and timely request for a Player Review, the on-field umpire will make the sign of a television with his hands in the normal way.
- b) He will initiate communication with the third umpire by confirming the decision that has been made and that the player has requested a Player Review.
- c) The third umpire must then work alone, independent of outside help or comment, other than when consulting the on-field umpire.

- d) A two-way consultation process should begin to investigate whether there is anything that the third umpire can see or hear which would indicate that the on-field umpire should change his decision.
- e) This consultation should be on points of fact, where possible phrased in a manner leading to yes or no answers. Questions requiring a single answer based on a series of judgements, such as “do you think that was LBW?” are to be avoided.
- f) The third umpire shall not withhold any factual information which may help in the decision making process, even if the information is not directly prompted by the on-field umpire’s questions. In particular, in reviewing a dismissal, if the third umpire believes that the batsman may instead be out by any other mode of dismissal, he shall advise the on-field umpire accordingly. The process of consultation described in this paragraph in respect of such other mode of dismissal shall then be conducted as if the batsman has been given not out.
- g) The third umpire should initially check whether the delivery is fair (foot-fault, bowler breaking the wicket, waist high full tosses, bouncers above shoulder height) where appropriate advising the on-field umpire accordingly. See also paragraph 3.10 below.
- h) If despite the available technology, the third umpire is unable to answer with a high degree of confidence a particular question posed by the on-field umpire, then he should report that the replays are ‘inconclusive’. The third umpire should not give answers conveying likelihoods or probabilities.
- i) Subject to paragraph 3.3 (j) below, specifically when advising on LBW decisions, the requirement for a high degree of confidence should be interpreted as follows:
 - i) With regard to determining the point of pitching the evidence provided by technology should be regarded as definitive and the Laws as interpreted in clause 3.9 (a) below should be strictly applied.
 - ii) With regard to the point of impact
 - If a ‘not out’ decision is being reviewed, in order to report that the point of impact is between wicket and wicket (i.e. in line with the stumps), the evidence provided by technology should show that the centre of the ball at the moment of interception is in line within an area demarcated by a line drawn down the middle of the outer stumps.
 - If an ‘out’ decision is being reviewed, in order to report that the point of impact is not between wicket and wicket (i.e. outside the line of the stumps), the evidence provided by technology should show that no part of the ball at the moment of interception is between wicket and wicket.
 - iii) With regard to determining whether the ball was likely to have hit the stumps:
 - If a ‘not out’ decision is being reviewed, in order to report that the ball is hitting the stumps, the evidence provided by technology should show that the centre of the ball would have hit the stumps within an area demarcated by a line drawn below the lower edge of the bails and down the middle of the outer stumps.

However, where the evidence shows that the ball would have hit the stumps within the demarcated area as set out above but that:

- The point of impact is 300cm or more from the stumps; or
 - The point of impact is more than 250cm but less than 300cm from the stumps and the distance between point of pitching and point of impact is less than 40cm,
- the original decision will stand (i.e. not out).
- If an 'out' decision is being reviewed, in order to report that the ball is missing the stumps, the evidence of the technology should show that no part of the ball would have made contact with any part of the stumps or bails.
- j) In circumstances where the television technology (all or parts thereof) is not available to the third umpire or fails for whatever reason, the third umpire shall advise the on-field umpire of this fact but still provide any relevant factual information that may be ascertained from the available television replays and other technology. See also paragraph 3.5 (d).
- k) The on-field umpire must then make his decision based on those factual questions that were answered by the third umpire, any other factual information offered by the third umpire and his recollection and opinion of the original incident.
- l) The on-field umpire will reverse his decision if the nature of the supplementary information received from the third umpire leads him to conclude that his original decision was incorrect.

3.4 The process for communicating the final decision

- a) When the on-field umpire has reached a decision, he should advise the TV director (directly or via the third umpire).
- b) For Player Reviews concerning potential dismissals, he should then indicate "Out" by raising his finger above his head in a normal yet prominent manner or indicate "Not Out" by the call of 'not out' and by crossing his hands in a horizontal position side to side in front and above his waist three times (as per a 'safe' decision in baseball). Where the decision is a reversal of the on-field umpire's previous decision, he should make the 'revoke last signal' indication immediately prior to the above.
- c) If the mode of dismissal is not obvious or not the same as that on which the original decision was based, then the umpire should advise the official scorers via the third umpire.

3.5 Number of Player Review requests permitted

- a) Each team is allowed to make one unsuccessful Player Review requests per innings. If a Player Review results in the umpire reversing his original decision, then the request has been successful and does not count towards the innings limit. If the umpire's decision is unchanged, the Player Review is unsuccessful. After one unsuccessful request by one team, no further Player Review requests will be allowed by that team during the current innings.
- b) If following a Player Review, an umpire upholds a decision of 'Out', but for a different mode of dismissal from that for which the original decision was given, then the request will still be regarded as unsuccessful.
- c) If following a Player Review, an umpire upholds a decision of 'Not Out' on account of the delivery being a no ball for any reason, thereby not requiring any review of the ball's subsequent trajectory, then this will not be counted as an unsuccessful request and not count towards the innings limit.

- d) If a Player Review and an Umpire Review occur from the same delivery and the decision from the Umpire Review renders the Player Review unnecessary (see 3.8 (b) and 3.8 (c)), then the Player Review request will be ignored and not be counted as unsuccessful.
- e) An unsuccessful review may be re-instated by the Match Referee at his sole discretion (if appropriate after consultation with the ICC Technical Official and/or the television broadcast director), if the review could not properly be concluded due to a failure of the technology. Any such decision shall be final and should be taken as soon as possible once all the relevant facts have been ascertained by the Match Referee. An unsuccessful review shall not be re-instated if, despite any technical failures, the correct decision could still have been made using the other available technology. Similarly, no reinstatement shall be made where the technology worked as intended, but the evidence gleaned from its use was “inconclusive”.
- f) The third umpire shall be responsible for counting the number of unsuccessful Player Reviews and advising the on-field umpires once either team has exhausted their allowance for that innings.
- g) The scoreboard shall display, for the innings in progress, the number of Player Reviews remaining available to each team.

3.6 Dead ball

- a) If following a Player Review request, an original decision of ‘Out’ is changed to ‘Not Out’, then the ball is still deemed to have become dead when the original decision was made (as per Law 23.1(a)(iii)). The batting side, while benefiting from the reversal of the dismissal, will not benefit from any runs that may subsequently have accrued from the delivery had the on-field umpire originally made a ‘Not Out’ decision, other than any No Balls penalty that could arise under 3.3 (g) above.
- b) If an original decision of ‘Not Out’ is changed to ‘Out’, the ball will retrospectively be deemed to have become dead from the moment of the dismissal event. All subsequent events, including any runs scored, are ignored.

3.7 Use of technology

- a) The following technology may be used by the third umpire.
 - Slow motion replays from all available cameras
 - Super slow motion replays from all available cameras
 - Ultra motion camera replays from all available cameras
 - Sound from the stump microphones with the replays at normal speed and slow motion
 - Approved ball tracking technology
 - The mat, generated by the provider of ball tracking technology, not by the broadcaster
 - Hot Spot cameras
 - Zing Wickets (using the lights to indicate if the wicket is broken).

In addition, other forms of technology may be used subject to ICC being satisfied that the required standards of accuracy and time efficiency can be met.

- b) Where practical usage or further testing indicates that any of the above forms of technology cannot reliably provide accurate and timely information, then it may be removed prior to or during a match. The final decision regarding the technology to be used in a given match will be taken by the ICC Match Referee in consultation with the ICC Technical Official, ICC Management and the competing teams' governing bodies.

3.8 Combining Umpire Reviews with Player Reviews

- a) If an Umpire Review (under Clause 2) and a Player Review request are made following the same delivery but relating to separate modes of dismissal, the following procedure shall apply.
- b) The Umpire Review should be carried out prior to the Player Review if **all** of the following conditions apply:
 - i) The Player Review has been requested by the fielding side
 - ii) The Umpire Review and the Player Review both relate to the dismissal of the same batsman
 - iii) If the batsman is out, the number of runs scored from the delivery would be the same for both modes of dismissal
 - iv) If the batsman is out, the batsman on strike for the next delivery would be the same for both modes of dismissal.
- c) If the Umpire Review leads the third umpire to make a decision of 'Out', then this will be displayed in the usual manner and the Player Review will not be performed. If the Umpire Review results in a not out decision, then the third umpire will make no public decision but proceed to address the Player Review request.

For illustration, following an unsuccessful lbw appeal, the striker sets off for a run, is sent back and there is an appeal for his run out. The players request that the lbw decision is reviewed and the umpires request that the run out be reviewed. The four criteria above are satisfied, so the run out referral is determined first. Should the appeal for run out be 'Out', then there is no requirement for the lbw review to take place.

- d) In all other circumstances, the two incidents shall be addressed in chronological order. If the conclusion from the first incident is that a batsman is dismissed, then the ball would be deemed to have become dead at that point, rendering investigation of the second incident unnecessary.

3.9 Interpretation of Laws

- a) When using technology to determine where the ball pitched (as per Law 36.1(b)), the third umpire should refer to the "point" (or centre) of the ball. Therefore if at least 50% of the ball pitches outside the line of leg stump, then no LBW dismissal is possible.
- b) When using a replay to determine the moment at which the wicket has been put down (as per Law 28.1), the third umpire should deem this to be the first frame in which one of the bails is shown (or can be deduced) to have lost **all** contact with the top of the stumps and subsequent frames show the bail permanently removed from the top of the stumps.

3.10 No Balls

Following any mode of dismissal that is not permitted off a no ball and which is not the subject of an Umpire or Player Review, if the on-field umpire is uncertain as the fairness of the delivery (foot-fault, bowler breaking the wicket, waist high full tosses, bouncers above shoulder height), he shall be entitled to request the batsman to delay leaving the field and to check the fairness of the delivery with the third umpire. Consultation with the third umpire shall be by way of two way radio. If the delivery was not a fair delivery the on-field umpire shall indicate that the batsman is not-out and signal no-ball. For the avoidance of doubt, the third umpire shall apply clause 24.3 when deciding whether a no-ball should have been called.

3.11 Big Screen Policy

The current ICC big screen policy will apply.

See also 3.2(d)

APPENDIX 8

DRS Third Umpire Room and Television Broadcast Specifications

Specifications will be circulated separately.

APPENDIX 9

Third Umpire TV Replay System – Playing Conditions

1 GENERAL

- 1.1 Save with the express written consent of the Chief Executive Officer of the ICC the Home Board will ensure the live television broadcast of all ODI Matches played in its country.
- 1.2 Where matches are broadcast the camera specification set out in Appendix 9 A shall be mandatory as a minimum requirement.
- 1.3 Where matches are not broadcast the camera specifications set out in Appendix 9 B shall be mandatory as a minimum requirement.
- 1.4 The Home Board will ensure a separate room is provided for the third umpire and that he has access to television monitors and direct sound link with the television control broadcast director to facilitate as many replays as is necessary to assist him in making a decision.
- 1.5 The provisions of clauses 1.1, 1.2, 1.3 and 1.4 above shall not apply for series between a Full Member country and Associate/Affiliate Member countries (whose matches have been granted ODI status) and for series between such Associate/Affiliate Member countries.
- 1.6 In the circumstances detailed in paragraphs 2, 3, 4, 5 and 6 below, the on-field umpire has the discretion to refer the decision to the third umpire or, in the case of paragraph 3.1, 5 and 6 to consult with the third umpire before making his decision and should take a common sense approach.

Players may not appeal to the umpire to use the replay system - breach of this provision would constitute dissent and the player could be liable for discipline under the ICC Code of Conduct.
- 1.7 The third umpire shall call for as many replays from any camera angle as is necessary to reach a decision. As a guide, a decision should be made within 30 seconds whenever possible, but the third umpire shall have a discretion to take more time in order to finalise a decision.
- 1.8 The third umpire shall only have access to TV replays for the provisions of paragraphs 2, 3, 4, 5 and 6 below. Other technology which may be in use by the broadcaster for broadcast purposes (Hot Spot, ball tracking, Snicko) shall not be permitted.

2 RUN OUT, STUMPING AND HIT WICKET DECISIONS

- 2.1 The on-field umpire shall be entitled to refer an appeal for a run-out, stumping or hit wicket to the third umpire.
- 2.2 An on-field umpire wishing to refer a decision to the third umpire shall signal to the third umpire by making the shape of a TV screen with his hands.
- 2.3 If the third umpire decides the batsman is out a red light is displayed; a green light means not-out. Should the third umpire be temporarily unable to respond, a white light (where available) will remain illuminated throughout the period of interruption to signify to the on-field umpires that the TV replay system is temporarily unavailable, in which case the decision will be taken by the on-field umpire. (As an alternative to the red/green light system and where available, the big screen may be used for the purpose of conveying the third umpire's decision.)

- 2.4 When reviewing the TV replay(s), the third umpire shall first check the fairness of the delivery (foot fault, bowler breaking the wicket, waist high full tosses, bouncers above shoulder height). Additionally, if the third umpire finds the batsman is out by another mode of dismissal (excluding LBW), or not out by any mode of dismissal (excluding LBW), he shall notify the on-field umpire so that the correct decision is made.
- 2.5 Zing Wickets are permitted to be used for run-out, stumping and hit wicket decisions (using the lights to determine if the wicket is broken).

3 CAUGHT DECISIONS

The on-field umpire shall be entitled to refer an appeal for a caught decision to the third umpire in the following circumstances:

3.1 Clean Catches

- a) Should the bowler's end umpire be unable to decide whether or not a catch was taken cleanly, he shall first consult with the square leg umpire.
- b) Should both umpires be unable to make a decision, they may consult by two-way radio with the third umpire. Following such consultation, the final decision will be made and given by the bowler's end umpire, who will take into account the on-field umpires' initial views and any other advice received from the third umpire.
- c) The third umpire has to determine whether the batsman has been caught. However, when reviewing the television replay(s), the third umpire shall first check the fairness of the delivery (foot fault, bowler breaking the wicket, waist high full tosses, bouncers above shoulder height). Additionally, if it is clear to the third umpire that the batsman did not hit the ball, or is not out by another mode of dismissal (excluding LBW), or out by any mode of dismissal (excluding LBW), he shall notify the on-field umpire so that the correct decision is made.
- d) The final decision shall be indicated in the normal fashion by the bowler's end umpire.

3.2 Bump Ball

- a) Should the bowler's end umpire be unable to decide whether a catch was taken from a bump ball or not, he shall first consult with the square leg umpire.
- b) Should both on-field umpires be unable to make a decision, the bowler's end umpire shall be entitled to refer the decision to the third umpire to review a TV replay(s) of the batsman's stroke as in paragraph 2.2.
- c) The third umpire has to determine whether the ball was a bump ball or not. However, when reviewing the television replay(s), the third umpire shall first check the fairness of the delivery (foot fault and bowler breaking the wicket). Additionally, if it is clear to the third umpire that the batsman did not hit the ball or is not out by another mode of dismissal (excluding LBW), or out by any mode of dismissal (excluding LBW), he shall notify the on-field umpire so that the correct decision is made.
- d) The third umpire shall communicate his decision by the system as in paragraph 2.3.

4 BOUNDARY DECISIONS

- 4.1 The on-field umpire shall be entitled to refer to the third umpire for a decision about whether the fieldsman had any part of his person in contact with the ball when he touched the boundary or when he had any part of his person grounded beyond the boundary, or whether a four or six had been scored. A decision is to be made immediately and cannot be changed thereafter.
- 4.2 An on-field umpire wishing the assistance of the third umpire in this circumstance shall communicate with the third umpire by use of a two-way radio and the third umpire will convey his decision to the on-field umpire by this method.
- 4.3 The third umpire may initiate contact with the on-field umpire by two-way radio if TV coverage shows a boundary line infringement or incident that appears not to have been acted upon by the on-field umpires.

5 OBSTRUCTING THE FIELD

- a) Following an appeal from the fielding side, the on-field umpire shall be entitled to consult with the third umpire if he feels that the batsman, in running between the wickets, may have significantly changed his direction (refer clause 37).
- b) Such consultation shall be initiated by the on-field umpire and will be done to help him decide the extent of any change in direction and whether the obstruction was wilful or not.
- c) Following such consultation with the third umpire, the final decision shall be indicated in the normal fashion by the bowler's end umpire.

6 BATSMEN RUNNING TO THE SAME END

- 6.1 In the event of both batsmen running to the same end and the umpires are uncertain over which batsman made his ground first, the on-field umpire may consult with the third umpire.
- 6.2 The procedure in paragraph 4.2 shall apply.

7 NO BALLS

Following any mode of dismissal that is not permitted off a no ball, if the on-field umpire is uncertain as the fairness of the delivery (foot-fault, bowler breaking the wicket, waist high full tosses, bouncers above shoulder height), he shall be entitled to request the batsman to delay leaving the field and to check the fairness of the delivery with the third umpire. Consultation with the third umpire shall be by way of two way radio. If the delivery was not a fair delivery the on-field umpire shall indicate that the batsman is not-out and signal no-ball. For the avoidance of doubt, the third umpire shall apply clause 24.3 when deciding whether a no-ball should have been called.

APPENDIX 9A

Generic Camera Layout - Basic TV Coverage

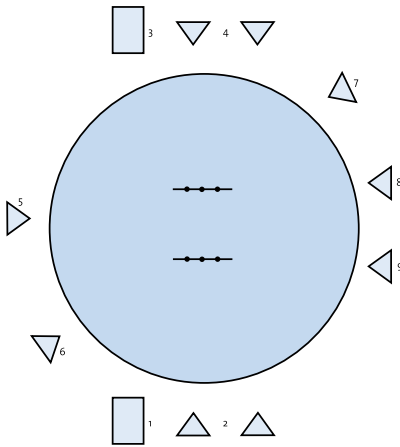

- 1 Wicket to Wicket
- 2 Follow
- 3 Wicket to Wicket
- 4 Follow
- 5 Square Leg/Mid Wicket
- 6 Slips
- 7 Slips
- 8 Line / Run out Cam
- 9 Line / Run out Cam

APPENDIX 9B

Generic Camera Layout - Third Umpire Coverage

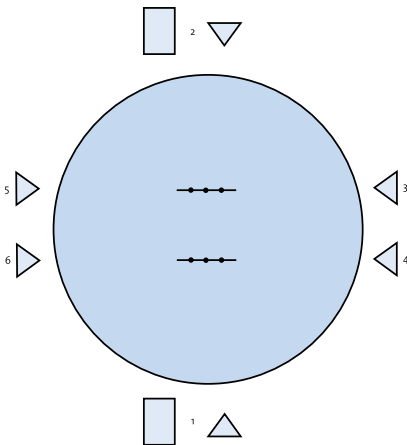

- 1 Follow
- 2 Follow
- 3 Line / Run out Cam
- 4 Line / Run out Cam
- 5 Line / Run out Cam
- 6 Line / Run out Cam

APPENDIX 10

Application of the Reserve Day

Example 1:

Match starts at 50 overs per side and there is an interruption at 19 overs. Overs are reduced to 46 overs per side and play is about to resume.

Before another ball is bowled it rains and play is abandoned for the day.

As the match didn't resume under the revised overs, the match should continue on the reserve day at the original 50 overs per side with the overs reduced if necessary during the day.

Example 2:

The same start as in example 1 i.e. match starts at 50 overs per side and there is an interruption at 19 overs. Overs are reduced to 46 overs per side and play is about to resume.

This time, play starts and after an over has been bowled it rains and play is abandoned for the day.

As the match has resumed, it is continued on the reserve day at 46 overs per side with the overs reduced if necessary during the day.

Example 3:

The toss occurs on the scheduled day but the match is abandoned for the day without a ball being bowled.

When play commences on the reserve day:

- The captains shall not be entitled to re-toss (and nominate new teams) unless by agreement between the two captains; and
- These matches shall always be regarded in the records as a single match.

Note: If the reserve day is utilised, the hours of play on the reserve day are the same as the scheduled hours of play on the scheduled day, including any provision for extra time. The amount of extra time available on the reserve day cannot exceed that which was available on the scheduled day.

STANDARD **TWENTY20 INTERNATIONAL**
MATCH PLAYING CONDITIONS

STANDARD TWENTY20 INTERNATIONAL MATCH PLAYING CONDITIONS

These playing conditions are applicable to all Twenty20 Internationals from 1st October 2013 and supersede the previous version dated 30 April 2013. Included in this version are amendments to clause 1.3, 2.2.2, 17.1, 17.2, 19.3, 21.5, 23.1, 41.2, 42.1, 42.1.1, Appendices 2, 3, 6 and 7 and new clauses 8.2, 24.3 and 42.1.2.

Except as varied hereunder the Laws of Cricket (2000 Code 5th Edition - 2013) shall apply.

Note: All references to 'Governing Body' within the Laws of Cricket shall be replaced by 'ICC Match Referee'.

1 LAW 1 THE PLAYERS

1.1 Law 1.1 - Number of Players

Law 1.1 shall be replaced by the following:

A match is played between two sides. Each side shall consist of 11 players, one of whom shall be captain.

1.2 Law 1.2 - Nomination of Players

Law 1.2 shall be replaced by the following:

- 1.2.1 Each captain shall nominate 11 players plus a maximum of 4 substitute fielders in writing to the ICC Match Referee before the toss. No player (member of the playing eleven) may be changed after the nomination without the consent of the opposing captain.
- 1.2.2 Only those nominated as substitute fielders shall be entitled to act as substitute fielders during the match, unless the ICC Match Referee, in exceptional circumstances, allows subsequent additions.
- 1.2.3 All those nominated including those nominated as substitute fielders, must be eligible to play for that particular team and by such nomination the nominees shall warrant that they are so eligible.
- 1.2.4 In addition, by their nomination, the nominees shall be deemed to have agreed to abide by all the applicable ICC Regulations pertaining to international cricket and in particular, the Clothing and Equipment Regulations, the Code of Conduct for Players and Player Support Personnel (hereafter referred to as the ICC Code of Conduct), the Anti-Racism Code for Players and Player Support Personnel, the Anti-Doping Code and the Anti-Corruption Code.

1.3 Law 1.3 – Captain

The following shall apply in addition to Law 1.3 (a):

The deputy must be one of the nominated members of the playing eleven.

Each Member Board must nominate its 'T20 Team Captain' to the ICC when appointed.

If the 'T20 Team Captain' is not participating in a series, the relevant Home Board must nominate a replacement 'T20 Team Captain' for the series. The Home Board shall advise the series Match Referee.

If the 'T20 Team Captain' plays in a match without being the nominated captain for that match, he will be deemed to be the captain should any penalties be applied for over rate breaches under the Code of Conduct.

2 LAW 2 - SUBSTITUTES AND RUNNERS, BARMAN OR FIELDER LEAVING THE FIELD, BATSMAN RETIRING, BATSMAN COMMENCING INNINGS

Law 2 shall apply subject to the following:

2.1 Law 2.1 Substitutes and Runners

Law 2.1 (a) (ii), 2.7 and 2.8 shall not apply. A runner for a batsman when batting is not permitted.

Law 2.1 (b) shall be amended as follows:

The umpires shall have discretion to allow, for other wholly acceptable reasons, a substitute fielder to act for a nominated player, at the start of the match, or at any subsequent time.

2.2 Law 2.5 - Fielder absent or leaving the field

Law 2.5 shall be replaced by the following:

If a fielder fails to take the field with his side at the start of the match or at any later time, or leaves the field during a session of play, the umpire shall be informed of the reason for his absence, and he shall not thereafter come on to the field during a session of play without the consent of the umpire. (See Law 2.6 as modified). The umpire shall give such consent as soon as practicable.

If the player is absent from the field for longer than 8 minutes:

- 2.2.1 the player shall not be permitted to bowl in that innings after his return until he has been on the field for at least that length of playing time for which he was absent.
- 2.2.2 the player shall not be permitted to bat unless or until, in the aggregate, he has returned to the field and/or his side's innings has been in progress for at least that length of playing time for which he has been absent or, if earlier, when his side has lost five wickets.

The restriction in Clauses 2.2.1 and 2.2.2 above shall not apply if the player has suffered an external blow (as opposed to an internal injury such as a pulled muscle) whilst participating earlier in the match and consequently been forced to leave the field. Nor shall it apply if the player has been absent for very exceptional and wholly acceptable reasons (other than injury or illness).

In the event of a batsman or a fieldsman already being off the field at the commencement of an interruption in play through ground, weather or light conditions or for other exceptional circumstances, he shall be allowed to count any such stoppage time as playing time, provided that he personally informs the umpires when he is fit enough to take the field had play been in progress. Similarly, if at the commencement of an interruption in play through ground, weather or light conditions or for other exceptional circumstances, a player is on the field but still has some unexpired penalty time remaining from a previous absence, he shall automatically be allowed to count any such stoppage time as playing time.

- 2.2.3 Substitute fielders shall only be permitted in cases of injury, illness or other wholly acceptable reasons. 'Wholly acceptable reasons' should be limited to extreme circumstances and should not include what is commonly referred to as a 'comfort break'.

Note: Squad members of the fielding team who are not playing in the match and who are not acting as substitute fielders shall be required to wear a team training bib whilst on the playing area (including the area between the boundary and the perimeter fencing).

3 LAW 3 - THE UMPIRES**3.1 Law 3.1 - Appointment and attendance**

Law 3.1 shall be replaced by the following:

The following rules for the selection and appointment of umpires shall be followed as far as it is practicable to do so:

- 3.1.1 The umpires shall control the game as required by the Laws (as read with these playing conditions), with absolute impartiality and shall be present at the ground at least two hours before the scheduled start of play.
- 3.1.2 ICC shall establish an 'Elite Panel' of umpires who shall be contracted to the ICC.
- 3.1.3 Each Full Member country shall nominate from its panel of first class umpires two umpires to an 'International Panel' and one umpire to a 'TV Panel'. (A third umpire may be nominated to the 'International Panel' with the written consent of the ICC).
- 3.1.4 The Home Board shall appoint both umpires to stand in each T20I match. Such umpires shall be selected from the 'Elite Panel' or the 'International Panel'.
- 3.1.5 The Home Board shall appoint a third umpire for each T20I match who shall act as the emergency umpire and officiate in regard to TV replays. Such appointment must be made from the 'International Panel' or the 'TV Panel'.
- 3.1.6 The Home Board shall also appoint a fourth umpire for each T20I match from its panel of first class umpires. The fourth umpire shall act as the emergency third umpire.
- 3.1.7 ICC shall appoint a match referee for all matches (ICC Match Referee).
- 3.1.8 The ICC Match Referee shall not be from the same country as the participating teams.
- 3.1.9 Neither team will have a right of objection to an umpire's or match referee's appointment.

3.2 Third Umpires / TV Replay System

The playing conditions set out in Appendix 6 shall apply.

3.3 Law 3.2 - Change of Umpire

Law 3.2 shall be replaced by the following:

An umpire shall not be changed during the match, other than in exceptional circumstances, unless he is injured or ill.

3.4 Law 3.4 - To inform captains and scorers

The following shall apply in addition to Law 3.4 (i):

The Home Board may provide for the ringing of a bell, which shall be rung 5 minutes before the termination of an interval, when the umpires shall go to the wickets. The Home Board shall inform the ICC Match Referee and the Manager of the visiting team at the start of the tour that this practice is to be adopted.

3.5 Law 3.8 - Fitness for play and Law 3.9 - Suspension of play in dangerous or unreasonable conditions

3.5.1 The safety of all persons within the ground is of paramount importance to the ICC. In the event that any threatening circumstance, whether actual or perceived, comes to the attention of any umpire (including for example weather, pitch invasions, act of God, etc. See also clauses 3.5.4 and 3.5.5 below), then the players and officials should immediately be asked to leave the field of play in a safe and orderly manner and to relocate to a secure and safe area (depending on each particular threat) pending the satisfactory passing or resolution of such threat or risk to the reasonable satisfaction of the umpires, ICC Match Referee, the head of the relevant ground authority, the head of ground security and/or the police as the circumstances may require.

Laws 3.8 & 3.9 shall be replaced by:

3.5.2 The umpires shall be the final judges of the fitness of the ground, weather and light for play. See clause 3.5.3 below and Law 7.2 (Fitness of the pitch for play).

3.5.3 Suspension of play for adverse conditions of ground, weather or light

- a) All references to ground include the pitch. See Law 7.1 (Area of pitch).
- b) If at any time the umpires together agree that the conditions of ground, weather or light are so bad that there is obvious and foreseeable risk to the safety of any player or umpire, so that it would be unreasonable or dangerous for play to take place, then they shall immediately suspend play, or not allow play to commence or to restart. The decision as to whether conditions are so bad as to warrant such action is one for the umpires alone to make.

The fact that the grass and the ball are wet and slippery does not warrant the ground conditions being regarded as unreasonable or dangerous. If the umpires consider the ground is so wet or slippery as to deprive the bowler of a reasonable foothold, the fielders of the power of free movement, or the batsmen of the ability to play their strokes or to run between the wickets, then these conditions shall be regarded as so bad that it would be unreasonable for play to take place.

The umpires shall disregard any shadow on the pitch from the stadium or from any permanent object on the ground.

- c) When there is a suspension of play it is the responsibility of the umpires to monitor the conditions. They shall make inspections as often as appropriate. Immediately the umpires together agree that conditions are suitable for play they shall call upon the players to resume the game.
- d) If play is in progress up to the start of an agreed interval then it will resume after the interval unless the umpires together agree that the conditions of ground, weather or light are so bad that there is obvious and foreseeable risk to the safety of any player or umpire, so that it would be unreasonable or dangerous for play to take place.

3.5.4 Play may be suspended due to safety and security concerns by the umpires on the advice of the ICC Match Referee, the head of the relevant ground authority, the head of ground security or the police.

- 3.5.5 Where play is suspended under Clause 3.5.4 above the decision to abandon or resume play shall be the responsibility of the ICC Match Referee who shall act only after consultation with the head of ground security and the police.

3.6 Light Meters

- 3.6.1 It is the responsibility of the ICC to supply light meters to the match officials to be used in accordance with these playing conditions.
- 3.6.2 All light meters shall be uniformly calibrated.
- 3.6.3 The umpires shall be entitled to use light meter readings as a guideline for determining whether the light is fit for play in accordance with the criteria set out in clause 3.5.3 (b) above.
- 3.6.4 Light meter readings may accordingly be used by the umpires:
- To determine whether there has been at any stage a deterioration or improvement in the light.
 - As benchmarks for the remainder of a stoppage, match and/or series/event.

3.7 Use of artificial lights

In the event of power failure or lights malfunction, the provisions relating to the delay or interruption of play due to bad weather or light shall apply.

3.8 Day Night matches

- 3.8.1 Pads and players' and umpires' clothing shall be coloured.
- 3.8.2 Sight screens will be black.

3.9 Advertising on grounds, perimeter boards and sightcreens

3.9.1 Advertising on grounds

The logos on outfields are to be positioned as follows:

- Behind the stumps – a minimum of 25.15 yards (23 meters) from the stumps.
- Midwicket/cover area – no advertising to be positioned within the 30 yard (27.50 meters) circle.

Note: Advertising closer to the stumps as set out above which is required to meet 3D requirements for broadcasters may be permitted, subject to prior ICC approval having been obtained.

3.9.2 Perimeter Boards

- Advertising on perimeter boards placed in front of the sightcreens is permitted save that the predominant colour of such advertising shall be of a contrasting colour to that of the ball.
- Advertising on perimeter boards behind the stumps at both ends shall not contain moving, flashing or flickering images and operators should ensure that the images are only changed or moved at a time that will not be distracting to the players or the umpires.
- In addition, the brightness of any electronic images shall be set at a level so that it is not a distraction to the players or umpires.

3.9.3 Sightscreens

- a) Sightscreens shall be provided at both ends of all grounds.
- b) Advertising shall be permitted on the sightscreen behind the striker, providing it is removed for the subsequent over from that end.
- c) Such advertising shall not contain flashing or flickering images and particular care should be taken by the operators that the advertising is not changed at a time which is distracting to the umpire.

4 LAW 4 - THE SCORERS

Law 4 shall apply.

5 LAW 5 - THE BALL

5.1 Law 5.2 - Approval and control of balls

Law 5.2 shall be replaced by the following:

The Home Board shall provide cricket balls of an approved standard for T20I cricket and spare used balls for changing during a match, which shall also be of the same brand. Note: The Home Board shall be required to advise the Visiting Boards of the brand of ball to be used in the match(es) at least 30 days prior to the start of the match(es).

The fielding captain or his nominee may select the ball with which he wishes to bowl from the supply provided by the Home Board. The fourth umpire shall take a box containing at least 6 new balls to the dressing room and supervise the selection of the ball.

The umpires shall retain possession of the match ball(s) throughout the duration of the match when play is not actually taking place. During play umpires shall periodically and irregularly inspect the condition of the ball and shall retain possession of it at the fall of a wicket or any other disruption in play. Where day/night matches are scheduled in a series white balls will be used in all matches (including day matches). Each fielding team shall have one new ball for its innings.

5.2 Law 5.4 - New ball in match of more than one day's duration

Law 5.4 shall not apply.

5.3 Law 5.5 - Ball lost or becoming unfit for play

Law 5.5 shall be replaced by the following:

- 5.3.1 In the event of a ball during play being lost or in the opinion of the umpires, being unfit for play through normal use, the umpires shall allow it to be replaced by one that in their opinion has had a similar amount of wear.
- 5.3.2 In the event of the ball becoming wet and soggy as a result of play continuing in inclement weather or it being affected by dew, or a white ball becoming significantly discoloured and in the opinion of the umpires being unfit for play, the ball may be replaced for a ball that has similar amount of wear, even though it has not gone out of shape.
- 5.3.3 If the ball is to be replaced, the umpire shall inform the batsmen and the fielding captain. Either batsman or bowler may raise the matter with the umpires and the umpires' decision as to a replacement or otherwise will be final.

5.4 Law 5.6 - Specifications

Law 5.6 shall not apply.

6 LAW 6 - THE BAT

The following shall apply in addition to Law 6:

Only Type A bats shall be used in T20I matches.

7 LAW 7 - THE PITCH**7.1 Law 7.3 - Selection and preparation**

The following will apply in addition to Law 7.3:

- 7.1.1 The ground staff shall ensure that during the period prior to the start of play and during intervals, the pitch area shall be roped off so as to prevent unauthorised access. (The pitch area shall include an area at least 2 metres beyond the rectangle made by the crease markings at both ends of the pitch).
- 7.1.2 The fourth umpire shall ensure that, prior to the start of play and during any intervals, only authorised ground staff, the ICC match officials, players, team coaches and authorised television personnel shall be allowed access to the pitch area. Such access shall be subject to the following limitations:
- Only captains and team coaches may walk on the actual playing surface of the pitch area (outside of the crease markings).
 - Access to the pitch area by television personnel shall be restricted to one camera crew (including one or two television commentators) of the official licensed television broadcaster(s) (but not news crews).
 - No spiked footwear shall be permitted.
 - No one shall be permitted to bounce a ball on the pitch, strike it with a bat or cause damage to the pitch in any other way.
 - Access shall not interfere with pitch preparation.
- 7.1.3 In the event of any dispute, the ICC Match Referee will rule and his ruling will be final.

7.2 Law 7.4 - Changing the pitch

Law 7.4 shall be replaced by the following:

- 7.2.1 In the event of a pitch being considered too dangerous for play to continue in the estimation of the on-field umpires, they shall stop play and immediately advise the ICC Match Referee.
- 7.2.2 The on-field umpires and ICC Match Referee shall consult with both captains.
- 7.2.3 If the captains agree to continue, play shall resume.
- 7.2.4 If the decision is not to resume play, the on-field umpires together with the ICC Match Referee shall consider whether the existing pitch can be repaired and the match resumed from the point it was stopped. In considering whether to authorise such repairs, the ICC Match Referee must consider whether this would place either side at an unfair advantage, given the play that had already taken place on the dangerous pitch.

- 7.2.5 If the decision is that the existing pitch cannot be repaired, then the match is to be abandoned with the following consequences:
- a) In the event of the required number of overs to constitute a match having been completed at the time the match is abandoned, the result shall be determined according to the provisions of clause 21.7.2.
 - b) In the event of the required number of overs to constitute a match not having been completed, the match will be abandoned as a no result.
- 7.2.6 If the match is abandoned as a no result, the ICC Match Referee shall consult with the Home Board with the objective of finding a way for a new match to be commenced and completed on the same date (including any reserve day) and venue.
- 7.2.7 Such a match may be played either on the repaired pitch or on another pitch, subject to the ICC Match Referee and the relevant ground authority both being satisfied that the new pitch will be of the required T20I standard. The playing time lost between the scheduled start time of the original match and the actual start time of the new match will be covered by the provisions of clauses 12 and 16 below.
- 7.2.8 If it is not possible to play a new match on the scheduled day of the match (including any reserve day), the relevant officials from the participating Boards shall agree on whether the match can be replayed within the existing tour schedule.
- 7.2.9 Throughout the above decision making processes, the ICC Match Referee shall keep informed both captains and the head of the ground authority. The head of the ground authority shall ensure that suitable and prompt public announcements are made.

7.3 Law 7.5 - Non-turf pitches

Law 7.5 shall not apply.

All matches shall be played on natural turf pitches. The use of PVA and other adhesives in the preparation of pitches is not permitted.

8 LAW 8 - THE WICKETS

8.1 Law 8.2 - Size of stumps

The following shall apply in addition to Law 8.2:

For televised matches the Home Board may provide a slightly larger cylindrical stump to accommodate the stump camera. When the larger stump is used, all three stumps must be exactly the same size.

8.2 Zing Wickets

The use of Zing wickets is permitted.

Refer also to Appendix 6 clause 2.5.

9 LAW 9 - THE BOWLING, POPPING AND RETURN CREASES

9.1 Law 9.3 - The Popping Crease

Law 9.3 shall apply, except that the reference to 'a minimum of 6 ft' shall be replaced by 'a minimum of 15 yards (13.71 metres)'.

9.2 Additional Crease Markings

The following shall apply in addition to Law 9:

As a guideline to the umpires for the calling of wides on the offside the crease markings detailed in Appendix 4 shall be marked in white at each end of the pitch.

10 LAW 10 - PREPARATION AND MAINTENANCE OF THE PLAYING AREA**10.1 Law 10.1 - Rolling**

The following shall apply in addition to Law 10.1:

- 10.1.1 Prior to tossing for choice of innings the artificial drying of the pitch and outfield shall be at the discretion of the ground curator. Thereafter and throughout the match the drying of the outfield may be undertaken at any time by the ground curator, but the drying of the affected area of the pitch shall be carried out only on the instructions and under the supervision of the umpires. The umpires shall be empowered to have the pitch dried without reference to the captains at any time they are of the opinion that it is unfit for play.
- 10.1.2 The umpires may instruct the ground curator to use any available equipment, including any roller for the purpose of drying the pitch and making it fit for play.
- 10.1.3 An absorbent roller may be used to remove water from the covers including the cover on the match pitch.

10.2 Law 10.6 - Maintenance of footholes

The following shall apply in addition to Law 10.6:

The umpires shall see that wherever possible and whenever it is considered necessary, action is taken during all intervals in play to do whatever is practicable to improve the bowler's foot holes.

10.3 Protection and preparation of adjacent pitches during matches

The protection (by way of an appropriate cover) and preparation of pitches which are adjacent to the match pitch will be permitted during the match subject to the following:

- i) Such measures will only be possible if requested by the ground curator and approved by the umpires before the start of the match.
- ii) Approval should only be granted where such measures are unavoidable and will not compromise the safety of the players or their ability to execute their actions with complete freedom.
- iii) The preparation work shall be carried out under the supervision of the fourth umpire.
- iv) Any necessary watering shall be carried out only to the extent necessary for such preparations and shall not be permitted in circumstances which may in any way affect the match pitch.
- v) The consent of the captains is not required but the umpires shall advise both captains and the ICC Match Referee before the start of the match on what has been agreed.

11 LAW 11 - COVERING THE PITCH

11.1 Law 11.1 - Before the match

The following shall apply in addition to Law 11.1:

The pitch shall be entirely protected against rain up to commencement of play.

11.2 Law 11.2 - During the match

Law 11.2 shall be replaced by the following:

The pitch shall be entirely protected against rain up to the commencement of play and for the duration of the period of the match.

The covers must totally protect the pitch and also the pitch surroundings, a minimum 5 metres either side of the pitch and any worn or soft areas in the outfield.

11.3 Law 11.3 - Covering bowlers' run ups

Law 11.3 shall be replaced by the following:

The bowlers' run-ups shall be covered in inclement weather, in order to keep them dry, to a distance of at least 10 x 10 metres.

11.4 Law 11.4 - Removal of covers

Law 11.4 shall be replaced by the following:

All covers (including "hessian" or "scrim" covers used to protect the pitch against the sun) shall be removed not later than 2½ hours before the scheduled start of play provided it is not raining at the time, but the pitch will be covered again if rain falls prior to the commencement of play.

Attention is drawn to clauses 3.5 and 10.3 above.

12 LAW 12 - INNINGS

Law 12 shall apply subject to the following (see also clauses 15 and 16 below):

12.1 Law 12.1 - Number of innings

Law 12.1 shall be replaced by the following:

All matches will consist of one innings per side, each innings being limited to a maximum of 20 overs. All matches shall be of one day's scheduled duration.

12.2 Law 12.2 - Alternate innings

Law 12.2 shall not apply.

12.3 Law 12.3 - Completed innings

Laws 12.3 (c), (d) and (e) (iii) shall not apply.

12.4 Length of Innings

12.4.1 Uninterrupted Matches.

- a) Each team shall bat for 20 overs unless all out earlier.
- b) If the team fielding first fails to bowl the required number of overs by the scheduled time for cessation of the first innings, play shall continue until the required number of overs has been bowled. The interval shall not be extended and the second session shall commence at the schedule time. The team batting second shall receive its full quota of 20 overs irrespective of the number of overs it bowled in the scheduled time for the cessation of the first innings.

- c) If the team batting first is dismissed in less than 20 overs, the team batting second shall be entitled to bat for 20 overs.
- d) If the team fielding second fails to bowl 20 overs by the scheduled cessation time, the hours of play shall be extended until the required number of overs has been bowled or a result is achieved.
- e) Penalties shall apply for slow over rates (refer ICC Code of Conduct).

12.4.2 Delayed or Interrupted Matches

- a) Delay or Interruption to the Innings of the Team Batting First (see Appendix 2)
 - i) When playing time has been lost the revised number of overs to be bowled in the match shall be based on a rate of 15 overs per hour in the total remaining time available for play.
 - ii) The revision of the number of overs should ensure, whenever possible, that both teams have the opportunity of batting for the same number of overs. The team batting second shall not bat for a greater number of overs than the first team unless the latter completed its innings in less than its allocated overs. To constitute a match, a minimum of 5 overs have to be bowled to the side batting second, subject to a result not being achieved earlier.
 - iii) As soon as the total minutes of playing time remaining is less than the completed overs faced by Team 1 multiplied by 4, then the first innings is terminated and the provisions of 12.4.2 b) below take effect.
 - iv) A fixed time will be specified for the commencement of the interval, and also the close of play for the match, by applying a rate of 15 overs per hour. When calculating the length of playing time available for the match, or the length of either innings, the timing and duration of all relative delays, extensions in playing hours, interruptions in play, and the interval will be taken into consideration. This calculation must not cause the match to finish earlier than the original or rescheduled time for cessation of play on the final scheduled day for play. If required the original time shall be extended to allow for one extra over for each team.
 - v) If the team fielding first fails to bowl the revised number of overs by the specified time, play shall continue until the required number of overs have been bowled or the innings is completed.
 - vi) Penalties shall apply for slow over rates (refer to ICC Code of Conduct).
- b) Delay or Interruption to the innings of the Team Batting Second (see Appendix 3)
 - i) When playing time has been lost and, as a result, it is not possible for the team batting second to have the opportunity of receiving its allocated, or revised allocation of overs in the playing time available, the number of overs shall be reduced at a rate of 15 overs per hour in respect of the lost playing time. Should the calculations result in a fraction of an over the fraction shall be ignored.

- ii) In addition, should the innings of the team batting first have been completed prior to the scheduled, or re-scheduled time for the commencement of the interval, then any calculation relating to the revision of overs shall not be effective until an amount of time equivalent to that by which the second innings started early has elapsed.
- iii) To constitute a match, a minimum of 5 overs have to be bowled to the team batting second subject to a result not being achieved earlier.
- iv) The team batting second shall not bat for a greater number of overs than the first team unless the latter completed its innings in less than its allocated overs.
- v) A fixed time will be specified for the close of play by applying a rate of 15 overs per hour. The timing and duration of all relative delays, extensions in playing hours and interruptions in play, will be taken into consideration in specifying this time.
- vi) If the team fielding second fails to bowl the revised overs by the scheduled or re-scheduled close of play, the hours of play shall be extended until the overs have been bowled or a result achieved.
- vii) Penalties shall apply for slow over rates (refer ICC Code of Conduct).

12.5 Extra Time

The participating countries may agree to provide for extra time where the start of play is delayed or play is suspended.

12.6 Number of Overs per Bowler

No bowler shall bowl more than 4 overs in an innings.

In a delayed or interrupted match where the overs are reduced for both teams or for the team bowling second, no bowler may bowl more than one-fifth of the total overs allowed.

Where the total overs is not divisible by 5, one additional over shall be allowed to the maximum number per bowler necessary to make up the balance.

In the event of a bowler breaking down and being unable to complete an over, the remaining balls will be allowed by another bowler. Such part of an over will count as a full over only in so far as each bowler's limit is concerned.

The scoreboard shall show the total number of overs bowled and the number of overs bowled by each bowler.

12.7 Law 12.4 – The toss

Law 12.4 shall be replaced by the following:

The captains shall toss for the choice of innings, on the field of play and in the presence of the ICC Match Referee, who shall supervise the toss. The toss shall take place not earlier than 30 minutes, nor later than 15 minutes before the scheduled or any re-scheduled time for the match to start. Note, however, the provisions of Law 1.3 (Captain).

Note: Law 12.5 requiring the captain of the side winning the toss to notify the opposing captain as soon as the toss is completed of his decision to bat or to field first shall apply.

13 LAW 13 - THE FOLLOW-ON

Law 13 shall not apply.

14 LAW 14 - DECLARATION AND FORFEITURE

Law 14 shall not apply.

15 LAW 15 - INTERVALS

Law 15 shall apply subject to the following:

15.1 Law 15.5 - Changing agreed times for intervals - Interval between Innings

If the innings of the team batting first is completed prior to the scheduled time for the interval, the interval shall take place immediately and the innings of the team batting second will commence correspondingly earlier. In circumstances where the side bowling first has not completed the allotted number of overs by the scheduled or re-scheduled cessation time for the first innings, the umpires shall reduce the length of the interval by the amount of time that the first innings over-ran. The minimum time for the interval will be 10 minutes.

However, following a lengthy delay or interruption prior to the completion of the innings of the team batting first, the Match Referee may, at his discretion, reduce the interval between innings from 20 minutes to not less than 10 minutes.

Such discretion should only be exercised after determining the adjusted overs per side based on a 20 minute interval. If having exercised this discretion, the rescheduled finishing time for the match is earlier than the latest possible finishing time, then these minutes should be deducted from the length of any interruption during the second innings before determining the overs remaining.

15.2 Law 15.9 - Intervals for drinks

No drinks intervals shall be permitted.

An individual player may be given a drink either on the boundary edge or at the fall of a wicket, on the field, provided that no playing time is wasted. No other drinks shall be taken onto the field without the permission of the umpires. Any player taking drinks onto the field shall be dressed in proper cricket attire (subject to the wearing of bibs – refer to the note in clause 2.2.3).

16 LAW 16 - START OF PLAY; CESSATION OF PLAY

Law 16 shall apply subject to the following (see also clauses 15 and 12.4):

16.1 Law 16.1 – Start and Cessation Times

To be determined by the Home Board subject to there being 2 sessions of 1 hour 20 minutes each, separated by a 20 minute interval between innings.

16.2 Minimum Over Rates

The minimum over rate to be achieved in a T20I match will be 15 overs per hour.

The actual over rate will be calculated at the end of the match by the umpires.

In calculating the actual over rate for the match, allowances will be given for the actual time lost as a result of any of the following:

- a) treatment given to a player by an authorised medical personnel on the field of play;
- b) a player being required to leave the field as a result of a serious injury;
- c) all third umpire referrals and consultations;
- d) time wasting by the batting side; and
- e) all other circumstances that are beyond the control of the fielding side.

In the event of any time allowances being granted to the fielding team under 16.2 (d) above (time wasting by batting team), then such time shall be deducted from the allowances granted to such batting team in the determination of its over rate.

In addition to the allowances as provided for above,

- in the case of an innings that has been reduced due to any delay or interruption in play, an additional allowance of 1 minute for every full 3 overs by which the innings is reduced will be granted.
- an additional allowance of 1 minute will be given for each of the 6th, 7th, 8th and 9th wickets taken during an innings.

If a side is bowled out within the time determined for that innings pursuant to these playing conditions (taking into account all of the time allowances set out above), the fielding side will be deemed to have complied with the required minimum over rate.

17 LAW 17 - PRACTICE ON THE FIELD

Law 17 shall apply subject to the following:

17.1 Law 17.1 - Practice on the pitch or the rest of the square

Law 17.1 shall apply subject to the following:

- a) The use of the square for practice on any day of any match will be restricted to any netted practice area or bowling strips specifically prepared on the edge of the square for that purpose.
- b) Bowling practice on the bowling strips referred to in (a) above shall also be permitted during the interval (and change of innings if not the interval) unless the umpires consider that, in the prevailing conditions of ground and weather, it will be detrimental to the surface of the square.

17.2 Law 17.3 - Practice on the outfield between the call of play and the call of time

Law 17.3 shall apply save that Law 17.3 (c) shall be replaced with the following:

- c) There shall be no bowling or batting practice on the outfield. Bowling a ball, using a short run up to a player in the outfield is not to be regarded as bowling practice but shall be subject to the law.

18 LAW 18 - SCORING RUNS

Law 18 shall apply.

19 LAW 19 - BOUNDARIES

Law 19 shall apply subject to the following:

19.1 Law 19.1 - The boundaries of the field of play

The following shall apply in addition to Law 19.1:

The playing area shall be a minimum of 150 yards (137.16 metres) from boundary to boundary square of the pitch, with the shorter of the two square boundaries being a minimum 65 yards (59.43 metres). The straight boundary at both ends of the pitch shall be a minimum of 70 yards (64.00 metres). Distances shall be measured from the centre of the pitch to be used.

In all cases the aim shall be to provide the largest playing area, subject to no boundary exceeding 90 yards (82.29 meters) from the centre of the pitch to be used.

Any ground which has been approved to host international cricket prior to 1st October 2007 or which is currently under construction as of this date which is unable to conform to these new minimum dimensions shall be exempt. In such cases the regulations in force immediately prior to the adoption of these regulations shall apply.

19.2 Law 19.2 - Defining the boundary - boundary marking

The following shall apply in addition to Law 19.2:

All boundaries must be designated by a rope or similar object of a minimum standard as authorised by the ICC from time to time. Where appropriate the rope should be a required minimum distance (3 yards (2.74 metres) minimum) inside the perimeter fencing or advertising signs. For grounds with a large playing area, the maximum length of boundary should be used before applying the minimum 3 yards (2.74 meters) between the boundary and the fence.

19.3 Law 19.3 - Scoring a boundary

The following shall apply in addition to Law 19.3:

If an unauthorized person enters the playing arena and handles the ball, the umpire at the bowler's end shall be the sole judge of whether the boundary allowance should be scored or the ball be treated as still in play or called dead ball if a batsman is liable to be out as a result of the unauthorized person handling the ball. See also Law 19.1 (c).

20 LAW 20 - LOST BALL

Law 20 shall apply.

21 LAW 21 - THE RESULT

Law 21 shall apply subject to the following:

21.1 Law 21.1 - A win - two innings match

Law 21.1 shall not apply.

21.2 Law 21.2 - A win - one innings match

Law 21.2 shall apply in addition to the following:

- 21.2.1 Save for circumstances where a match is awarded to a team as a consequence of the opposing team's refusal to play (Law 21.3), a result can be achieved only if both teams have had the opportunity of batting for at least 5 overs, unless one team has been all out in less than 5 overs or unless the team batting second scores enough runs to win in less than 5 overs.
- 21.2.2 Save for circumstances where a match is awarded to a team as a consequence of the opposing team's refusal to play (Law 21.3), all matches in which both teams have not had an opportunity of batting for a minimum of 5 overs, shall be declared no result.

21.3 Law 21.3 – Umpire (ICC Match Referee) awarding a match

Law 21.3 shall be replaced by the following:

- a) A match shall be lost by a side which either
 - i) concedes defeat or
 - ii) in the opinion of the ICC Match Referee refuses to play and the ICC Match Referee shall award the match to the other side.
- b) If an umpire considers that an action by any player or players might constitute a refusal by either side to play then the umpires together shall inform the ICC Match Referee of this fact. The ICC Match Referee shall together with the umpires ascertain the cause of the action. If the ICC Match Referee, after due consultation with the umpires, then decides that this action does constitute a refusal to play by one side, he shall so inform the captain of that side. If the captain persists in the action the ICC Match Referee shall award the match in accordance with (a)(ii) above.*
- c) If action as in (b) above takes place after play has started and does not constitute a refusal to play the delay or interruption in play shall be dealt with in the same manner as provided for in clause 12.4.2 above.

* N/B In addition to the consequences of any refusal to play prescribed under this clause, any such refusal, whether temporary or final, may result in disciplinary action being taken against the captain and team responsible under the Code of Conduct.

21.4 Law 21.4 – Matches in which there is an agreement under Law 12.1 (b)

Law 21.4 shall not apply.

21.5 Law 21.5 (a) - A Tie

The following shall apply in addition to Law 21.5 (a):

If the scores are equal, the result will be a tie and no account shall be taken of the number of wickets which have fallen. In the event of a tied match the teams shall compete in a Super Over to determine the winner. Refer attached Appendix 7.

21.6 Law 21.5 (b) - A Draw

Law 21.5 (b) shall not apply.

21.7 Interrupted or Prematurely Terminated Matches - Calculation of the Target Score

21.7.1 Interrupted Matches - Calculation of the Target Score

If, due to suspension of play after the start of the match, the number of overs in the innings of either team has to be revised to a lesser number than originally allotted (minimum of 5 overs), then a revised target score (to win) should be set for the number of overs which the team batting second will have the opportunity of facing. This revised target is to be calculated using the current Duckworth/Lewis method. The target set will always be a whole number and one run less will constitute a Tie. (Refer Duckworth/Lewis Regulations).

21.7.2 Prematurely Terminated Matches

If the innings of the side batting second is suspended (with at least 5 overs bowled) and it is not possible for the match to be resumed, the match will be decided by comparison with the D/L 'Par Score' determined at the instant of the suspension by the Duckworth/Lewis method (Refer Duckworth/Lewis Regulations). If the score is equal to the par score, the match is a Tie. Otherwise the result is a victory, or defeat, by the margin of runs by which the score exceeds, or falls short of, the Par Score.

21.8 Correctness of result

Any query on the result of the match as defined in Laws 21.2, 21.3, 21.5, 21.8 and 21.10 (as modified by these regulations) shall be resolved as soon as possible and a final decision made by the umpires at close of play.

22 LAW 22 - THE OVER

Law 22 shall apply subject to the addition of the following to Law 22.5:

22.1 Law 22.5 - Umpire miscounting

Whenever possible the third umpire shall liaise with the scorers and if possible inform the on-field umpires if the over has been miscounted.

23 LAW 23 - DEAD BALL

Law 23 shall apply subject to the addition of the following to Law 23.4.

23.1 Law 23.4 – Umpire calling and signalling 'Dead Ball'

In a match where cameras are being used on or over the field of play (e.g. Spydercam), should a ball that has been hit by the batsman make contact, while still in play, with the camera, its apparatus or its cable, either umpire shall call and signal 'dead ball'. The ball shall not count as one of the over and no runs shall be scored. If the delivery was called a no ball it shall count and the no ball penalty applied, including if appropriate a free hit from the next delivery. No other runs (including penalty runs) apart from the no ball penalty shall be scored.

Should a ball thrown by a fielder make contact with a camera on or over the field of play, its apparatus or its cable, either umpire shall call and signal dead ball. Unless this was already a no-ball or wide, the ball shall count as one of the over. All runs scored to that point shall count, plus the run in progress if the batsmen have already crossed.

24 LAW 24 - NO BALL

Law 24 shall apply subject to the following:

24.1 Law 24.1 (b) Mode of delivery

Law 24.1 (b) shall be replaced by the following:

The bowler may not deliver the ball underarm. If a bowler bowls a ball underarm the umpire shall call and signal no ball, and the ball is to be re-bowled overarm.

24.2 Free Hit after a foot-fault no ball

In addition to the above, the delivery following a no ball called for a foot fault (Law 24.5) shall be a free hit for whichever batsman is facing it. If the delivery for the free hit is not a legitimate delivery (any kind of no ball or a wide ball), then the next delivery will become a free hit for whichever batsman is facing it.

For any free hit, the striker can be dismissed only under the circumstances that apply for a no ball, even if the delivery for the free hit is called wide ball.

Field changes are not permitted for free hit deliveries unless there is a change of striker (the provisions of clause 41.2 shall apply).

The umpires will signal a free hit by (after the normal No Ball signal) extending one arm straight upwards and moving it in a circular motion.

24.3 Fair Delivery - the feet

Law 24.5 shall apply, subject to the final paragraph being replaced by the following:

If the bowler's end umpire is satisfied that any of these three conditions have not been met, he shall call and signal No ball.

25 LAW 25 - WIDE BALL

25.1 Law 25.1 - Judging a Wide

Law 25 shall apply with the following addition to Law 25.1:

Umpires are instructed to apply very strict and consistent interpretation in regard to this Law in order to prevent negative bowling wide of the wicket.

Any offside or legside delivery which in the opinion of the umpire does not give the batsman a reasonable opportunity to score shall be called a wide.

A penalty of one run for a wide shall be scored. This penalty shall stand in addition to any other runs which are scored or awarded. All runs, which are run or result from a wide ball, which is not a no ball, shall be scored wide balls.

26 LAW 26 - BYE AND LEG BYE

Law 26 shall apply.

27 LAW 27 - APPEALS

Law 27 shall apply.

28 LAW 28 - THE WICKET IS DOWN

Law 28 shall apply.

29 LAW 29 - BATSMAN OUT OF HIS GROUND

Law 29 shall apply.

30 LAW 30 - BOWLED

Law 30 shall apply.

31 LAW 31 - TIMED OUT

Law 31 will apply except that the incoming batsman must be in position to take guard or for his partner to be ready to receive the next ball within 1 minute 30 seconds of the fall of the previous wicket. The incoming batsman is expected to be ready to make his way to the wicket immediately a wicket falls.

Dugouts shall be provided.

32 LAW 32 - CAUGHT

Law 32 shall apply.

33 LAW 33 - HANDLED THE BALL

Law 33 shall apply.

34 LAW 34 - HIT THE BALL TWICE

Law 34 shall apply.

35 LAW 35 - HIT WICKET

Law 35 shall apply.

36 LAW 36 - LEG BEFORE WICKET

Law 36 shall apply.

37 LAW 37 - OBSTRUCTING THE FIELD

Law 37 shall apply. For the avoidance of doubt, if an umpire feels that a batsman, in running between the wickets, has significantly changed his direction without probable cause and thereby obstructed a fielder's attempt to effect a run out, the batsman should, on appeal, be given out, obstructing the field. It shall not be relevant whether a run out would have occurred or not.

If the change of direction involves the batsman crossing the pitch, Law 42.14 shall also apply.

38 LAW 38 - RUN OUT

Law 38 shall apply.

39 LAW 39 - STUMPED

Law 39 shall apply.

40 LAW 40 - THE WICKET-KEEPER

Law 40 shall apply.

41 LAW 41 – THE FIELDER

Law 41 shall apply subject to the following:

41.1 Law 41.1 - Protective equipment

The following shall apply in addition to Law 41.1:

The exchanging of protective equipment between members of the fielding side on the field shall be permitted provided that the umpires do not consider that it constitutes a waste of playing time.

41.2 Restrictions on the placement of fieldsmen

41.2.1 At the instant of delivery, there may not be more than 5 fieldsmen on the leg side.

41.2.2 In addition to the restriction contained in clause 41.2.1 above, further fielding restrictions shall apply to certain overs in each innings. The nature of such fielding restrictions and the overs during which they shall apply (hereinafter referred to as the Powerplay overs) are set out in the following paragraphs.

- a) Subject to 41.2.3 below these additional fielding restrictions shall apply to the first 6 overs of each innings (Powerplay overs).
- b) Two semi-circles shall be drawn on the field of play. The semi-circles shall have as their centre the middle stump at either end of the pitch. The radius of each of the semi-circles shall be 30 yards (27.43 metres). The semi-circles shall be linked by two parallel straight lines drawn on the field. (Refer attached Appendix 5). These fielding restriction areas should be marked by continuous painted white lines or 'dots' at 5 yard (4.57 metres) intervals, each 'dot' to be covered by a white plastic or rubber (but not metal) disc measuring 7 inches (18 cm) in diameter.
- c) During the Powerplay overs only two fieldsmen shall be permitted outside this fielding restriction area at the instant of delivery.
- d) During the non Powerplay overs, no more than 5 fieldsmen shall be permitted outside the fielding restriction area referred to in clause 41.2.2 (b) above.

41.2.3 In circumstances when the number of overs of the batting team is reduced, the number of Powerplay overs shall be reduced in accordance with the table below. For the sake of clarity, it should be noted that the table shall apply to both the 1st and 2nd innings of the match.

TOTAL OVERS IN INNINGS	NO. OF OVERS FOR WHICH FIELDING RESTRICTIONS IN CLAUSES 41.2.2 (a) & 41.2.2 (c) ABOVE WILL APPLY
5-8	2
9-11	3
12-14	4
15-18	5
19-20	6

41.2.4 If an innings is interrupted during an over and if on the resumption of play, due to the reduced number of overs of the batting team, the required number of Powerplay overs have already been bowled, the remaining deliveries in the over to be completed shall not be subject to the fielding restrictions.

- 41.2.5 In the event of an infringement of any of the above fielding restrictions, the square leg umpire shall call and signal 'No Ball'.

42 LAW 42 - FAIR AND UNFAIR PLAY

42.1 Law 42.3 - The Match Ball - changing its condition

Law 42.3 shall apply, subject to the following:

Law 42.3 (d) and (e) shall be replaced with the following:

If the umpires together agree that the deterioration of the ball is inconsistent with the use it has received, they shall consider that there has been a contravention of this Law. They shall then decide together whether they can identify the player(s) responsible for such conduct.

42.1.1 If it is possible to identify the player(s) responsible:

- a) Change the ball forthwith. The batsman at the wicket shall choose the replacement ball from a selection of six other balls of various degrees of usage (including a new ball) and of the same brand as the ball in use prior to the contravention.

Additionally the bowler's end umpire shall:

- b) Award 5 penalty runs to the batting side.
- c) Inform the captain of the fielding side of the reason for the action taken.
- d) Inform the captain of the batting side as soon as practicable of what has occurred.
- e) Together with the other umpire report the incident to the ICC Match Referee who shall take action as is appropriate against the player(s) responsible for the conduct under the ICC Code of Conduct.

42.1.2 If it is not possible to identify the player(s) responsible:

- a) Change the ball forthwith. The umpires shall choose the replacement ball for one of similar wear and of the same brand as the ball in use prior to the contravention.
- b) The bowler's end umpire shall issue the captain with a first and final warning, and
- c) Advise him that should there be any further incident by that team during the remainder of the match or series, steps 42.1.1 a) to e) above will be adopted, with the captain deemed under e) to be the player responsible.

42.2 Law 42.4 - Deliberate attempt to distract striker

Law 42.4 shall apply subject to the following:

In addition, the umpires shall report the incident to the ICC Match Referee under the ICC Code of Conduct.

42.3 Law 42.5 - Deliberate distraction or obstruction of batsman

Law 42.5 shall apply subject to the following:

In addition, the umpire shall report the incident to the ICC Match Referee under the ICC Code of Conduct.

42.4 Law 42.6 - Dangerous and Unfair Bowling**42.4.1 Law 42.6 (a) - The Bowling of Fast Short Pitched Balls**

Law 42.6 (a) shall be replaced by the following:

- a) A bowler shall be limited to one fast short-pitched delivery per over.
- b) A fast short-pitched delivery is defined as a ball which passes or would have passed above the shoulder height of the striker standing upright at the popping crease.
- c) The umpire at the bowler's end shall advise the bowler and the batsman on strike when each fast short pitched delivery has been bowled.
- d) In addition, for the purpose of this regulation and subject to Clause 42.4.1 (f) below, a ball that passes above head height of the batsman, that prevents him from being able to hit it with his bat by means of a normal cricket stroke shall be called a wide.
- e) For the avoidance of doubt any fast short pitched delivery that is called a wide under this playing condition shall also count as the allowable short pitched delivery in that over
- f) In the event of a bowler bowling more than one fast short-pitched delivery in an over as defined in Clause 42.4.1 (b) above, the umpire at the bowlers end shall call and signal no ball on each occasion. A differential signal shall be used to signify a fast short pitched delivery. The umpire shall call and signal 'no ball' and then tap the head with the other hand.
- g) If a bowler delivers a second fast short pitched ball in an over, the umpire, after the call of no ball and when the ball is dead, shall caution the bowler, inform the other umpire, the captain of the fielding side and the batsmen at the wicket of what has occurred. This caution shall apply throughout the innings.
- h) If there is a second instance of the bowler being no balled in the innings for bowling more than one fast short pitched delivery in an over, the umpire shall advise the bowler that this is his final warning for the innings.
- i) Should there be any further instance by the same bowler in that innings, the umpire shall call and signal no ball and when the ball is dead direct the captain to take the bowler off forthwith. If necessary, the over shall be completed by another bowler, who shall neither have bowled the previous over, or part thereof, nor be allowed to bowl the next over, or part thereof.
- j) The bowler thus taken off shall not be allowed to bowl again in that innings.
- k) The umpire will report the occurrence to the other umpire, the batsmen at the wicket and as soon as possible to the captain of the batting side.
- l) The umpires will then report the matter to the ICC Match Referee who shall take such action as is considered appropriate against the captain and the bowler concerned. (Refer also to Law 42.1 Fair and Unfair Play - Responsibility of the Captains.)

The above is not a substitute for Clause 42.5 below which umpires are able to apply at any time.

42.4.2 Law 42.6 (b) Bowling of High Full Pitched Balls

Law 42.6 (b) shall be replaced by the following:

- a) Any delivery which passes or would have passed on the full above waist height of the striker standing upright at the popping crease is deemed unfair, whether or not it is likely to inflict physical injury on the striker.
- b) In the event of a bowler bowling a high full pitched ball as defined in Clause 42.4.2 (a) above, the umpire at the bowler's end shall call and signal no ball.

If, in the opinion of the umpire, such a delivery is considered likely to inflict physical injury on the batsman, the umpire at the bowler's end shall, in addition to calling and signalling no ball, when the ball is dead, caution the bowler and issue a first and final warning. The umpire shall inform the other umpire, the captain of the fielding side and the batsmen at the wicket of what has occurred.

- c) Should there be any further instance (where a high full pitched ball is bowled and is considered likely to inflict physical injury on the batsman) by the same bowler in that innings, the umpire shall, in addition to calling and signalling no ball, when the ball is dead, direct the captain to take the bowler off forthwith. If necessary, the over shall be completed by another bowler, who shall neither have bowled the previous over, or part thereof, nor be allowed to bowl the next over, or part thereof.
- d) The bowler thus taken off shall not be allowed to bowl again in that innings.
- e) The umpire will report the occurrence to the other umpire, the batsman at the wicket and as soon as possible to the captain of the batting side.
- f) The umpires will then report the matter to the ICC Match Referee who shall take such action as is considered appropriate against the captain and the bowler concerned. (Refer also to Law 42.1 Fair and Unfair Play - Responsibility of the Captains.)

42.5 Law 42.7 - Dangerous and Unfair Bowling - Action by the umpire

Law 42.7 shall be replaced by the following:

Regardless of any action taken by the umpire as a result of a breach of Clauses 42.4.1, 42.4.2 and 42.6 the following shall apply at any time during the match:

42.5.1 The bowling of fast short pitched balls is unfair if in the opinion of the umpire at the bowler's end he considers that by their repetition and taking into account their length, height and direction, they are likely to inflict physical injury on the striker, irrespective of the protective clothing and equipment he may be wearing. The relative skill of the striker shall also be taken into consideration.

42.5.2 In the event of such unfair bowling, the umpire at the bowler's end shall adopt the following procedure:

- a) In the first instance the umpire shall call and signal no ball, caution the bowler and inform the other umpire, the captain of the fielding side and the batsmen of what has occurred.

- b) If this caution is ineffective, he shall repeat the above procedure and indicate to the bowler that this is a final warning.
- c) Both the above caution and final warning shall continue to apply even though the bowler may later change ends.
- d) Should there be any further instance by the same bowler in that innings, the umpire shall call and signal no ball and when the ball is dead direct the captain to take the bowler off forthwith. If necessary, the over shall be completed by another bowler, who shall neither have bowled the previous over, or part thereof, nor be allowed to bowl the next over, or part thereof. See Law 22.8. (Bowler Incapacitated or Suspended during an Over).
- e) The bowler thus taken off shall not be able to bowl again in that innings.
- f) The umpire will report the occurrence to the other umpire, the batsmen at the wicket and as soon as possible to the captain of the batting side.
- g) The umpires will then report the matter to the ICC Match Referee who shall take such action as is considered appropriate against the captain and the bowler concerned. (Refer also to Law 42.1 Fair and Unfair Play - Responsibility of the Captains.)

42.6 Law 42.8 - Deliberate bowling of High Full Pitched Balls

Law 42.8 shall be replaced by the following:

If the umpire considers that a high full pitch delivery which is deemed unfair as defined in Clause 42.4.2 was deliberately bowled, then the caution and warning process shall be dispensed with.

The umpire at the bowler's end shall:

- 42.6.1 Call and signal no ball.
- 42.6.2 When the ball is dead, direct the captain to take the bowler off forthwith.
- 42.6.3 Not allow the bowler to bowl again in that innings.
- 42.6.4 Ensure that the over is completed by another bowler, provided that the bowler does not bowl two overs or part thereof consecutively.
- 42.6.5 Report the occurrence to the other umpire, to the captain of the batting side and the ICC Match Referee who shall take such action as is considered appropriate against the captain and the bowler concerned. (Refer also to Law 42.1 Fair and Unfair Play Responsibility of the Captains).

42.7 Action by the umpires for dangerous and unfair Bowling

Should the umpires initiate the caution and warning procedures set out in Clauses 42.4.1, 42.4.2, 42.5 and 42.6 such cautions and warnings are not to be cumulative.

42.8 Law 42.9 - Time Wasting by the Fielding Side

Law 42.9 shall apply subject to Law 42.9 (c) being replaced by the following:

If there is any further waste of time in that innings, by any member of the fielding side the umpire shall:

- a) Call and signal dead ball if necessary, and;
- b) Award 5 penalty runs to the batting side (see Law 42.17).
- c) Inform the other umpire, the batsmen at the wicket and as soon as possible the captain of the batting side of what has occurred.
- d) Report the occurrence to the ICC Match Referee who shall take such action as is considered appropriate against the captain and the team concerned under the ICC Code of Conduct.

42.9 Law 42.10 - Batsman Wasting Time

Law 42.10 shall apply, subject to the following:

In addition, the umpires will report the incident to the ICC Match Referee under the ICC Code of Conduct.

42.10 Law 42.14 Batsman damaging the pitch

Law 42.14 shall apply, subject to the following:

See also clause 37 above.

42.11 Law 42.15 – Bowler attempting to run out non-striker before delivery

Law 42.15 shall be replaced by the following:

The bowler is permitted, before releasing the ball and provided he has not completed his usual delivery swing, to attempt to run out the non-striker. Whether the attempt is successful or not, the ball shall not count as one of the over. If the bowler fails in an attempt to run out the non-striker, the umpire shall call and signal Dead ball as soon possible.

42.12 Use of Electronic Communications Equipment

The use of electronic communication devices and equipment of any kind to communicate with players on the field of play shall not be permitted, except that broadcaster to player communication shall, with the prior consent of the participating countries, be allowed.

APPENDIX 1

All penalty runs in the Laws of Cricket (2000 Code 5th Edition - 2013) now apply in International Cricket. Some penalty runs can be referred to the ICC Match Referee for further action if necessary.

APPENDIX 2A

Calculation sheet for use when a delay or interruptions occur in the First Innings

Time

Net playing time available at start of the match	160 minutes	(A)
Time innings in progress	_____	(B)
Playing time lost	_____	(C)
Extra time available	_____	(D)
Time made up from reduced interval	_____	(E)
Effective playing time lost [C – (D + E)]	_____	(F)
Remaining playing time available [A - F]	_____	(G)
G divided by 4 (to 2 decimal places)	_____	(H)
Max overs per team [H/2] (round up fractions)	_____	(I)
Maximum overs per bowler [I / 5]	_____	
Number of Powerplay overs	_____	

Rescheduled Playing Hours

First session to commence or recommence	_____	(J)
Length of innings [I x 4]	_____	(K)
Rescheduled first innings cessation time [J + (K – B)]	_____	(L)
Length of interval	_____	(M)
Second innings commencement time [L + M]	_____	(N)
Rescheduled second innings cessation time [N + K]	_____	*(O)

* Ensure that the match is not finishing earlier than the original or rescheduled cessation time by applying Clause 12.4.2 a) iv). If so, add at least one over to each team and recalculate (I) to (O) above to prevent this from happening.

APPENDIX 2B

Calculation sheet to check whether an interruption during the First Innings should terminate the innings

Proposed re-start time	_____	(P)
Rescheduled cut-off time allowing for full use of any extra time provision	_____	(Q)
Minutes between P and Q	_____	(R)
Potential overs to be bowled [R / 4.2] (round up fractions)	_____	(S)
Number of complete overs faced to date in first innings	_____	(T)

If S is greater than T then revert to Appendix 2A

If S is less than or equal to T then the first innings is terminated and go to Appendix 3A

APPENDIX 3A

Calculation sheet for the start of the Second Innings

Maximum overs to be bowled:

(If first innings was terminated, S from Appendix 2B) _____ (A)

Scheduled length of innings: [$A \times 4$] _____ (B)

Start time _____ (C)

Scheduled cessation time [$C + B$] _____ (D)

Overs per bowler and Fielding Restrictions

Maximum overs per bowler [$A / 5$] _____

Number of Powerplay overs _____

APPENDIX 3B

Calculation sheet for use when interruption occurs after the start of the Second Innings

Time

Time at start of innings _____ (A)

Time at start of interruption _____ (B)

Time innings in progress _____ (C)

Restart time _____ (D)

Length of interruption [$D - B$] _____ (E)

Additional time available: (Any unused provision for 'Extra Time' or for earlier than scheduled start of second innings) _____ (F)

Total playing time lost [$E - F$] _____ (G)

Overs

Maximum overs at start of innings _____ (H)

Overs lost [$G / 4$] (rounded down) _____ (I)

Adjusted maximum length of innings [$H - I$] _____ (J)

Rescheduled length of innings [$J \times 4$] _____ (K)

Amended cessation time of innings [$D + (K - C)$] _____ (L)

Overs per bowler and Fielding Restrictions

Maximum overs per bowler [$J / 5$] _____

Number of Powerplay overs _____

APPENDIX 4 - CREASE MARKINGS

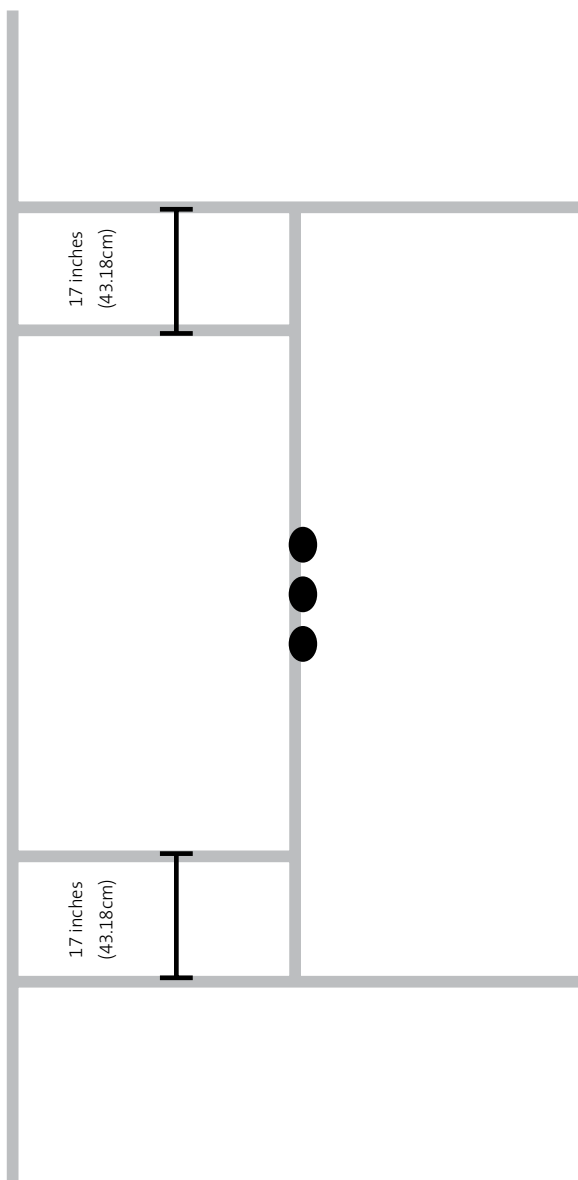

APPENDIX 5

Restriction of the placement of fieldsmen

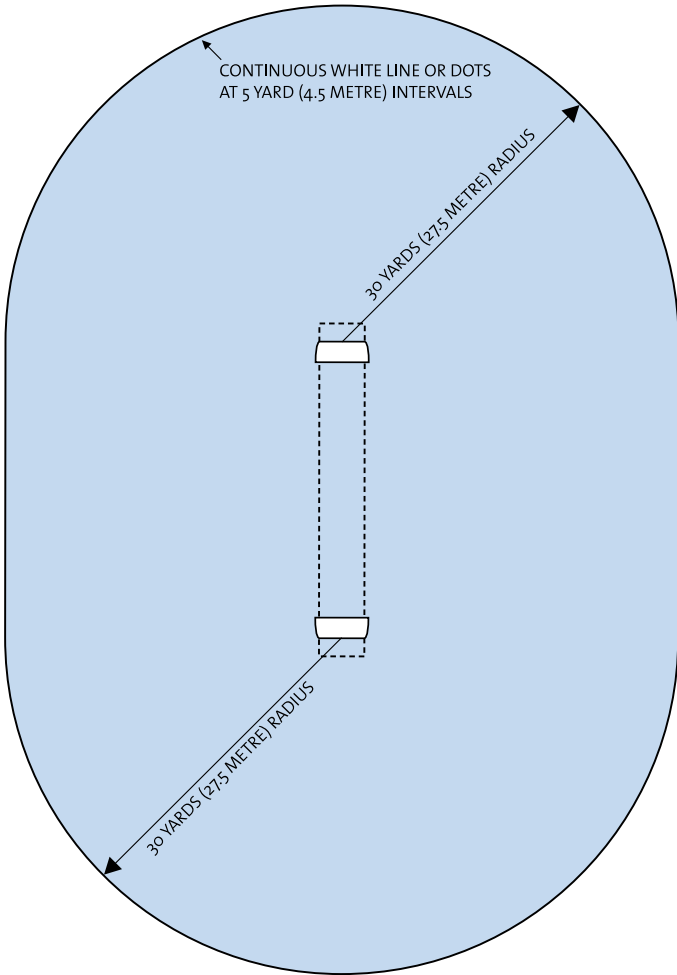

APPENDIX 6**Third Umpire TV Replay System – Playing Conditions****1 GENERAL**

- 1.1 Save with the express written consent of the Chief Executive Officer of the ICC the Home Board will ensure the live television broadcast of all T20I matches played in its country.
- 1.2 Where matches are broadcast the camera specification set out in Appendix 6A shall be mandatory as a minimum requirement.
- 1.3 Where matches are not broadcast the camera specifications set out in Appendix 6B shall be mandatory as a minimum requirement.
- 1.4 The Home Board will ensure a separate room is provided for the third umpire and that he has access to television monitors and direct sound link with the television control broadcast director to facilitate as many replays as is necessary to assist him in making a decision.
- 1.5 The provisions of clauses 1.1, 1.2, 1.3 and 1.4 above shall not apply for series between a Full Member country and Associate/Affiliate Member countries (whose matches have been granted ODI status) and for series between such Associate/Affiliate Member countries.
- 1.6 In the circumstances detailed in paragraphs 2, 3, 4, 5 and 6 below, the on-field umpire has the discretion whether to refer the decision to the third umpire or, in the case of paragraph 3, 1, 5 and 6, to consult with the third umpire before making his decision and should take a common sense approach.

Players may not appeal to the umpire to use the replay system - breach of this provision would constitute dissent and the player could be liable for discipline under the ICC Code of Conduct.
- 1.7 The third umpire shall call for as many replays from any camera angle as is necessary to reach a decision. As a guide, a decision should be made within 30 seconds whenever possible, but the third umpire shall have a discretion to take more time in order to finalise a decision.
- 1.8 The third umpire shall only have access to TV replays for the provisions of paragraphs 2, 3, 4, 5 and 6 below. Other technology which may be in use by the broadcaster for broadcast purposes (Hot Spot, ball tracking, Snicko) shall not be permitted.

2 RUN OUT, STUMPING AND HIT WICKET DECISIONS

- 2.1 The on-field umpire shall be entitled to refer an appeal for a run-out, stumping or hit wicket to the third umpire.
- 2.2 An on-field umpire wishing to refer a decision to the third umpire shall signal to the third umpire by making the shape of a TV screen with his hands.
- 2.3 If the third umpire decides the batsman is out a red light is displayed; a green light means not-out. Should the third umpire be temporarily unable to respond, a white light (where available) will remain illuminated throughout the period of interruption to signify to the on-field umpires that the TV replay system is temporarily unavailable, in which case the decision will be taken by the on-field umpire. (As an alternative to the red/green light system and where available, the big screen may be used for the purpose of conveying the third umpire's decision.)

- 2.4 When reviewing the TV replay(s), the third umpire shall first check the fairness of the delivery (foot fault, bowler breaking the wicket, waist high full tosses, bouncers above shoulder height). Additionally, if the third umpire finds the batsman is out by another mode of dismissal (excluding LBW), or not out by any mode of dismissal (excluding LBW), he shall notify the on-field umpire so that the correct decision is made.
- 2.5 Zing Wickets are permitted to be used for run-out, stumping and hit wicket decisions (using the lights to determine if the wicket is broken).

3 CAUGHT DECISIONS

The on-field umpire shall be entitled to refer an appeal for a caught decision to the third umpire in the following circumstances:

3.1 Clean Catches

- a) Should the bowler's end umpire be unable to decide whether or not a catch was taken cleanly, he shall first consult with the square leg umpire.
- b) Should both umpires be unable to make a decision, they may consult by two-way radio with the third umpire. Following such consultation, the final decision will be made and given by the bowler's end umpire, who will take into account the on-field umpires' initial views and any other advice received from the third umpire.
- c) The third umpire has to determine whether the batsman has been caught. However, when reviewing the television replay(s), the third umpire shall first check the fairness of the delivery (foot fault, bowler breaking the wicket, waist high full tosses, bouncers above shoulder height). Additionally, if it is clear to the third umpire that the batsman is out by another mode of dismissal (excluding LBW), or not out by any mode of dismissal (excluding LBW), he shall notify the on-field umpire so that the correct decision is made.
- d) The final decision shall be indicated in the normal fashion by the bowler's end umpire.

3.2 Bump Ball

- a) Should the bowler's end umpire be unable to decide whether a catch was taken from a bump ball or not, he shall first consult with the square leg umpire
- b) Should both on-field umpires be unable to make a decision, the bowler's end umpire shall be entitled to refer the decision to the third umpire to review a TV replay(s) of the batsman's stroke as in paragraph 2.2.
- c) The third umpire has to determine whether the ball was a bump ball or not. However, when reviewing the television replay(s), the third umpire shall first check the fairness of the delivery (foot fault and bowler breaking the wicket). Additionally, if it is clear to the third umpire that the batsman is out by another mode of dismissal (excluding LBW), or not out by any mode of dismissal (excluding LBW), he shall notify the on-field umpire so that the correct decision is made.
- d) The third umpire shall communicate his decision by the system as in paragraph 2.3.

4 BOUNDARY DECISIONS

- 4.1 The on-field umpire shall be entitled to refer to the third umpire for a decision about whether the fieldsman had any part of his person in contact with the ball when he touched the boundary or when he had any part of his person grounded beyond the boundary, or whether a four or six had been scored. A decision is to be made immediately and cannot be changed thereafter.
- 4.2 An on-field umpire wishing the assistance of the third umpire in this circumstance shall communicate with the third umpire by use of a two-way radio and the third umpire will convey his decision to the on-field umpire by this method.
- 4.3 The third umpire may initiate contact with the on-field umpire by two-way radio if TV coverage shows a boundary line infringement or incident that appears not to have been acted upon by the on-field umpires.

5 OBSTRUCTING THE FIELD

- a) Following an appeal from the fielding side, the on-field umpire shall be entitled to consult with the third umpire if he feels that the batsman, in running between the wickets, may have significantly changed his direction (refer clause 37).
- b) Such consultation shall be initiated by the on-field umpire and will be done to help him decide the extent of any change in direction and whether the obstruction was wilful or not.
- c) Following such consultation with the third umpire, the final decision shall be indicated in the normal fashion by the relevant on-field umpire.

6 BATSMEN RUNNING TO THE SAME END

- 6.1 In the event of both batsmen running to the same end and the umpires are uncertain over which batsman made his ground first, the on-field umpire may consult with the third umpire.
- 6.2 The procedure in paragraph 4.2 shall apply.

7 NO BALLS

Following any mode of dismissal that is not permitted off a no ball, if the on-field umpire is uncertain as the fairness of the delivery (foot-fault, bowler breaking the wicket, waist high full tosses, bouncers above shoulder height), he shall be entitled to request the batsman to delay leaving the field and to check the fairness of the delivery with the third umpire. Consultation with the third umpire shall be by way of two way radio. If the delivery was not a fair delivery the on-field umpire shall indicate that the batsman is not-out and signal no-ball. For the avoidance of doubt, the third umpire shall apply clause 24.3 when deciding whether a no-ball should have been called.

APPENDIX 6A

Generic Camera Layout - Basic TV Coverage

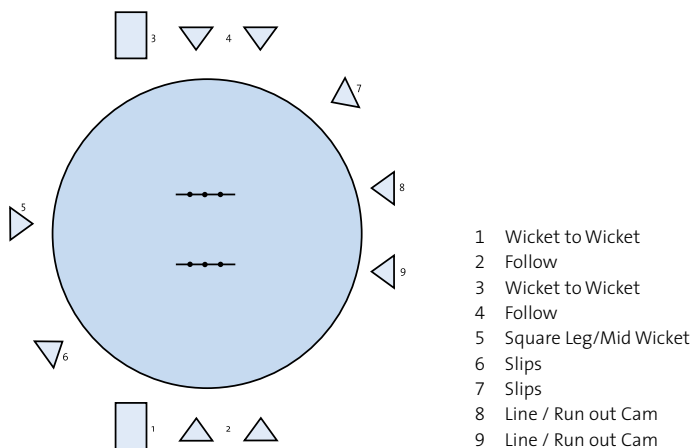

APPENDIX 6B

Generic Camera Layout - Third Umpire Coverage

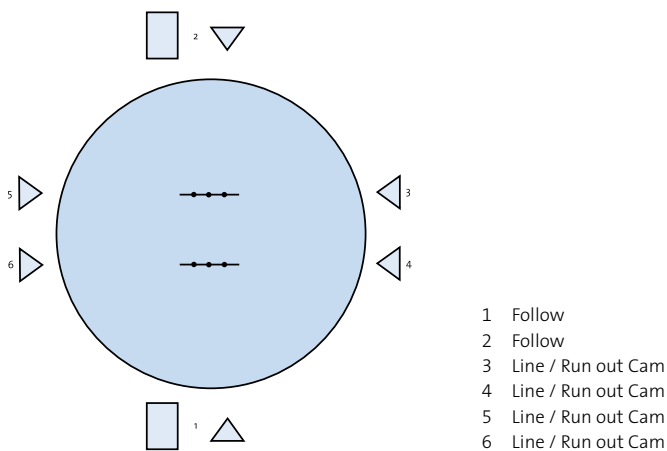

APPENDIX 7**Procedure for the Super Over**

The following procedure will apply should the provision for a Super Over be adopted in any match.

- 1 Subject to weather conditions the Super Over will take place on the scheduled day of the match at a time to be determined by the ICC Match Referee. In normal circumstances it shall commence 10 minutes after the conclusion of the match.
- 2 The amount of extra time allocated to the Super Over is the greater of (a) the extra time allocated to the original match less the amount of extra time actually utilised and (b) the gap between the actual end of the match and the time the original match would have been scheduled to finish had the whole of the extra time provision been utilised. Should play be delayed prior to or during the Super Over once the playing time lost exceeds the extra time allocated, the Super Over shall be abandoned. See clause 15.
- 3 The Super Over will take place on the pitch allocated for the match (the designated pitch) unless otherwise determined by the umpires in consultation with the ground authority and the ICC Match Referee.
- 4 The umpires shall stand at the same end as that in which they finished the match.
- 5 In both innings of the Super Over, the fielding side shall choose from which end to bowl.
- 6 Only nominated players in the main match may participate in the Super Over. Should any player (including the batsmen and bowler) be unable to continue to participate in the Super Over due to injury, illness or other wholly acceptable reasons, the relevant Laws and Playing Conditions as they apply in the main match shall also apply in the Super Over.
- 7 Any penance time being served in the main match shall be carried forward to the Super Over.
- 8 Each team's over is played with the same fielding restrictions as apply for the last over in a normal T20 International match.
- 9 The team batting second in the match will bat first in the Super Over.
- 10 The fielding captain or his nominee shall select the ball with which he wishes to bowl his over in the Super Over from the box of spare balls provided by the umpires. Such box to include the balls used in the main match, but no new balls. The team fielding first in the Super Over shall have first choice of ball. The team fielding second may choose to use the same ball as chosen by the team bowling first. If the ball needs to be changed, then playing conditions as stated for the main match shall apply.
- 11 The loss of two wickets in the over ends the team's one over innings.
- 12 In the event of the teams having the same score after the Super Over has been completed, if the original match was a tie under the D/L method, clause 14 immediately applies. Otherwise, the team whose batsmen hit the most number of boundaries combined from its two innings in both the main match and the Super Over shall be the winner.
- 13 If the number of boundaries hit by both teams is equal, the team whose batsmen scored more boundaries during its innings in the main match (ignoring the Super Over) shall be the winner.

- 14 If still equal, a count-back from the final ball of the Super Over shall be conducted. The team with the higher scoring delivery shall be the winner. If a team loses two wickets during its over, then any unbowled deliveries will be counted as dot balls. Note that for this purpose, the runs scored from a delivery is defined as the total team runs scored since the completion of the previous legitimate ball, i.e including any runs resulting from wides, no ball or penalty runs.

Example:

RUNS SCORED FROM:	TEAM 1	TEAM 2
Ball 6	1	1
Ball 5	4	4
Ball 4	2	1
Ball 3	6	2
Ball 2	0	1
Ball 1	2	6

In this example both teams scored an equal number of runs from the 6th and 5th ball of their innings. However team 1 scored 2 runs from its 4th ball while team 2 scored a single so team 1 is the winner.

- 15 Clause 2 examples:

Scheduled finish 5.00, 30 minutes extra time available, so scheduled finish time if the whole of the extra time provision is utilised is 5.30.

- No extra time is utilised in the original match which overruns ten minutes and finishes at 5.10. The Super Over is scheduled to start at 5.20 with 30 minutes extra time available. It starts on time but is interrupted at 5.25. Play must resume by 5.55 otherwise the Super Over is abandoned.
- 20 minutes of extra time was utilised, with the match scheduled to finish at 5.20, but it actually finishes at 5.10. Therefore the extra time allocated to the Super Over is the greater of a) 10 minutes (30 minutes extra time less 20 already utilised) and b) 20 minutes (the gap from the actual finish time of 5.10 and the scheduled finish had the full extra time been utilised of 5.30). The Super Over was due to start at 5.20, but is delayed by rain. It must therefore start by 5.40 or the Super Over is abandoned.
- The match finishes at 5.40 (having started 30 minutes late and overrun by 10 minutes). There is no extra time allocated to the Super Over which should start at 5.50. Any delay or interruption after 5.50 means the Super Over is abandoned.

DUCKWORTH-LEWIS METHOD OF RE-CALCULATING THE TARGET SCORE IN AN INTERRUPTED MATCH

DUCKWORTH-LEWIS METHOD OF RE-CALCULATING THE TARGET SCORE IN AN INTERRUPTED MATCH

The Professional Edition of the Duckworth-Lewis method shall be used in all matches. If any match is suspended after it has started such that the number of overs available to be faced by either side is reduced from that determined when the match started, the revised target shall be computed using the latest version of the 'ICC Duckworth/Lewis Calculator' as distributed by ICC in accordance with the instructions provided with that software.

Where possible, arrangements shall be made for the provision of back-up capability, in case of computer malfunction, for the operation or continued operation of the Professional Edition. In the event of computer non-availability or malfunction where no such provision has been made, the Standard Edition (the method in use prior to October 2003) shall be used.

The regulations given below describe only the operation of the Standard Edition, except that Clauses 4, 6 and 7 are also applicable to the Professional Edition.

1 INTRODUCTION

The D-L method sets revised targets in rain-interrupted limited-overs matches in accordance with the relative run scoring resources which are at the disposal of the two sides.

These are not in direct proportion to the number of overs available to be faced, as with the average run rate method of correction. Instead they depend on how many overs are to go and how many wickets are down when the interruptions occur.

To calculate the revised targets, you need to know the resources available at the stage of the match when suspensions and resumption of play occur. All possible values of resources have been pre-calculated and these are listed in the accompanying table.

The table covers each individual ball in a game of up to 50-overs per side. The figures given in the table are percentages of the resources available for a complete 50-over innings.

For matches with less than 50-overs per innings before they start, the resource percentages available at the start of an innings will be less than 100%. But the same table and the same method of calculation are used whatever the number of overs per innings.

The single sheet over-by-over version of the table can be used for cases when play is suspended before the start of a new over.

When Team 2 (the side batting second) have less run scoring resources at their disposal than had Team 1 (the side batting first), their target is adjusted downwards using the ratio of the resources available to the two sides.

But when Team 1's innings has been interrupted, it often happens that Team 2 have more resources at their disposal than had Team 1 and it is now necessary to adjust Team 2's target upwards. In this case the adjustment is based on the runs that would be expected to be scored on average from the extra resources at their disposal. The number of these extra runs required is calculated by applying the excess resource percentage to the average total score in a 50-over innings, referred to here as **G50**.

For matches involving ICC full member nations, or for matches between teams that play first class cricket, the value of **G50** should be 245.

For lower levels of the game:

- under 19 international matches
- under 15 international matches
- women's international matches
- matches between associate ICC member nations

the value of **G50** should be 200.

2 DEFINITIONS

- The team batting first are referred to as 'Team 1' and the team batting second are referred to as 'Team 2'.
- In the table decimal fractions of an over are expressed in standard cricket notation; i.e. 4.3 overs means 4 overs plus 3 balls.
- The terms 'target' and 'revised target' are reserved exclusively for the minimum score Team 2 need to win.
- As with an uninterrupted match, if Team 2 make a score which is one run short of the target, the match is tied.

The following symbols are used throughout:

N is the number of overs per innings for the match as decided at the moment of delivery of the first ball of the match.

S is Team 1's total score.

R1 is the resource percentage (relative to a full 50-over innings) available to Team 1.

R2 is the resource percentage (relative to a full 50-over innings) available to Team 2.

T is Team 2's target score.

3 CALCULATION OF THE PERCENTAGE RESOURCE LOST BY A SUSPENSION IN PLAY

To compensate for any loss of overs due to a suspension in play during either Team 1's or Team 2's innings, it is necessary first to calculate the resource percentage that has been lost on account of this suspension.

If the suspension occurs between overs, use the sheet of the table which gives the figures for whole numbers of overs. If it occurs mid-over, use the sheets of the table which provide the figures for each individual ball.

- 3.1 For the start of the suspension in play, from the table note the resource percentage that remained for the appropriate number of overs/balls left and wickets lost.
- 3.2 For the resumption of play after the suspension, from the table note the resource percentage now remaining for the revised number of overs/balls left and for the same number of wickets lost.
- 3.3 Subtract the resource percentage in 3.2 from that in 3.1 to give the resource percentage lost.
- 3.4 If a suspension in play causes the innings to be terminated, the resource percentage on resumption (3.2) is zero and the percentage lost is the resource percentage which was remaining when the suspension occurred (3.1).

- 3.5 If more than one suspension in play occurs, the resource percentages lost are calculated as described in 3.1 to 3.4 and are accumulated to give updated values for the total resource percentage lost or resource available for the innings. This is done after each suspension as described in 5.2 and 5.5.

4 PENALTIES FOR SLOW OVER RATES

No overs penalties are imposed for slow over rates and hence slow over rates have no effect on revised target calculations.

5 CALCULATION OF REVISED TARGETS

- 5.1 Note the number of overs per innings decided at the start of the game, **N**. From the table note the resource percentage available to Team 1 at the start of their innings.
(For N = 50 this is 100%).
- 5.2 For all suspensions and any premature termination of Team 1's innings, calculate the total resource percentage lost using the procedure described in section 3. Subtract this from the starting resource percentage (5.1) to give **R₁**, the resource which was available to Team 1 for their innings. Note Team 1's total score, **S**.
- 5.3 There is no overs penalty for slow over rates by either side.
- 5.4 Note the number of overs allocated to Team 2 at the start of their innings and from the table note the resource percentage for this number of overs remaining and 0 wicket lost. This is **R₂**, the resource percentage available to Team 2. If **R₂** differs from **R₁**, which will happen if Team 1's innings was interrupted and/or Team 2's was delayed, a revised target must be set. Calculate this revised target, **T**, as described in 5.6 below.
- 5.5 For each suspension of play during Team 2's innings or for premature termination of the match, update the resource percentage available, **R₂**, by subtracting the resource percentage lost calculated as in section 3. Calculate the revised target, **T**, after each suspension as described in 5.6 below. If the match has to be terminated, the result is decided by comparing Team 2's score at the time with the 'par score', this being the value as calculated in the formulae for **T** in 5.6 below, but without the one run added.
If it is greater, Team 2 win. If it is equal, the match is tied. If it is less, Team 1 win.
- 5.6 If **R₂** is less than **R₁**, Team 2's revised target is obtained by reducing Team 1's score **S** in the ratio of **R₂** to **R₁**, ignoring any figures after the decimal point, and adding one run
i.e. $T = (S \times R_2/R_1) + 1$ (rounded down to a whole number, if necessary).
If **R₂** is equal to **R₁**, no revision is needed and Team 2's target is one more run than Team 1's score.
i.e. $T = S + 1$
If **R₂** is greater than **R₁**, calculate the amount of excess resources, **R₂ - R₁**, and take this percentage of the average 50-over total, **G₅₀**, to give the extra runs needed, ignoring any figures after the decimal point.
i.e. $T = S + (R_2 - R_1) \times G_{50}/100 + 1$ (rounded down to a whole number, if necessary)

6 PENALTY RUNS

6.1 During Team 1's innings

If penalty runs are awarded to the batting side, then their score shall advance accordingly and be taken into account when performing any future D/L calculation.

If penalty runs are awarded to the fielding side, then any D/L calculation in between innings will be performed as normal, and their innings will commence with the score equivalent to the number of penalty runs that they have been awarded.

6.2 During Team 2's innings

If penalty runs are awarded to the batting side, then their score shall advance accordingly. These penalty runs do not affect any subsequent D/L calculation.

If penalty runs are awarded to the fielding side, then there will be no recalculation of any D/L target. Instead, the target score and the entire schedule of par scores will advance by the appropriate number of penalty runs. If a loss of overs occurs after such a penalty has been awarded, then the D/L target will be calculated based upon the original score of the side batting first, and this target, and all par scores, will then be raised by the appropriate number of penalty runs.

7 THE RESULT AND ITS DESCRIPTION

When a revised target has been calculated and the match has been played out to its completion, the result is described exactly as in the case of an uninterrupted match; if Team 2 achieve their revised target they win by the number of wickets they have in hand when they reach this score; if they fall short of their revised target by exactly one run the result is a tie, and if they make a lower score Team 1 win by the margin of runs by which Team 2 fall short of the score needed to achieve a tie.

When a match has to be abandoned with Team 2's innings in progress (provided sufficient overs have been bowled to constitute a viable match), the result is decided by comparing Team 2's score with the 'par score' as defined in 5.5 and the winning margin is described in terms of the number of runs by which their score differs from the 'par score', regardless of whether Team 1 or Team 2 are the victors.

Whenever a completed game has involved the use of the D/L method, the description should be qualified by appending '(D/L method)'.

7.1 Examples of result description:

- i Team 2 are set a revised target of 186. But they only succeed in making 180 in their allocation of overs. They thus fall 5 runs short of the 185 runs needed to tie the match and the result is described as 'Team 1 win by 5 runs (D/L method)'.
- ii Team 2 are chasing a target of 201 in a 50-over per innings match and reach 105/4 after 25 overs when rain causes the match to be abandoned. At this point the 'par score' is 100. Team 2 have exceeded this by 5 runs and so the result is described as 'Team 2 win by 5 runs (D/L method)'.

Example 1 (Suspension during Team 1's innings)

In a 50 over-per-innings match, Team 1 reaches 79/3 after 20 overs and then there is a suspension in play. It is decided that 20 overs of the match should be lost, 10 of these by each team. Team 1 resumes to reach a final total of 180 in its revised allocation of 40 overs.

Number of overs per innings at the start of match, $N = 50$

Resource percentage available to Team 1 at start of innings = 100% (5.1)

Resource percentage remaining at suspension (30 overs left, 3 wkts lost) = 61.6% (3.1)

Resource percentage remaining at resumption (20 overs left, 3 wkts lost) = 49.1% (3.2)

Resource percentage lost due to suspension = $61.6 - 49.1 = 12.5\%$ (3.3)

Resource percentage available to Team 1, $R_1 = 100 - 12.5 = 87.5\%$ (5.2)

Number of overs available to Team 2 at the start of its innings = 40

Resource percentage available (40 overs left, 0 wkt lost), $R_2 = 89.3\%$ (5.4)

R_2 is greater than R_1 , i.e. Team 2 has more resource available than had Team 1, so its target should be increased. $S = 180$

Team 2's revised target (5.6) is

$T = S + G50 \times (R_2 - R_1)/100 + 1 = 180 + 245 \times (89.3 - 87.5)/100 + 1 = 185$ (rounded down).

Example 2 (delay to start of Team 2's innings)

In a match in a competition which has 45 overs per innings, Team 1 scores 212 in its allocated 45 overs. Rain then causes Team 2's response to be delayed and it is decided that it should be shortened to 35 overs.

Number of overs at start of match, $N = 45$

Resource percentage available to Team 1 at start of its innings (45 overs left, 0 wkt lost) = 95.0% (5.1).

The innings was not interrupted, so $R_1 = 95.0\%$

Number of overs available to Team 2 at start of its innings = 35

Resource percentage available to Team 2 at start of innings (35 overs left, 0 wkt lost) $R_2 = 82.7\%$ (5.4)

R_2 is less than R_1 ; $S = 212$

Team 2's revised target (5.6) is

$T = S \times R_2/R_1 + 1 = 212 \times 82.7/95.0 + 1 = 185$ (rounded down).

Example 3 (suspension during Team 2's innings)

In an One Day International match (50 overs per innings), Team 1 has scored 250 from its allocation of 50 overs in an uninterrupted innings. Team 2 has received 12 overs and has scored 40/1. Then play is suspended and 10 overs are lost.

Number of overs at start of match, $N = 50$.

Team 1's innings was uninterrupted, so its resource percentage available, $R_1 = 100\%$ (5.1).

Resource percentage available to Team 2 at start of innings = 100% (5.4).

Resource percentage remaining at suspension (38 overs left, 1 wkt lost) = 82.0% (3.1).

Resource percentage remaining at resumption (28 overs left, 1 wkt lost) = 68.8% (3.2).

Resource percentage lost due to suspension = $82.0 - 68.8 = 13.2\%$ (3.3).

Resource percentage available to Team 2, $R_2 = 100 - 13.2 = 86.8\%$ (5.5).

R_2 is less than R_1 ; $S = 250$.

Team 2's revised target (5.6) is

$T = S \times R_2/R_1 + 1 = 250 \times 86.8/100 + 1 = 218$, and it needs a further 178 runs from 28 overs.

Example 4 (multiple suspensions and abandonment)

Suppose that in Example 3, play continues for a further 10 overs during which Team 2 takes its score on to 98/3, whereupon there is another suspension in play and 2 more overs are lost. A further 8.2 overs are bowled and Team 2 is 154/6 when rain washes out the match.

Team 1's resource percentage is still $R_1 = 100\%$.

Team 2's resource percentage has been reduced further.

Resource percentage remaining at start of second suspension (18 overs left, 3 wkts lost) = 45.9% (3.1).

Resource percentage remaining at end of second suspension (16 overs left, 3 wkts lost) = 42.3% (3.2).

Resource percentage lost due to second suspension = $45.9 - 42.3 = 3.6\%$ (3.3).

Resource percentage available to Team 2, $R_2 = 86.8 - 3.6 = 83.2\%$ (5.5).

R_2 is less than R_1 ; $S = 250$.

Team 2's revised target (5.6) is

$T = S \times R_2/R_1 + 1 = 250 \times 83.2/100 + 1 = 209$ and it needs a further 111 runs from 16 overs.

When the innings had to be terminated, there were 7.4 overs remaining.

Resource percentage remaining at termination of Team 2's innings (7.4 overs left, 6 wkts lost) = 19.4% .

This remaining resource is lost by the termination.

Resource percentage available to Team 2, $R_2 = 83.2 - 19.4 = 63.8\%$ (5.5).

R_2 is less than R_1 ; $S = 250$.

Team 2's par score (5.5 and 5.6) is $S \times R_2/R_1 = 250 \times 63.8/100 = 159$ (rounded down); the par score at the instant of abandonment is 159 and with a score of 154 it has lost by 5 runs.

Team 1 wins by 5 runs (D-L method) (7).

Example 5 (suspension and termination of Team 1's innings mid-over and delay to Team 2's innings)

This is taken from an actual ODI: India (Team 1) versus Pakistan (Team 2), Singapore, April 1996. Team 1 scores 226/8 in 47.1 of a scheduled 50 overs. Rain then terminates Team 1's innings and delays that of Team 2, which is given a reduced allocation of 33 overs.

Number of overs per innings at start of match, $N = 50$

Team 1's innings:

Resource percentage at start of innings is 100% (5.1).

Resource percentage remaining at termination (2.5 overs left, 8 wkts lost) = 6.9% (3.1).

Resource percentage lost due to termination = 6.9% (3.4).

Resource percentage available, $R_1 = 100 - 6.9 = 93.1\%$ (5.2).

Team 2's innings (allocated 33 overs):

Resource percentage available at start of innings (33 overs left, 0 wkts lost),

$R_2 = 79.8\%$ (5.4).

R_2 is less than R_1 ; $S = 226$.

Team 2's revised target (5.6) is

$T = S \times R_2 / R_1 + 1 = 226 \times 79.8 / 93.1 + 1 = 194$ (rounded down).

Example 6 (as Example 5 but with a further interruption during Team 2's innings)

In the match of the previous example, Team 2 has scored 140 for 2 after 25 overs when a further 5 overs are lost to the weather.

Team 1's resource percentage is still $R_1 = 93.1\%$.

Team 2's innings:

Resource percentage at start of innings (33 overs left, 0 wkt lost) = 79.8% (5.4).

Resource percentage remaining at suspension (8 overs left, 2 wkts lost) = 25.5% (3.1).

Resource percentage remaining at resumption (3 overs left, 2 wkts lost) = 10.4% (3.2).

Resource percentage lost due to suspension = 25.5 - 10.4 = 15.1% (3.3).

Resource percentage available, $R_2 = 79.8 - 15.1 = 64.7\%$ (5.2).

R_2 is less than R_1 ; $S = 226$.

Team 2's revised target (5.6) is

$T = S \times R_2 / R_1 + 1 = 226 \times 64.7 / 93.1 + 1 = 158$ (rounded down) and it needs a further 18 runs from 3 overs.

The D-L (Duckworth/Lewis) method of adjusting target scores in interrupted one-day cricket matches - Standard Edition

***Use only when Professional Edition is not available.**

Table of resource percentages remaining - over by over

Overs left 50 to 0

OVERS LEFT	WICKETS LOST										OVERS LEFT
	0	1	2	3	4	5	6	7	8	9	
50	100.0	93.4	85.1	74.9	62.7	49.0	34.9	22.0	11.9	4.7	50
49	99.1	92.6	84.5	74.4	62.5	48.9	34.9	22.0	11.9	4.7	49
48	98.1	91.7	83.8	74.0	62.2	48.8	34.9	22.0	11.9	4.7	48
47	97.1	90.9	83.2	73.5	61.9	48.6	34.9	22.0	11.9	4.7	47
46	96.1	90.0	82.5	73.0	61.6	48.5	34.8	22.0	11.9	4.7	46
45	95.0	89.1	81.8	72.5	61.3	48.4	34.8	22.0	11.9	4.7	45
44	93.9	88.2	81.0	72.0	61.0	48.3	34.8	22.0	11.9	4.7	44
43	92.8	87.3	80.3	71.4	60.7	48.1	34.7	22.0	11.9	4.7	43
42	91.7	86.3	79.5	70.9	60.3	47.9	34.7	22.0	11.9	4.7	42
41	90.5	85.3	78.7	70.3	59.9	47.8	34.6	22.0	11.9	4.7	41
40	89.3	84.2	77.8	69.6	59.5	47.6	34.6	22.0	11.9	4.7	40
39	88.0	83.1	76.9	69.0	59.1	47.4	34.5	22.0	11.9	4.7	39
38	86.7	82.0	76.0	68.3	58.7	47.1	34.5	21.9	11.9	4.7	38
37	85.4	80.9	75.0	67.6	58.2	46.9	34.4	21.9	11.9	4.7	37
36	84.1	79.7	74.1	66.8	57.7	46.6	34.3	21.9	11.9	4.7	36
35	82.7	78.5	73.0	66.0	57.2	46.4	34.2	21.9	11.9	4.7	35
34	81.3	77.2	72.0	65.2	56.6	46.1	34.1	21.9	11.9	4.7	34
33	79.8	75.9	70.9	64.4	56.0	45.8	34.0	21.9	11.9	4.7	33
32	78.3	74.6	69.7	63.5	55.4	45.4	33.9	21.9	11.9	4.7	32
31	76.7	73.2	68.6	62.5	54.8	45.1	33.7	21.9	11.9	4.7	31
30	75.1	71.8	67.3	61.6	54.1	44.7	33.6	21.8	11.9	4.7	30
29	73.5	70.3	66.1	60.5	53.4	44.2	33.4	21.8	11.9	4.7	29
28	71.8	68.8	64.8	59.5	52.6	43.8	33.2	21.8	11.9	4.7	28
27	70.1	67.2	63.4	58.4	51.8	43.3	33.0	21.7	11.9	4.7	27
26	68.3	65.6	62.0	57.2	50.9	42.8	32.8	21.7	11.9	4.7	26
25	66.5	63.9	60.5	56.0	50.0	42.2	32.6	21.6	11.9	4.7	25
24	64.6	62.2	59.0	54.7	49.0	41.6	32.3	21.6	11.9	4.7	24
23	62.7	60.4	57.4	53.4	48.0	40.9	32.0	21.5	11.9	4.7	23
22	60.7	58.6	55.8	52.0	47.0	40.2	31.6	21.4	11.9	4.7	22
21	58.7	56.7	54.1	50.6	45.8	39.4	31.2	21.3	11.9	4.7	21
20	56.6	54.8	52.4	49.1	44.6	38.6	30.8	21.2	11.9	4.7	20
19	54.4	52.8	50.5	47.5	43.4	37.7	30.3	21.1	11.9	4.7	19
18	52.2	50.7	48.6	45.9	42.0	36.8	29.8	20.9	11.9	4.7	18
17	49.9	48.5	46.7	44.1	40.6	35.8	29.2	20.7	11.9	4.7	17
16	47.6	46.3	44.7	42.3	39.1	34.7	28.5	20.5	11.8	4.7	16
15	45.2	44.1	42.6	40.5	37.6	33.5	27.8	20.2	11.8	4.7	15
14	42.7	41.7	40.4	38.5	35.9	32.2	27.0	19.9	11.8	4.7	14
13	40.2	39.3	38.1	36.5	34.2	30.8	26.1	19.5	11.7	4.7	13
12	37.6	36.8	35.8	34.3	32.3	29.4	25.1	19.0	11.6	4.7	12
11	34.9	34.2	33.4	32.1	30.4	27.8	24.0	18.5	11.5	4.7	11
10	32.1	31.6	30.8	29.8	28.3	26.1	22.8	17.9	11.4	4.7	10
9	29.3	28.9	28.2	27.4	26.1	24.2	21.4	17.1	11.2	4.7	9
8	26.4	26.0	25.5	24.8	23.8	22.3	19.9	16.2	10.9	4.7	8
7	23.4	23.1	22.7	22.2	21.4	20.1	18.2	15.2	10.5	4.7	7
6	20.3	20.1	19.8	19.4	18.8	17.8	16.4	13.9	10.1	4.6	6
5	17.2	17.0	16.8	16.5	16.1	15.4	14.3	12.5	9.4	4.6	5
4	13.9	13.8	13.7	13.5	13.2	12.7	12.0	10.7	8.4	4.5	4
3	10.6	10.5	10.4	10.3	10.2	9.9	9.5	8.7	7.2	4.2	3
2	7.2	7.1	7.1	7.0	7.0	6.8	6.6	6.2	5.5	3.7	2
1	3.6	3.6	3.6	3.6	3.6	3.5	3.5	3.4	3.2	2.5	1
0	0	0	0	0	0	0	0	0	0	0	0

The D-L (Duckworth-Lewis) method of adjusting target scores in interrupted one-day cricket matches - Standard Edition

*Use only when Professional Edition is not available.

Table of resource percentages remaining - ball by ball

Overs left 50 to 40

OVERS LEFT	WICKETS LOST									OVERS LEFT	
	0	1	2	3	4	5	6	7	8		9
50	100.0	93.4	85.1	74.9	62.7	49.0	34.9	22.0	11.9	4.7	50
49.5	99.8	93.2	85.0	74.8	62.7	49.0	34.9	22.0	11.9	4.7	49.5
49.4	99.7	93.1	84.9	74.7	62.6	48.9	34.9	22.0	11.9	4.7	49.4
49.3	99.5	93.0	84.8	74.6	62.6	48.9	34.9	22.0	11.9	4.7	49.3
49.2	99.4	92.8	84.7	74.6	62.5	48.9	34.9	22.0	11.9	4.7	49.2
49.1	99.2	92.7	84.6	74.5	62.5	48.9	34.9	22.0	11.9	4.7	49.1
49	99.1	92.6	84.5	74.4	62.5	48.9	34.9	22.0	11.9	4.7	49
48.5	98.9	92.4	84.4	74.4	62.4	48.9	34.9	22.0	11.9	4.7	48.5
48.4	98.7	92.3	84.3	74.3	62.4	48.8	34.9	22.0	11.9	4.7	48.4
48.3	98.6	92.2	84.2	74.2	62.3	48.8	34.9	22.0	11.9	4.7	48.3
48.2	98.4	92.0	84.0	74.1	62.3	48.8	34.9	22.0	11.9	4.7	48.2
48.1	98.2	91.9	83.9	74.1	62.2	48.8	34.9	22.0	11.9	4.7	48.1
48	98.1	91.7	83.8	74.0	62.2	48.8	34.9	22.0	11.9	4.7	48
47.5	97.9	91.6	83.7	73.9	62.2	48.7	34.9	22.0	11.9	4.7	47.5
47.4	97.8	91.5	83.6	73.8	62.1	48.7	34.9	22.0	11.9	4.7	47.4
47.3	97.6	91.3	83.5	73.8	62.1	48.7	34.9	22.0	11.9	4.7	47.3
47.2	97.4	91.2	83.4	73.7	62.0	48.7	34.9	22.0	11.9	4.7	47.2
47.1	97.3	91.0	83.3	73.6	62.0	48.7	34.9	22.0	11.9	4.7	47.1
47	97.1	90.9	83.2	73.5	61.9	48.6	34.9	22.0	11.9	4.7	47
46.5	96.9	90.8	83.1	73.4	61.9	48.6	34.9	22.0	11.9	4.7	46.5
46.4	96.7	90.6	82.9	73.4	61.8	48.6	34.9	22.0	11.9	4.7	46.4
46.3	96.6	90.5	82.8	73.3	61.8	48.6	34.8	22.0	11.9	4.7	46.3
46.2	96.4	90.3	82.7	73.2	61.7	48.6	34.8	22.0	11.9	4.7	46.2
46.1	96.2	90.2	82.6	73.1	61.7	48.5	34.8	22.0	11.9	4.7	46.1
46	96.1	90.0	82.5	73.0	61.6	48.5	34.8	22.0	11.9	4.7	46
45.5	95.9	89.9	82.4	73.0	61.6	48.5	34.8	22.0	11.9	4.7	45.5
45.4	95.7	89.7	82.3	72.9	61.5	48.5	34.8	22.0	11.9	4.7	45.4
45.3	95.5	89.6	82.1	72.8	61.5	48.5	34.8	22.0	11.9	4.7	45.3
45.2	95.4	89.4	82.0	72.7	61.4	48.4	34.8	22.0	11.9	4.7	45.2
45.1	95.2	89.3	81.9	72.6	61.4	48.4	34.8	22.0	11.9	4.7	45.1
45	95.0	89.1	81.8	72.5	61.3	48.4	34.8	22.0	11.9	4.7	45
44.5	94.8	89.0	81.7	72.4	61.3	48.4	34.8	22.0	11.9	4.7	44.5
44.4	94.6	88.8	81.5	72.4	61.2	48.3	34.8	22.0	11.9	4.7	44.4
44.3	94.5	88.7	81.4	72.3	61.2	48.3	34.8	22.0	11.9	4.7	44.3
44.2	94.3	88.5	81.3	72.2	61.1	48.3	34.8	22.0	11.9	4.7	44.2
44.1	94.1	88.4	81.2	72.1	61.1	48.3	34.8	22.0	11.9	4.7	44.1
44	93.9	88.2	81.0	72.0	61.0	48.3	34.8	22.0	11.9	4.7	44
43.5	93.7	88.1	80.9	71.9	61.0	48.2	34.8	22.0	11.9	4.7	43.5
43.4	93.5	87.9	80.8	71.8	60.9	48.2	34.8	22.0	11.9	4.7	43.4
43.3	93.4	87.7	80.7	71.7	60.8	48.2	34.7	22.0	11.9	4.7	43.3
43.2	93.2	87.6	80.5	71.6	60.8	48.1	34.7	22.0	11.9	4.7	43.2
43.1	93.0	87.4	80.4	71.5	60.7	48.1	34.7	22.0	11.9	4.7	43.1
43	92.8	87.3	80.3	71.4	60.7	48.1	34.7	22.0	11.9	4.7	43
42.5	92.6	87.1	80.1	71.3	60.6	48.1	34.7	22.0	11.9	4.7	42.5
42.4	92.4	86.9	80.0	71.3	60.6	48.0	34.7	22.0	11.9	4.7	42.4
42.3	92.2	86.8	79.9	71.2	60.5	48.0	34.7	22.0	11.9	4.7	42.3
42.2	92.0	86.6	79.7	71.1	60.4	48.0	34.7	22.0	11.9	4.7	42.2
42.1	91.8	86.4	79.6	71.0	60.4	48.0	34.7	22.0	11.9	4.7	42.1
42	91.7	86.3	79.5	70.9	60.3	47.9	34.7	22.0	11.9	4.7	42
41.5	91.5	86.1	79.3	70.8	60.3	47.9	34.7	22.0	11.9	4.7	41.5
41.4	91.3	85.9	79.2	70.7	60.2	47.9	34.7	22.0	11.9	4.7	41.4
41.3	91.1	85.8	79.1	70.6	60.1	47.8	34.7	22.0	11.9	4.7	41.3
41.2	90.9	85.6	78.9	70.5	60.1	47.8	34.7	22.0	11.9	4.7	41.2
41.1	90.7	85.4	78.8	70.4	60.0	47.8	34.6	22.0	11.9	4.7	41.1
41	90.5	85.3	78.7	70.3	59.9	47.8	34.6	22.0	11.9	4.7	41
40.5	90.3	85.1	78.5	70.2	59.9	47.7	34.6	22.0	11.9	4.7	40.5
40.4	90.1	84.9	78.4	70.1	59.8	47.7	34.6	22.0	11.9	4.7	40.4
40.3	89.9	84.7	78.2	69.9	59.7	47.7	34.6	22.0	11.9	4.7	40.3
40.2	89.7	84.6	78.1	69.8	59.7	47.6	34.6	22.0	11.9	4.7	40.2
40.1	89.5	84.4	77.9	69.7	59.6	47.6	34.6	22.0	11.9	4.7	40.1
40	89.3	84.2	77.8	69.6	59.5	47.6	34.6	22.0	11.9	4.7	40

The D/L (Duckworth-Lewis) method of adjusting target scores in
interrupted one-day cricket matches - Standard Edition***Use only when Professional Edition is not available.**

Table of resource percentages remaining - ball by ball

Overs left 40 to 30

OVERS LEFT	WICKETS LOST									OVERS LEFT	
	0	1	2	3	4	5	6	7	8		9
40	89.3	84.2	77.8	69.6	59.5	47.6	34.6	22.0	11.9	4.7	40
39.5	89.1	84.0	77.7	69.5	59.5	47.5	34.6	22.0	11.9	4.7	39.5
39.4	88.9	83.9	77.5	69.4	59.4	47.5	34.6	22.0	11.9	4.7	39.4
39.3	88.6	83.7	77.4	69.3	59.3	47.5	34.6	22.0	11.9	4.7	39.3
39.2	88.4	83.5	77.2	69.2	59.3	47.4	34.5	22.0	11.9	4.7	39.2
39.1	88.2	83.3	77.1	69.1	59.2	47.4	34.5	22.0	11.9	4.7	39.1
39	88.0	83.1	76.9	69.0	59.1	47.4	34.5	22.0	11.9	4.7	39
38.5	87.8	83.0	76.8	68.9	59.0	47.3	34.5	21.9	11.9	4.7	38.5
38.4	87.6	82.8	76.6	68.7	59.0	47.3	34.5	21.9	11.9	4.7	38.4
38.3	87.4	82.6	76.5	68.6	58.9	47.3	34.5	21.9	11.9	4.7	38.3
38.2	87.2	82.4	76.3	68.5	58.8	47.2	34.5	21.9	11.9	4.7	38.2
38.1	87.0	82.2	76.2	68.4	58.8	47.2	34.5	21.9	11.9	4.7	38.1
38	86.7	82.0	76.0	68.3	58.7	47.1	34.5	21.9	11.9	4.7	38
37.5	86.5	81.8	75.8	68.2	58.6	47.1	34.4	21.9	11.9	4.7	37.5
37.4	86.3	81.6	75.7	68.0	58.5	47.1	34.4	21.9	11.9	4.7	37.4
37.3	86.1	81.5	75.5	67.9	58.4	47.0	34.4	21.9	11.9	4.7	37.3
37.2	85.9	81.3	75.4	67.8	58.4	47.0	34.4	21.9	11.9	4.7	37.2
37.1	85.6	81.1	75.2	67.7	58.3	46.9	34.4	21.9	11.9	4.7	37.1
37	85.4	80.9	75.0	67.6	58.2	46.9	34.4	21.9	11.9	4.7	37
36.5	85.2	80.7	74.9	67.4	58.1	46.9	34.4	21.9	11.9	4.7	36.5
36.4	85.0	80.5	74.7	67.3	58.0	46.8	34.4	21.9	11.9	4.7	36.4
36.3	84.8	80.3	74.6	67.2	58.0	46.8	34.3	21.9	11.9	4.7	36.3
36.2	84.5	80.1	74.4	67.1	57.9	46.7	34.3	21.9	11.9	4.7	36.2
36.1	84.3	79.9	74.2	66.9	57.8	46.7	34.3	21.9	11.9	4.7	36.1
36	84.1	79.7	74.1	66.8	57.7	46.6	34.3	21.9	11.9	4.7	36
35.5	83.8	79.5	73.9	66.7	57.6	46.6	34.3	21.9	11.9	4.7	35.5
35.4	83.6	79.3	73.7	66.6	57.5	46.6	34.3	21.9	11.9	4.7	35.4
35.3	83.4	79.1	73.6	66.4	57.4	46.5	34.3	21.9	11.9	4.7	35.3
35.2	83.2	78.9	73.4	66.3	57.4	46.5	34.2	21.9	11.9	4.7	35.2
35.1	82.9	78.7	73.2	66.2	57.3	46.4	34.2	21.9	11.9	4.7	35.1
35	82.7	78.5	73.0	66.0	57.2	46.4	34.2	21.9	11.9	4.7	35
34.5	82.5	78.3	72.9	65.9	57.1	46.3	34.2	21.9	11.9	4.7	34.5
34.4	82.2	78.0	72.7	65.8	57.0	46.3	34.2	21.9	11.9	4.7	34.4
34.3	82.0	77.8	72.5	65.6	56.9	46.2	34.2	21.9	11.9	4.7	34.3
34.2	81.7	77.6	72.3	65.5	56.8	46.2	34.2	21.9	11.9	4.7	34.2
34.1	81.5	77.4	72.2	65.3	56.7	46.1	34.1	21.9	11.9	4.7	34.1
34	81.3	77.2	72.0	65.2	56.6	46.1	34.1	21.9	11.9	4.7	34
33.5	81.0	77.0	71.8	65.1	56.5	46.0	34.1	21.9	11.9	4.7	33.5
33.4	80.8	76.8	71.6	64.9	56.4	46.0	34.1	21.9	11.9	4.7	33.4
33.3	80.5	76.6	71.4	64.8	56.3	45.9	34.1	21.9	11.9	4.7	33.3
33.2	80.3	76.3	71.3	64.6	56.2	45.9	34.0	21.9	11.9	4.7	33.2
33.1	80.0	76.1	71.1	64.5	56.1	45.8	34.0	21.9	11.9	4.7	33.1
33	79.8	75.9	70.9	64.4	56.0	45.8	34.0	21.9	11.9	4.7	33
32.5	79.5	75.7	70.7	64.2	55.9	45.7	34.0	21.9	11.9	4.7	32.5
32.4	79.3	75.5	70.5	64.1	55.8	45.7	34.0	21.9	11.9	4.7	32.4
32.3	79.0	75.2	70.3	63.9	55.7	45.6	33.9	21.9	11.9	4.7	32.3
32.2	78.8	75.0	70.1	63.8	55.6	45.5	33.9	21.9	11.9	4.7	32.2
32.1	78.5	74.8	69.9	63.6	55.5	45.5	33.9	21.9	11.9	4.7	32.1
32	78.3	74.6	69.7	63.5	55.4	45.4	33.9	21.9	11.9	4.7	32
31.5	78.0	74.3	69.6	63.3	55.3	45.4	33.9	21.9	11.9	4.7	31.5
31.4	77.8	74.1	69.4	63.2	55.2	45.3	33.8	21.9	11.9	4.7	31.4
31.3	77.5	73.9	69.2	63.0	55.1	45.2	33.8	21.9	11.9	4.7	31.3
31.2	77.3	73.6	69.0	62.8	55.0	45.2	33.8	21.9	11.9	4.7	31.2
31.1	77.0	73.4	68.8	62.7	54.9	45.1	33.8	21.9	11.9	4.7	31.1
31	76.7	73.2	68.6	62.5	54.8	45.1	33.7	21.9	11.9	4.7	31
30.5	76.5	72.9	68.4	62.4	54.7	45.0	33.7	21.9	11.9	4.7	30.5
30.4	76.2	72.7	68.2	62.2	54.5	44.9	33.7	21.9	11.9	4.7	30.4
30.3	75.9	72.5	68.0	62.0	54.4	44.9	33.7	21.8	11.9	4.7	30.3
30.2	75.7	72.2	67.8	61.9	54.3	44.8	33.6	21.8	11.9	4.7	30.2
30.1	75.4	72.0	67.6	61.7	54.2	44.7	33.6	21.8	11.9	4.7	30.1
30	75.1	71.8	67.3	61.6	54.1	44.7	33.6	21.8	11.9	4.7	30

The D/L (Duckworth-Lewis) method of adjusting target scores in interrupted one-day cricket matches - Standard Edition

*Use only when Professional Edition is not available.

Table of resource percentages remaining - ball by ball

Overs left 30 to 20

OVERS LEFT	WICKETS LOST									OVERS LEFT	
	0	1	2	3	4	5	6	7	8		9
30	75.1	71.8	67.3	61.6	54.1	44.7	33.6	21.8	11.9	4.7	30
29.5	74.9	71.5	67.1	61.4	54.0	44.6	33.6	21.8	11.9	4.7	29.5
29.4	74.6	71.3	66.9	61.2	53.8	44.5	33.5	21.8	11.9	4.7	29.4
29.3	74.3	71.0	66.7	61.1	53.7	44.4	33.5	21.8	11.9	4.7	29.3
29.2	74.1	70.8	66.5	60.9	53.6	44.4	33.5	21.8	11.9	4.7	29.2
29.1	73.8	70.5	66.3	60.7	53.5	44.3	33.5	21.8	11.9	4.7	29.1
29	73.5	70.3	66.1	60.5	53.4	44.2	33.4	21.8	11.9	4.7	29
28.5	73.2	70.0	65.9	60.4	53.2	44.2	33.4	21.8	11.9	4.7	28.5
28.4	73.0	69.8	65.6	60.2	53.1	44.1	33.4	21.8	11.9	4.7	28.4
28.3	72.7	69.5	65.4	60.0	53.0	44.0	33.3	21.8	11.9	4.7	28.3
28.2	72.4	69.3	65.2	59.8	52.8	43.9	33.3	21.8	11.9	4.7	28.2
28.1	72.1	69.0	65.0	59.7	52.7	43.9	33.3	21.8	11.9	4.7	28.1
28	71.8	68.8	64.8	59.5	52.6	43.8	33.2	21.8	11.9	4.7	28
27.5	71.5	68.5	64.5	59.3	52.4	43.7	33.2	21.8	11.9	4.7	27.5
27.4	71.3	68.2	64.3	59.1	52.3	43.6	33.2	21.8	11.9	4.7	27.4
27.3	71.0	68.0	64.1	58.9	52.2	43.5	33.1	21.8	11.9	4.7	27.3
27.2	70.7	67.7	63.9	58.7	52.0	43.4	33.1	21.8	11.9	4.7	27.2
27.1	70.4	67.5	63.6	58.5	51.9	43.4	33.1	21.7	11.9	4.7	27.1
27	70.1	67.2	63.4	58.4	51.8	43.3	33.0	21.7	11.9	4.7	27
26.5	69.8	66.9	63.2	58.2	51.6	43.2	33.0	21.7	11.9	4.7	26.5
26.4	69.5	66.7	62.9	58.0	51.5	43.1	33.0	21.7	11.9	4.7	26.4
26.3	69.2	66.4	62.7	57.8	51.3	43.0	32.9	21.7	11.9	4.7	26.3
26.2	68.9	66.1	62.5	57.6	51.2	42.9	32.9	21.7	11.9	4.7	26.2
26.1	68.6	65.9	62.2	57.4	51.1	42.8	32.8	21.7	11.9	4.7	26.1
26	68.3	65.6	62.0	57.2	50.9	42.8	32.8	21.7	11.9	4.7	26
25.5	68.0	65.3	61.7	57.0	50.8	42.7	32.8	21.7	11.9	4.7	25.5
25.4	67.7	65.0	61.5	56.8	50.6	42.6	32.7	21.7	11.9	4.7	25.4
25.3	67.4	64.8	61.3	56.6	50.5	42.5	32.7	21.7	11.9	4.7	25.3
25.2	67.1	64.5	61.0	56.4	50.3	42.4	32.6	21.7	11.9	4.7	25.2
25.1	66.8	64.2	60.8	56.2	50.2	42.3	32.6	21.7	11.9	4.7	25.1
25	66.5	63.9	60.5	56.0	50.0	42.2	32.6	21.6	11.9	4.7	25
24.5	66.2	63.6	60.3	55.8	49.8	42.1	32.5	21.6	11.9	4.7	24.5
24.4	65.9	63.3	60.0	55.6	49.7	42.0	32.5	21.6	11.9	4.7	24.4
24.3	65.6	63.1	59.8	55.4	49.5	41.9	32.4	21.6	11.9	4.7	24.3
24.2	65.2	62.8	59.5	55.2	49.4	41.8	32.4	21.6	11.9	4.7	24.2
24.1	64.9	62.5	59.3	54.9	49.2	41.7	32.3	21.6	11.9	4.7	24.1
24	64.6	62.2	59.0	54.7	49.0	41.6	32.3	21.6	11.9	4.7	24
23.5	64.3	61.9	58.7	54.5	48.9	41.5	32.2	21.6	11.9	4.7	23.5
23.4	64.0	61.6	58.5	54.3	48.7	41.4	32.2	21.6	11.9	4.7	23.4
23.3	63.7	61.3	58.2	54.1	48.5	41.2	32.1	21.6	11.9	4.7	23.3
23.2	63.3	61.0	58.0	53.8	48.4	41.1	32.1	21.5	11.9	4.7	23.2
23.1	63.0	60.7	57.7	53.6	48.2	41.0	32.0	21.5	11.9	4.7	23.1
23	62.7	60.4	57.4	53.4	48.0	40.9	32.0	21.5	11.9	4.7	23
22.5	62.4	60.1	57.2	53.2	47.9	40.8	31.9	21.5	11.9	4.7	22.5
22.4	62.0	59.8	56.9	52.9	47.7	40.7	31.8	21.5	11.9	4.7	22.4
22.3	61.7	59.5	56.6	52.7	47.5	40.6	31.8	21.5	11.9	4.7	22.3
22.2	61.4	59.2	56.3	52.5	47.3	40.4	31.7	21.5	11.9	4.7	22.2
22.1	61.0	58.9	56.1	52.3	47.1	40.3	31.7	21.4	11.9	4.7	22.1
22	60.7	58.6	55.8	52.0	47.0	40.2	31.6	21.4	11.9	4.7	22
21.5	60.4	58.3	55.5	51.8	46.8	40.1	31.5	21.4	11.9	4.7	21.5
21.4	60.0	58.0	55.2	51.5	46.6	40.0	31.5	21.4	11.9	4.7	21.4
21.3	59.7	57.7	55.0	51.3	46.4	39.8	31.4	21.4	11.9	4.7	21.3
21.2	59.3	57.3	54.7	51.1	46.2	39.7	31.4	21.4	11.9	4.7	21.2
21.1	59.0	57.0	54.4	50.8	46.0	39.6	31.3	21.3	11.9	4.7	21.1
21	58.7	56.7	54.1	50.6	45.8	39.4	31.2	21.3	11.9	4.7	21
20.5	58.3	56.4	53.8	50.3	45.6	39.3	31.1	21.3	11.9	4.7	20.5
20.4	58.0	56.1	53.5	50.1	45.4	39.2	31.1	21.3	11.9	4.7	20.4
20.3	57.6	55.7	53.2	49.8	45.2	39.0	31.0	21.3	11.9	4.7	20.3
20.2	57.3	55.4	52.9	49.6	45.0	38.9	30.9	21.2	11.9	4.7	20.2
20.1	56.9	55.1	52.6	49.3	44.8	38.8	30.9	21.2	11.9	4.7	20.1
20	56.6	54.8	52.4	49.1	44.6	38.6	30.8	21.2	11.9	4.7	20

The D/L (Duckworth-Lewis) method of adjusting target scores in interrupted one-day cricket matches - Standard Edition

***Use only when Professional Edition is not available.**

Table of resource percentages remaining - ball by ball

Overs left 20 to 10

OVERS LEFT	WICKETS LOST									OVERS LEFT	
	0	1	2	3	4	5	6	7	8		9
20	56.6	54.8	52.4	49.1	44.6	38.6	30.8	21.2	11.9	4.7	20
19.5	56.2	54.4	52.1	48.8	44.4	38.5	30.7	21.2	11.9	4.7	19.5
19.4	55.9	54.1	51.8	48.6	44.2	38.3	30.6	21.2	11.9	4.7	19.4
19.3	55.5	53.8	51.5	48.3	44.0	38.2	30.6	21.1	11.9	4.7	19.3
19.2	55.1	53.4	51.1	48.0	43.8	38.0	30.5	21.1	11.9	4.7	19.2
19.1	54.8	53.1	50.8	47.8	43.6	37.9	30.4	21.1	11.9	4.7	19.1
19	54.4	52.8	50.5	47.5	43.4	37.7	30.3	21.1	11.9	4.7	19
18.5	54.1	52.4	50.2	47.2	43.2	37.6	30.2	21.0	11.9	4.7	18.5
18.4	53.7	52.1	49.9	47.0	42.9	37.4	30.1	21.0	11.9	4.7	18.4
18.3	53.3	51.7	49.6	46.7	42.7	37.3	30.0	21.0	11.9	4.7	18.3
18.2	52.9	51.4	49.3	46.4	42.5	37.1	30.0	21.0	11.9	4.7	18.2
18.1	52.6	51.0	49.0	46.1	42.3	36.9	29.9	20.9	11.9	4.7	18.1
18	52.2	50.7	48.6	45.9	42.0	36.8	29.8	20.9	11.9	4.7	18
17.5	51.8	50.3	48.3	45.6	41.8	36.6	29.7	20.9	11.9	4.7	17.5
17.4	51.5	50.0	48.0	45.3	41.6	36.4	29.6	20.8	11.9	4.7	17.4
17.3	51.1	49.6	47.7	45.0	41.3	36.3	29.5	20.8	11.9	4.7	17.3
17.2	50.7	49.3	47.4	44.7	41.1	36.1	29.4	20.8	11.9	4.7	17.2
17.1	50.3	48.9	47.0	44.4	40.9	35.9	29.3	20.7	11.9	4.7	17.1
17	49.9	48.5	46.7	44.1	40.6	35.8	29.2	20.7	11.9	4.7	17
16.5	49.5	48.2	46.4	43.8	40.4	35.6	29.1	20.7	11.9	4.7	16.5
16.4	49.2	47.8	46.0	43.6	40.1	35.4	29.0	20.6	11.9	4.7	16.4
16.3	48.8	47.5	45.7	43.3	39.9	35.2	28.9	20.6	11.9	4.7	16.3
16.2	48.4	47.1	45.4	43.0	39.6	35.0	28.8	20.5	11.9	4.7	16.2
16.1	48.0	46.7	45.0	42.7	39.4	34.8	28.6	20.5	11.8	4.7	16.1
16	47.6	46.3	44.7	42.3	39.1	34.7	28.5	20.5	11.8	4.7	16
15.5	47.2	46.0	44.3	42.0	38.9	34.5	28.4	20.4	11.8	4.7	15.5
15.4	46.8	45.6	44.0	41.7	38.6	34.3	28.3	20.4	11.8	4.7	15.4
15.3	46.4	45.2	43.6	41.4	38.4	34.1	28.2	20.3	11.8	4.7	15.3
15.2	46.0	44.8	43.3	41.1	38.1	33.9	28.1	20.3	11.8	4.7	15.2
15.1	45.6	44.5	42.9	40.8	37.8	33.7	27.9	20.2	11.8	4.7	15.1
15	45.2	44.1	42.6	40.5	37.6	33.5	27.8	20.2	11.8	4.7	15
14.5	44.8	43.7	42.2	40.2	37.3	33.3	27.7	20.1	11.8	4.7	14.5
14.4	44.4	43.3	41.8	39.8	37.0	33.1	27.5	20.1	11.8	4.7	14.4
14.3	44.0	42.9	41.5	39.5	36.8	32.8	27.4	20.0	11.8	4.7	14.3
14.2	43.5	42.5	41.1	39.2	36.5	32.6	27.3	20.0	11.8	4.7	14.2
14.1	43.1	42.1	40.8	38.9	36.2	32.4	27.1	19.9	11.8	4.7	14.1
14	42.7	41.7	40.4	38.5	35.9	32.2	27.0	19.9	11.8	4.7	14
13.5	42.3	41.3	40.0	38.2	35.6	32.0	26.9	19.8	11.8	4.7	13.5
13.4	41.9	40.9	39.6	37.9	35.3	31.8	26.7	19.7	11.8	4.7	13.4
13.3	41.5	40.5	39.3	37.5	35.0	31.5	26.6	19.7	11.7	4.7	13.3
13.2	41.0	40.1	38.9	37.2	34.8	31.3	26.4	19.6	11.7	4.7	13.2
13.1	40.6	39.7	38.5	36.8	34.5	31.1	26.3	19.5	11.7	4.7	13.1
13	40.2	39.3	38.1	36.5	34.2	30.8	26.1	19.5	11.7	4.7	13
12.5	39.8	38.9	37.7	36.1	33.9	30.6	25.9	19.4	11.7	4.7	12.5
12.4	39.3	38.5	37.4	35.8	33.6	30.4	25.8	19.3	11.7	4.7	12.4
12.3	38.9	38.1	37.0	35.4	33.2	30.1	25.6	19.3	11.7	4.7	12.3
12.2	38.5	37.7	36.6	35.1	32.9	29.9	25.5	19.2	11.7	4.7	12.2
12.1	38.0	37.2	36.2	34.7	32.6	29.6	25.3	19.1	11.6	4.7	12.1
12	37.6	36.8	35.8	34.3	32.3	29.4	25.1	19.0	11.6	4.7	12
11.5	37.1	36.4	35.4	34.0	32.0	29.1	24.9	18.9	11.6	4.7	11.5
11.4	36.7	36.0	35.0	33.6	31.7	28.8	24.8	18.9	11.6	4.7	11.4
11.3	36.2	35.5	34.6	33.2	31.3	28.6	24.6	18.8	11.6	4.7	11.3
11.2	35.8	35.1	34.2	32.9	31.0	28.3	24.4	18.7	11.6	4.7	11.2
11.1	35.3	34.7	33.8	32.5	30.7	28.0	24.2	18.6	11.5	4.7	11.1
11	34.9	34.2	33.4	32.1	30.4	27.8	24.0	18.5	11.5	4.7	11
10.5	34.4	33.8	32.9	31.7	30.0	27.5	23.8	18.4	11.5	4.7	10.5
10.4	34.0	33.4	32.5	31.4	29.7	27.2	23.6	18.3	11.5	4.7	10.4
10.3	33.5	32.9	32.1	31.0	29.3	26.9	23.4	18.2	11.5	4.7	10.3
10.2	33.1	32.5	31.7	30.6	29.0	26.6	23.2	18.1	11.4	4.7	10.2
10.1	32.6	32.0	31.3	30.2	28.6	26.4	23.0	18.0	11.4	4.7	10.1
10	32.1	31.6	30.8	29.8	28.3	26.1	22.8	17.9	11.4	4.7	10

The D/L (Duckworth-Lewis) method of adjusting target scores in interrupted one-day cricket matches - Standard Edition

*Use only when Professional Edition is not available.

Table of resource percentages remaining - ball by ball

Overs left 10 to 0

OVERS LEFT	WICKETS LOST									OVERS LEFT	
	0	1	2	3	4	5	6	7	8		9
10	32.1	31.6	30.8	29.8	28.3	26.1	22.8	17.9	11.4	4.7	10
9.5	31.7	31.1	30.4	29.4	27.9	25.8	22.6	17.7	11.4	4.7	9.5
9.4	31.2	30.7	30.0	29.0	27.6	25.5	22.3	17.6	11.3	4.7	9.4
9.3	30.7	30.2	29.6	28.6	27.2	25.2	22.1	17.5	11.3	4.7	9.3
9.2	30.3	29.8	29.1	28.2	26.8	24.9	21.9	17.4	11.3	4.7	9.2
9.1	29.8	29.3	28.7	27.8	26.5	24.5	21.7	17.2	11.2	4.7	9.1
9	29.3	28.9	28.2	27.4	26.1	24.2	21.4	17.1	11.2	4.7	9
8.5	28.8	28.4	27.8	26.9	25.7	23.9	21.2	17.0	11.1	4.7	8.5
8.4	28.3	27.9	27.3	26.5	25.3	23.6	20.9	16.8	11.1	4.7	8.4
8.3	27.9	27.5	26.9	26.1	25.0	23.3	20.7	16.7	11.1	4.7	8.3
8.2	27.4	27.0	26.4	25.7	24.6	22.9	20.4	16.5	11.0	4.7	8.2
8.1	26.9	26.5	26.0	25.3	24.2	22.6	20.2	16.4	11.0	4.7	8.1
8	26.4	26.0	25.5	24.8	23.8	22.3	19.9	16.2	10.9	4.7	8
7.5	25.9	25.6	25.1	24.4	23.4	21.9	19.6	16.0	10.9	4.7	7.5
7.4	25.4	25.1	24.6	24.0	23.0	21.6	19.4	15.9	10.8	4.7	7.4
7.3	24.9	24.6	24.1	23.5	22.6	21.2	19.1	15.7	10.7	4.7	7.3
7.2	24.4	24.1	23.7	23.1	22.2	20.9	18.8	15.5	10.7	4.7	7.2
7.1	23.9	23.6	23.2	22.6	21.8	20.5	18.5	15.3	10.6	4.7	7.1
7	23.4	23.1	22.7	22.2	21.4	20.1	18.2	15.2	10.5	4.7	7
6.5	22.9	22.6	22.3	21.7	20.9	19.8	17.9	15.0	10.5	4.7	6.5
6.4	22.4	22.1	21.8	21.3	20.5	19.4	17.6	14.8	10.4	4.7	6.4
6.3	21.9	21.6	21.3	20.8	20.1	19.0	17.3	14.6	10.3	4.7	6.3
6.2	21.4	21.1	20.8	20.3	19.7	18.6	17.0	14.4	10.2	4.7	6.2
6.1	20.8	20.6	20.3	19.9	19.2	18.2	16.7	14.1	10.1	4.7	6.1
6	20.3	20.1	19.8	19.4	18.8	17.8	16.4	13.9	10.1	4.6	6
5.5	19.8	19.6	19.3	18.9	18.3	17.4	16.0	13.7	10.0	4.6	5.5
5.4	19.3	19.1	18.8	18.5	17.9	17.0	15.7	13.5	9.8	4.6	5.4
5.3	18.8	18.6	18.3	18.0	17.4	16.6	15.4	13.2	9.7	4.6	5.3
5.2	18.2	18.1	17.8	17.5	17.0	16.2	15.0	13.0	9.6	4.6	5.2
5.1	17.7	17.5	17.3	17.0	16.5	15.8	14.7	12.7	9.5	4.6	5.1
5	17.2	17.0	16.8	16.5	16.1	15.4	14.3	12.5	9.4	4.6	5
4.5	16.6	16.5	16.3	16.0	15.6	15.0	13.9	12.2	9.2	4.6	4.5
4.4	16.1	16.0	15.8	15.5	15.1	14.5	13.6	11.9	9.1	4.6	4.4
4.3	15.6	15.4	15.3	15.0	14.7	14.1	13.2	11.6	8.9	4.6	4.3
4.2	15.0	14.9	14.7	14.5	14.2	13.6	12.8	11.3	8.8	4.5	4.2
4.1	14.5	14.4	14.2	14.0	13.7	13.2	12.4	11.0	8.6	4.5	4.1
4	13.9	13.8	13.7	13.5	13.2	12.7	12.0	10.7	8.4	4.5	4
3.5	13.4	13.3	13.2	13.0	12.7	12.3	11.6	10.4	8.3	4.5	3.5
3.4	12.8	12.7	12.6	12.5	12.2	11.8	11.2	10.1	8.1	4.4	3.4
3.3	12.3	12.2	12.1	11.9	11.7	11.3	10.8	9.7	7.9	4.4	3.3
3.2	11.7	11.6	11.5	11.4	11.2	10.9	10.3	9.4	7.7	4.3	3.2
3.1	11.1	11.1	11.0	10.9	10.7	10.4	9.9	9.0	7.4	4.3	3.1
3	10.6	10.5	10.4	10.3	10.2	9.9	9.5	8.7	7.2	4.2	3
2.5	10.0	10.0	9.9	9.8	9.6	9.4	9.0	8.3	6.9	4.2	2.5
2.4	9.4	9.4	9.3	9.3	9.1	8.9	8.5	7.9	6.7	4.1	2.4
2.3	8.9	8.8	8.8	8.7	8.6	8.4	8.1	7.5	6.4	4.0	2.3
2.2	8.3	8.3	8.2	8.2	8.0	7.9	7.6	7.1	6.1	3.9	2.2
2.1	7.7	7.7	7.7	7.6	7.5	7.4	7.1	6.7	5.8	3.8	2.1
2	7.2	7.1	7.1	7.0	7.0	6.8	6.6	6.2	5.5	3.7	2
1.5	6.6	6.5	6.5	6.5	6.4	6.3	6.1	5.8	5.1	3.6	1.5
1.4	6.0	6.0	5.9	5.9	5.9	5.8	5.6	5.3	4.8	3.4	1.4
1.3	5.4	5.4	5.4	5.3	5.3	5.2	5.1	4.9	4.4	3.2	1.3
1.2	4.8	4.8	4.8	4.8	4.7	4.7	4.6	4.4	4.0	3.0	1.2
1.1	4.2	4.2	4.2	4.2	4.2	4.1	4.0	3.9	3.6	2.8	1.1
1	3.6	3.6	3.6	3.6	3.6	3.5	3.5	3.4	3.2	2.5	1
0.5	3.0	3.0	3.0	3.0	3.0	3.0	2.9	2.9	2.7	2.2	0.5
0.4	2.4	2.4	2.4	2.4	2.4	2.4	2.4	2.3	2.2	1.9	0.4
0.3	1.8	1.8	1.8	1.8	1.8	1.8	1.8	1.8	1.7	1.5	0.3
0.2	1.2	1.2	1.2	1.2	1.2	1.2	1.2	1.2	1.2	1.1	0.2
0.1	0.6	0.6	0.6	0.6	0.6	0.6	0.6	0.6	0.6	0.6	0.1
0	0.0	0.0	0.0	0.0	0.0	0.0	0.0	0.0	0.0	0.0	0

WOMEN'S **TEST MATCH** PLAYING CONDITIONS

WOMEN'S TEST MATCH PLAYING CONDITIONS

These playing conditions are applicable to all Test Matches from 1st October 2013 and supersede the previous version dated 30 April 2013. Included in this version are amendments to clauses 1.3, 2.2.2, 17.1, 17.2, 19.1, 19.3, 23.1, 42.1, 42.1.1, Appendix 2 and new clauses 24.2 and 42.1.2.

Except as varied hereunder, the Laws of Cricket (2000 Code - 5th Edition 2013) shall apply.

Note: All references to 'Governing Body' within the Laws of Cricket shall be replaced by 'ICC Match Referee'. The ICC Match Referee may or may not be present at the match.

1 LAW 1 THE PLAYERS

1.1 Law 1.1 - Number of Players

Law 1.1 shall be replaced by the following:

A match is played between two sides. Each side shall consist of 11 players, one of whom shall be captain.

1.2 Law 1.2 - Nomination of Players

Law 1.2 shall be replaced by the following:

- 1.2.1 Each captain shall nominate 11 players plus a maximum of 4 substitute fielders in writing to the ICC match referee before the toss. No player (member of the playing eleven) may be changed after the nomination without the consent of the opposing captain.
- 1.2.2 Only those nominated as substitute fielders shall be entitled to act as substitute fielders during the match, unless the match referee, in exceptional circumstances, allows subsequent additions.
- 1.2.3 All those nominated including those nominated as substitute fielders, must be eligible to play for that particular team and by such nomination the nominees shall warrant that they are so eligible.
- 1.2.4 In addition, by their nomination, the nominees shall be deemed to have agreed to abide by all the applicable ICC Regulations pertaining to international cricket and in particular, the Clothing and Equipment Regulations, the Code of Conduct for Players and Player Support Personnel (hereafter referred to as the ICC Code of Conduct), the Anti-Racism Code for Players and Player Support Personnel, the Anti-Doping Code and the Anti-Corruption Code.

1.3 Law 1.3 – Captain

The following shall apply in addition to Law 1.3 (a):

The deputy must be one of the nominated members of the playing eleven.

Each Member Board must nominate its 'Test Captain' to the ICC when appointed.

If the 'Test Team Captain' is not participating in a series, the relevant Home Board must nominate a replacement 'Test Team Captain' for the series. The Home Board shall advise the series Match Referee.

If the 'Test Team Captain' plays in a match without being the nominated captain for that match, she will be deemed to be the captain should any penalties be applied for the over rate breaches under the Code of Conduct.

2 LAW 2 - SUBSTITUTES AND RUNNERS

2.1 Law 2.1 Substitutes and Runners

Law 2.1 (a) (ii), 2.7 and 2.8 shall not apply. A runner for a batter when batting is not permitted.

Law 2.1 (b) shall be amended as follows:

The umpires shall have discretion to allow, for other wholly acceptable reasons, a substitute fielder to act for a nominated player, at the start of the match, or at any subsequent time.

2.2 Law 2.5 - Fielder absent or leaving the field

Law 2.5 shall be replaced by the following:

If a fielder fails to take the field with her side at the start of the match or at any later time, or leaves the field during a session of play, the umpire shall be informed of the reason for her absence, and she shall not thereafter come on to the field during a session of play without the consent of the umpire. (See Law 2.6 as modified). The umpire shall give such consent as soon as practicable.

If the player is absent from the field for longer than 8 minutes:

2.2.1 the player shall not be permitted to bowl in that innings after her return until she has been on the field for at least that length of playing time for which she was absent. Such absence or penalty time absent shall be carried over into a new day's play and in the event of a follow-on or forfeiture, this restriction will, if necessary, continue into the second innings.

2.2.2 the player shall not be permitted to bat unless or until, in the aggregate, she has returned to the field and/or her side's innings has been in progress for at least that length of playing time for which she has been absent or, if earlier, when her side has lost five wickets.

The restriction in Clauses 2.1.1 and 2.1.2 above shall not apply if the player has suffered an external blow (as opposed to an internal injury such as a pulled muscle) whilst participating earlier in the match and consequently been forced to leave the field. Nor shall it apply if the player has been absent for very exceptional and wholly acceptable reasons (other than injury or illness).

In the event of a batter or a fielder already being off the field at the commencement of an interruption in play through ground, weather or light conditions or for other exceptional circumstances, she shall be allowed to count any such stoppage time as playing time, provided that she personally informs the umpires when she is fit enough to take the field had play been in progress. Similarly, if at the commencement of an interruption in play through ground, weather or light conditions or for other exceptional circumstances, a player is on the field but still has some unexpired penalty time remaining from a previous absence, he shall automatically be allowed to count any such stoppage time as playing time.

2.2.3 Substitute fielders shall only be permitted in cases of injury, illness or other wholly acceptable reasons. 'Wholly acceptable reasons' should be limited to extreme circumstances and should not include what is commonly referred to as a 'comfort break'.

Note: Squad members of the fielding or batting team who are not playing in the match and who are not acting as substitute fielders shall be required to wear a team training bib whilst on the playing area (including the area between the boundary and the perimeter fencing).

3 LAW 3 - THE UMPIRES**3.1 Law 3.1 - Appointment and attendance**

Law 3.1 shall be replaced by the following:

The following rules for the selection and appointment of Test Match umpires shall be followed as far as it is practicable to do so:

- 3.1.1 Depending on the nature of the tournament, the Home Board shall appoint ICC approved umpires for on-field and third umpire duties. For televised matches the responsibility of the third umpire will be to act as an emergency umpire and officiate in regard to TV replays. For non-televised matches, the responsibility of the third umpire will be to act as an emergency umpire and carry out the tasks prescribed for the third and fourth umpires (note: a fourth umpire is not required for international women's matches).
- 3.1.2 Neither team will have a right of objection to an umpire's appointment.
- 3.1.3 The umpires shall be present at the ground at least 90 minutes before the scheduled start of play.

3.2 Third Umpire/TV Replays

The playing conditions set out in Appendix 2 shall apply

3.3 Law 3.2 - Change of umpire

Law 3.2 shall be replaced by the following:

An umpire shall not be changed during the match, other than in exceptional circumstances, unless they are injured or ill.

3.4 Law 3.4 - To inform captains and scorers

The following shall apply in addition to Law 3.4 (i):

The host country may provide for the ringing of a bell, which shall be rung 5 minutes before the termination of an interval, when the umpires shall go to the wickets. The host country shall inform the visiting country at the start of the tour that this practice is to be adopted.

3.5 Law 3.8 - Fitness for play and Law 3.9 - Suspension of play in dangerous or unreasonable conditions.

- 3.5.1 The safety of all persons within the ground is of paramount importance to the ICC. In the event that any threatening circumstance, whether actual or perceived, comes to the attention of any umpire (including for example weather, pitch invasions, act of God, etc. See also 3.6), then the players and officials should immediately be asked to leave the field of play in a safe and orderly manner and to relocate to a secure and safe area (depending on each particular threat) pending the satisfactory passing or resolution of such threat or risk to the reasonable satisfaction of the umpires, ICC Match Referee, the head of the relevant ground authority, the head of ground security and/or the police as the circumstances may require.

Laws 3.8 & 3.9 shall be replaced by:

- 3.5.2 The umpires shall be the final judges of the fitness of the ground, weather and light for play. See 3.5.3 below and Law 7.2 (Fitness of the pitch for play).

3.5.3 Suspension of play for adverse conditions of ground, weather or light.

- a) All references to ground include the pitch. See Law 7.1 (Area of pitch).
- b) If at any time the umpires together agree that the conditions of ground, weather or light are so bad that there is obvious and foreseeable risk to the safety of any player or umpire, so that it would be unreasonable or dangerous for play to take place, then they shall immediately suspend play, or not allow play to commence or to restart. The decision as to whether conditions are so bad as to warrant such action is one for the umpires alone to make.

The fact that the grass and the ball are wet and slippery does not warrant the ground conditions being regarded as unreasonable or dangerous. If the umpires consider the ground is so wet or slippery as to deprive the bowler of a reasonable foothold, the fielders of the power of free movement, or the batsmen of the ability to play their strokes or to run between the wickets, then these conditions shall be regarded as so bad that it would be unreasonable for play to take place.

The Umpires shall disregard any shadow on the pitch from the stadium or from any permanent object on the ground.

- c) When there is a suspension of play it is the responsibility of the umpires to monitor the conditions. They shall make inspections as often as appropriate. Immediately the umpires together agree that conditions are suitable for play they shall call upon the players to resume the game.
 - d) If play is in progress up to the start of an agreed interval then it will resume after the interval unless the umpires together agree that the conditions of ground, weather or light are so bad that there is obvious and foreseeable risk to the safety of any player or umpire, so that it would be unreasonable or dangerous for play to take place.
- 3.5.4 Play may be suspended due to safety and security concerns by the umpires on the advice of the ICC Match Referee (if one is present and on duty at the match), the head of the relevant ground authority, the head of ground security or the police.
- 3.5.5 Where play is suspended under Clause 3.5.4 above the decision to abandon or resume play shall be the responsibility of the ICC Match Referee (or umpires if no match referee is present and on duty at the match) who shall act only after consultation with the head of ground security and the police.

3.6 Light Meters

- 3.6.1 It is the responsibility of each Home Board to supply light meters to all umpires standing in international matches in accordance herewith.
- a) All light meters shall be uniformly calibrated.
 - b) The umpires shall be entitled to use light meter readings as a guideline for determining whether the light is fit for play in accordance with the criteria set out in clause 3.5.3 (b) above.
 - c) Light meter readings may accordingly be used by the umpires:

- d) To determine whether there has been at any stage a deterioration or improvement in the light.
- e) As benchmarks for the remainder of a stoppage, match and/or series/event.

3.7 Use of artificial lights

If in the opinion of the umpires, natural light is deteriorating to an unfit level, they shall authorize the ground authorities to use the available artificial lighting so that the match can continue in acceptable conditions.

The lights are only to be used to enable a full days play to be completed as provided in Clause 16 Hours of Play, Intervals and Minimum Overs in the Day.

In the event of power failure or lights malfunction, the existing provisions of Clauses 15 and 16 shall apply.

The use of artificial lighting is to be determined by the Home Board and the Home Board is to advise the visiting Board as to whether this may occur during a tour.

The suitability of lights at all venues will be established prior to the commencement of the series.

3.8 Advertising on grounds, perimeter boards and sightscreens

3.8.1 Advertising on grounds

The logos on outfields are to be positioned as follows:

- a) Behind the stumps – a minimum of 25.15 yards (23 meters) from the stumps.
- b) Midwicket/cover area – no advertising to be positioned within 25.15 yards (23 meters) of the centre of the pitch being used for the match.

Note: Advertising closer to the stumps as set out above which is required to meet 3D requirements for broadcasters may be permitted, subject to prior ICC approval having been obtained.

3.8.2 Perimeter Boards

- a) Advertising on perimeter boards placed in front of the sightscreens is permitted save that the predominant colour of such advertising shall be of a contrasting colour to that of the ball.
- b) Advertising on perimeter boards behind the stumps at both ends shall not contain moving, flashing or flickering images and operators should ensure that the images are only changed or moved at a time that will not be distracting to the players or the umpires.
- c) In addition, the brightness of any electronic images shall be set at a level so that it is not a distraction to the players or umpires.

3.8.3 Sightscreens

- a) Sightscreens shall be provided at both ends of all grounds.
- b) Advertising shall be permitted on the sightscreen behind the striker, providing it is removed for the subsequent over from that end.
- c) Such advertising shall not contain flashing or flickering images and particular care should be taken by the operators that the advertising is not changed at a time which is distracting to the umpire.

4 LAW 4 - THE SCORERS

Law 4 shall apply.

5 LAW 5 - THE BALL

5.1 Law 5.2 - Approval and control of balls

Law 5.2 shall be replaced by the following:

The Home Board shall provide the best available high quality cricket balls (e.g. Kookaburra 'Turf' or its equivalent) and spare used balls for changing during a match, which shall also be of the same brand. Note: The Home Board shall be required to advise the visiting Board of the brand of ball to be used in the match(es) at least 30 days prior to the start of the match(es).

The fielding captain or her nominee may select the ball with which she wishes to bowl from the supply provided by the Home Board. The third umpire shall take a box containing at least 6 new balls to the dressing room and supervise the selection of the ball.

The umpires shall retain possession of the match ball(s) throughout the duration of the match when play is not actually taking place. During play umpires shall periodically and irregularly inspect the condition of the ball and shall retain possession of it at the fall of a wicket, a drinks interval, or any other disruption in play.

5.2 Law 5.4 - New ball in a match of more than one day's duration

Law 5.4 shall be replaced by the following:

The captain of the fielding side shall have the choice of taking a new ball at any time after 80 overs have been bowled with the previous ball. The umpires shall indicate to the batter and the scorers whenever a new ball is taken into play.

5.3 Law 5.5 - Ball lost or becoming unfit for play

The following shall apply in addition to Law 5.5: However, if the ball needs to be replaced after 110 overs for any of the reasons above, it shall be replaced by a new ball. If the ball is to be replaced, the umpire shall inform the batter.

5.4 Law 5.6 - Specifications

Law 5.6 (i) shall apply.

6 LAW 6 - THE BAT

6.1 Law 6.1 - Width and length

The following shall apply in addition to Law 6 (as amended in 2008):

Only Type A bats shall be used in Test matches.

7 LAW 7 - THE PITCH

7.1 Law 7.3 - Selection and preparation

The following will apply in addition to Law 7.3:

7.1.1 The ground staff shall ensure that during the period prior to the start of play and during intervals, the pitch area shall be roped off so as to prevent unauthorised access. (The pitch area shall include an area at least 2 metres beyond the rectangle made by the crease markings at both ends of the pitch).

- 7.1.2 The third umpire shall ensure that, prior to the start of play and during any intervals, only authorised staff, the ICC match officials, players, team coaches and authorised television personnel shall be allowed access to the pitch area. Such access shall be subject to the following limitations:
- Only captains and team coaches may walk on the actual playing surface of the pitch area (outside of the crease markings).
 - Access to the pitch area by television personnel shall be restricted to one camera crew (including one or two television commentators) of the official licensed television broadcasters(s) (but not news crews).
 - No spiked footwear shall be permitted.
 - No one shall be permitted to bounce a ball on the pitch, strike it with a bat or cause damage to the pitch in any other way.
 - Access shall not interfere with pitch preparation.
- 7.1.3 In the event of any dispute, the ICC Match Referee will rule and their ruling will be final.

7.2 Law 7.4 - Changing the pitch

The following shall apply, except that the reference to ICC Match Referee will only apply if one is present and on duty at the ground.

Law 7.4 shall be replaced by the following:

- 7.2.1 In the event of a pitch being considered too dangerous for play to continue in the estimation of the on-field umpires, they shall stop play and immediately advise the ICC Match Referee.
- 7.2.2 The on-field umpires and ICC Match Referee shall consult with both captains.
- 7.2.3 If the captains agree to continue, play shall resume.
- 7.2.4 If the decision is not to resume play, the on-field umpires together with the ICC Match Referee or umpires shall consider whether the existing pitch can be repaired and the match resumed from the point it was stopped. In considering whether to authorise such repairs, the ICC Match Referee or umpires must consider whether this would place either side at an unfair advantage, given the play that had already taken place on the dangerous pitch.
- 7.2.5 If the decision is that the existing pitch cannot be repaired, then the match is to be abandoned as a draw.
- 7.2.6 If the abandonment occurs on the first scheduled day of the match, the ICC Match Referee or umpires shall consult with the Home Board with the objective of finding a way for a new match to commence on the same date and venue. Such a match may be played either on the repaired pitch or on another pitch, subject to the ICC Match Referee or umpires and the relevant ground authority both being satisfied that the new pitch will be of the required Test standard. The playing time lost between the scheduled start time of the original match and the actual start time of the new match will be covered by the provisions of clause 16.
- 7.2.7 If it is not possible to start a new match on the scheduled first day of the original match, the relevant officials from the participating Boards shall agree on whether the match can be replayed within the existing tour schedule.

7.2.8 Throughout the above decision making processes, the ICC Match Referee or umpires shall keep informed both captains and the head of the ground authority. The head of the ground authority shall ensure that suitable and prompt public announcements are made.

7.3 Law 7.5 - Non-turf pitches

Law 7.5 shall not apply.

All matches shall be played on natural turf pitches. The use of PVA and other adhesives in the preparation of pitches is not permitted.

8 LAW 8 - THE WICKETS

8.1 Law 8.2 - Size of stumps

The following shall apply in addition to Law 8.2:

For televised matches the Home Board may provide a slightly larger cylindrical stump to accommodate the stump camera. When the larger stump is used, all three stumps must be exactly the same size.

9 LAW 9 - THE BOWLING, POPPING AND RETURN CREASES

9.1 Law 9.3 - The popping crease

Law 9.3 shall apply, except that the reference to 'a minimum of 6 ft' shall be replaced by 'a minimum of 15 yards (13.71 metres)'.

10 LAW 10 - PREPARATION AND MAINTENANCE OF THE PLAYING AREA

10.1 Law 10.1 - Rolling

The following shall apply in addition to Law 10.1:

10.1.1 Prior to tossing for choice of innings the artificial drying of the pitch and outfield shall be at the discretion of the ground manager. Thereafter and throughout the match the drying of the outfield may be undertaken at any time by the ground manager, but the drying of the affected area of the pitch shall be carried out only on the instructions and under the supervision of the umpires. The umpires shall be empowered to have the pitch dried without reference to the captains at any time they are of the opinion that it is unfit for play.

10.1.2 The umpires may instruct the ground manager to use any available equipment, including any roller for the purpose of drying the pitch and making it fit for play.

10.1.3 An absorbent roller may be used to remove water from the covers including the cover on the match pitch.

10.2 Law 10.6 - Maintenance of footholes

The following shall apply in addition to Law 10.6:

The umpires shall see that wherever possible and whenever it is considered necessary, action is taken during all intervals in play to do whatever is practicable to improve the bowler's foot holes. As soon as possible after the conclusion of each day's play, bowler's foot holes will be repaired.

10.3 Watering the outfield

The watering of the outfield will be permitted during the match subject to the following:

- 10.3.1 Such watering shall only be possible if the "watering plan" is requested by the ground curator and approved by the umpires before the match has started. Once the match has started, any such request will not be considered.
- 10.3.2 The consent of the captains is not required but the umpires shall advise both captains and the ICC Match Referee (if one is present and on duty at the ground) before the start of the match on what has been agreed.
- 10.3.3 The watering shall occur as soon as possible after the conclusion of the day's play.
- 10.3.4 The watering shall only be carried out to the extent that it is necessary to retain the good condition of the outfield.
- 10.3.5 The square and bowlers' run ups will be adequately covered prior to any watering taking place.
- 10.3.6 All ongoing matters of interpretation and implementation of watering requirements and regulations shall be resolved between the umpires and ground curator, but with the umpires retaining ultimate discretion over whether to approve any watering.

10.4 Protection and preparation of adjacent pitches during matches

The protection (by way of an appropriate cover) and preparation of pitches which are adjacent to the match pitch will be permitted during the match subject to the following:

- 10.4.1 Such measures will only be possible if requested by the ground curator and approved by the umpires before the start of the match.
- 10.4.2 Approval should only be granted where such measures are unavoidable and will not compromise the safety of the players or their ability to execute their actions with complete freedom.
- 10.4.3 The preparation work shall be carried out under the supervision of the fourth umpire.
- 10.4.4 Any necessary watering shall be carried out only to the extent necessary for such preparations and shall not be permitted in circumstances which may in any way affect the match pitch.
- 10.4.5 The consent of the captains is not required but the umpires shall advise both captains and the ICC Match Referee (if one is present and on duty at the ground) before the start of the match on what has been agreed.

11 LAW 11 - COVERING THE PITCH

11.1 Law 11.1 - Before the match

The following shall apply in addition to Law 11.1:

The pitch shall be entirely protected against rain up to the commencement of play.

11.2 Law 11.2 - During the match

Law 11.2 shall be replaced by the following:

The pitch shall be entirely protected against rain up to the commencement of play and for the duration of the period of the match. It shall be wholly covered at the termination of each day's play or providing the weather is fine, within a period of two hours thereafter.

Note: the covers must totally protect the pitch and also the pitch surroundings, a minimum 5 metres either side of the pitch and any worn or soft areas in the outfield.

11.3 Law 11.3 - Covering bowlers' run ups

Law 11.3 shall be replaced by the following:

The bowler's run-ups shall be covered, in inclement weather, in order to keep them dry, to a distance of at least 10 x 10 metres.

11.4 Law 11.4 - Removal of covers

Law 11.4 shall be replaced by the following:

All covers (including "hessian" or "scrim" covers used to protect the pitch against the sun) shall be removed not later than 2½ hours before the scheduled start of play provided it is not raining at the time, but the pitch will be covered again if rain falls prior to the commencement of play.

Attention is drawn to clauses 3.5 and 10.4 above.

12 LAW 12 - INNINGS

Law 12 shall apply subject to the following:

12.1 Law 12.1 (a) shall be replaced by the following: A match shall be two innings per side subject to the provisions of Law 13.1.

12.2 Law 12.1 (b) and 12.3 (e) shall not apply.

12.3 Matches shall be of four days scheduled duration, and of two innings per side. The two participating countries may:

- a) Provide for a rest day during the match, and/or a reserve day after the scheduled days of play.
- b) Play on any scheduled rest day, conditions and circumstances permitting, should a full day's play be lost on any day prior to the rest day.
- c) Play on any scheduled reserve day, conditions and circumstances permitting, should a full day's play be lost on any day. Play shall not take place on more than 4 days.
- d) Make up time lost in excess of five minutes in each day's play due to circumstances outside the game other than Acts of God.

12.4 Law 12.4 - The toss

Law 12.4 shall be replaced by the following:

The captains shall toss for the choice of innings, on the field of play and in the presence of the ICC Match Referee (if one is present and on duty at the ground), who shall supervise the toss. The toss shall take place not earlier than 30 minutes, nor later than 15 minutes before the scheduled or any rescheduled time for the match to start. Note, however, the provisions of Law 1.3 (Captain).

Note: Law 12.5 requiring the captain of the side winning the toss to notify the opposing captain as soon as the toss is completed of his decision to bat or to field shall apply.

13 LAW 13 - THE FOLLOW-ON**13.1 Law 13.3 - First day's play lost**

If the provision of Clause 16.1.3 (b) is applied, the additional time is regarded as part of that day's play, i.e. it is the number of days remaining, and not the total number of hours available.

14 LAW 14 - DECLARATION AND FORFEITURE

Law 14 shall apply.

15 LAW 15 - INTERVALS**15.1 Law 15.3 - Duration of intervals**

15.1.1 Luncheon Interval: The interval shall be of 40 minutes duration.

15.1.2 Tea Interval: The interval shall be of 20 minutes duration.

15.2 Law 15.8 - Tea interval- 9 wickets down

Law 15.8 shall apply.

In addition, the provisions of Law 15.8 as applicable to the tea interval shall also apply to the lunch interval.

15.3 Law 15.9 - Intervals for Drinks

The provisions of Law 15.9 shall be strictly observed except that under conditions of extreme heat the umpires may permit extra intervals for drinks.

An individual player may be given a drink either on the boundary edge or at the fall of a wicket, on the field, provided that no playing time is wasted. No other drinks shall be taken onto the field without the permission of the umpires. Any player taking drinks onto the field shall be dressed in proper cricket attire. (subject to the wearing of bibs – refer to the note in clause 2.2.3).

16 LAW 16 - START OF PLAY; CESSATION OF PLAY

Law 16 shall apply subject to the following:

16.1 Start and Cessation Times

The Home Board shall determine the hours of play, subject to there being 6 hours scheduled play per day (Pakistan, a minimum of 5.½ hours), and subject to:

16.1.1 Minimum Overs in the Day

Subject to clause 16.1.2 below:

- a) On days other than the last day, play shall continue on each day until the completion of a minimum target of 100 overs (or a minimum of 17 overs per hour) or the completion of the scheduled or rescheduled cessation time, which ever is the later but provided that play shall not continue for more than 30 minutes beyond the scheduled or rescheduled cessation time.

(permitted overtime). For the sake of clarity, if any of the minimum target number of overs have not been bowled at the completion of the permitted overtime, play shall cease upon completion of the over in progress. The overs not bowled shall not be made up on any subsequent day.

- b) On the last day, a minimum of 83 overs (or a minimum of 17 overs per hour) shall be bowled during the playing time other than the last hour of the match. If any of the minimum of 83 overs, or as recalculated, have not been bowled when one hour of the scheduled playing time remains, the last hour of the match shall be the hour immediately following the completion of these overs.

1.6.1.2 Reduction in minimum overs

Except in the last hour of the match, for which Law 16.6 makes provision, if play is suspended due to adverse weather or light or any other reason (other than normal intervals) for more than 1 hour on any day, the minimum number of overs shall be reduced by 1 over for each 3.52 minutes of the aggregate playing time lost. For the avoidance of doubt, the aggregate of 1 hour shall be inclusive of any time that may have been brought forward from previous days due to playing time lost on such previous days under clause 16.1.3 b. below.

16.1.3 Making Up Lost Time

- a) On The Day

Subject to weather and light, except in the last hour of the match, in the event of play being suspended for any reason other than normal intervals, the playing time on that day shall be extended by the amount of time lost up to a maximum of 1 hour. For the avoidance of doubt, the maximum of 1 hour shall be inclusive of any time that may have been added to the scheduled playing time due to playing time having been lost on previous days under clause 16.1.3 b. below.

- b) On Subsequent Days

If any time is lost and cannot be made up under clause 16.1.3 a., additional time up to a maximum of 30 minutes per day shall be added to the scheduled playing hours for the next day, and subsequent day(s) as required (to make up as much lost time as possible). Where appropriate this additional time shall be added prior to the scheduled start of the first session.

In circumstances where it is not possible to add this additional time prior to the scheduled start of the first session, the additional time may be added to the second and/or the third sessions (see also 16.1.4). When such additional time is added, the minimum overs for that day shall be increased by one over for each 3.52 minutes of additional time or part thereof.

- c) On the Last Day only

Clause 16.1.3 (a) applies. However, for the purposes of this clause, the definition of playing time shall exclude the last hour. No time is made up in respect of any interruptions that commence after the start of the last hour.

Should play be interrupted prior to the last hour being signalled, the playing time lost will be made up (subject to the maximum of 1 hour described in (a) above) with the previously scheduled time for the last hour being updated to reflect the time made up during this interruption.

In order to determine the minimum overs to be bowled prior to the last hour and the rescheduled starting time for the last hour, it is necessary to complete the template in Appendix 5.

16.1.4 Change of Intervals

- a) If play has been suspended for any reason other than normal intervals for 30 minutes or more prior to the commencement of the scheduled or rescheduled tea interval on that day, the tea interval shall be delayed for 1/2 hour.
- b) Notwithstanding the provisions of clause a above, the timings of intervals can be altered under Law 15.5 at any time on any day if playing time has been lost irrespective of whether the time has been lost on that day or on any previous days.

16.1.5 Change of Innings

Where there is a change of innings during a days play (except where the change of innings occurs at lunch or tea or when play is suspended for any reason) 2 overs will be deducted from the minimum number of overs to be bowled.

The over in progress at the end of an innings is regarded as a completed over for the purposes of determining the minimum number of remaining overs to be bowled in the day.

16.1.6 Last Hour

On the final day, if both captains (the batter at the wicket may act for their captain) accept that there is no prospect of either side achieving a victory, they may agree to finish the match after (a) the time for the commencement of the last hour has been reached OR (b) there are a minimum of 17 overs to be bowled, whichever is the later.

- 16.1.7 Notwithstanding any other provision, there shall be no further play on any day, other than the last day, if a wicket falls or a batsman retires or if the players have occasion to leave the field during the last minimum over within 2 minutes of the scheduled cessation time or thereafter. This shall also apply to the additional time permitted in order to complete the minimum over requirement for the day. If an over is interrupted in these circumstances stumps shall be drawn for the day and the over shall be completed on the resumption of play.

- 16.1.8 An over completed on resumption of a new day's play shall be disregarded in calculating minimum overs for that day.

16.1.9 Stumps Drawn

Except on the final day:

- a) In the event of play being suspended for any reason at or after the most recently scheduled or rescheduled cessation time, stumps shall be drawn upon play being suspended.
- b) In the event of the players already being off the field for a suspension of play at the most recently rescheduled cessation time, then stumps will be drawn at that time.

16.1.10 The scoreboard shall show:

- a) the total number of overs bowled with the ball currently in use: and
- b) the minimum number of overs remaining to be bowled in a day.

- 16.1.11 Penalties shall apply for slow over rates (refer to the ICC Code of Conduct).

16.2 Extra Time

The umpires may decide to play 30 minutes (a minimum of nine overs) extra time at the end of any day (other than the last day) if requested by either captain if, in the umpires' opinion, it would bring about a definite result on that day [this is in addition to the additional time provided for in Clause 16.1.3 above]. If the umpires do not believe a result can be achieved no extra time shall be allowed.

If it is decided to play such extra time on one or more of these days, the whole period shall be played out even though the possibility of finishing the match may have disappeared before the full period has expired.

Only the actual amount of playing time up to the maximum 30 minutes extra time by which play is extended on any day shall be deducted from the total number of hours of play remaining, and the match shall end earlier on the final day by the amount of time by which play was previously extended under this clause.

16.2.2 The umpires may decide to play 15 minutes (a minimum of four overs) extra time at the scheduled lunch or tea interval of any day if requested by either captain if, in the umpires' opinion, it would bring about a definite result in that session. If the umpires do not believe a result can be achieved no extra time shall be allowed.

If it is decided to play such extra time, the whole period shall be played out even though the possibility of finishing the match may have disappeared before the full period has expired.

Only the actual amount of playing time up to the maximum 15 minutes extra time by which play is extended on any day shall be deducted from the total number of hours of play remaining, and the following session of play shall be reduced by the amount of time by which play was previously extended under this clause.

For the avoidance of doubt, Law 15.8, as amended by Clause 15.2, shall still apply subsequent to the application of this clause, i.e. when 9 wickets are down following the extra 15 minutes. However, this clause shall not apply when Law 15.8, as amended by Clause 15.2, has already been applied, i.e. the 15 minutes shall not be added at the end of 30 minutes extra time.

16.3 Minimum Over Rates

The minimum over rate to be achieved in Test Matches will be 17 overs per hour.

The actual over rate will be calculated at the end of the match by the umpires and will be the average rate which is achieved by the fielding team across both of the batting team's innings.

In calculating the actual over rate for the match, allowances will be given as follows:

- 16.3.1 The time lost as a result of treatment given to a player by an authorised medical personnel on the field of play;
- 16.3.2 The time lost as a result of a player being required to leave the field as a result of a serious injury;
- 16.3.3 The time taken for all third umpire referrals and consultations and any umpire or player reviews;
- 16.3.4 The time lost as a result of time wasting by the batting side; and

- 16.3.5 The time lost due to all other circumstances that are beyond the control of the fielding side.
- 16.3.6 2 minutes per wicket taken, provided that such wicket results in the subsequent batsmen immediately commencing his innings. For the avoidance of any doubt, no time allowance will be given for the final wicket of an innings or where a wicket falls immediately prior to any interval;
- 16.3.7 4 minutes per drinks break taken (one per session).

In the event of any time allowances being granted to the fielding team under 16.3.4 above (time wasting by batting team), then such time shall be deducted from the allowances granted to such batting team in the determination of its over rate.

If a side is bowled out in 3½ hours or less (taking into account all of the time allowances set out above) in any particular innings, no account will be taken of the actual over rate in that innings when calculating the actual over rate at the end of the match.

17 LAW 17 - PRACTICE ON THE FIELD

Law 17 shall apply subject to the following:

17.1 Law 17.1 - Practice on the pitch or the rest of the square

- a) The use of the square for practice on any day of any match will be restricted to any netted practice area or bowling strips specifically prepared on the edge of the square for that purpose.
- b) Bowling practice on the bowling strips referred to in (a) above shall also be permitted during the interval (and change of innings if not the interval) unless the umpires consider that, in the prevailing conditions of ground and weather, it will be detrimental to the surface of the square.

17.2 Law 17.3 - Practice on the outfield between the call of play and the call of time

Law 17.3 shall apply save that Law 17.3 (b) (ii) shall be replaced with the following:

- c) There shall be no bowling or batting practice on the outfield. Bowling a ball, using a short run up to a player in the outfield is not to be regarded as bowling practice but shall be subject to the law.

18 LAW 18 - SCORING RUNS

Law 18 shall apply.

19 LAW 19 - BOUNDARIES

Law 19 shall apply subject to the following:

19.1 Law 19.1 - The boundary of the field of play

The boundary shall be a minimum of 55 yards (50.29 metres) and a maximum of 65 yards (59.44 metres) Distances shall be measured from the centre of the pitch to be used.

Any ground on which a Test or ODI International has been played prior to 1st July 1995 which cannot conform with these minimum dimensions shall be exempt from this playing condition. Any new ground must conform to these minimum dimensions.

19.2 Law 19.2 - Defining the boundary - boundary marking

The following shall apply in addition to Law 19.2:

All boundaries must be designated by a rope or similar object of a minimum standard as authorised by the ICC from time to time. Where appropriate the rope should be a required minimum distance (3 yards (2.74 metres) minimum) inside the perimeter fencing or advertising signs.

19.3 Law 19.3 - Scoring a boundary

The following shall be added to Law 19.3:

If an unauthorized person enters the playing arena and handles the ball, the umpire at the bowler's end shall be the sole judge of whether the boundary allowance should be scored or the ball be treated as still in play or called dead ball if a batter is liable to be out as a result of the unauthorized person handling the ball. See also Law 19.1 (c).

20 LAW 20 - LOST BALL

Law 20 shall apply.

21 LAW 21 - THE RESULT

Law 21 shall apply subject to the following:

21.1 Law 21.2 - A win-one innings match

Law 21.2 shall not apply

21.2 Law 21.8 - Correctness of result

Any query on the result of the match as defined in Laws 21.1, 21.3, 21.4, 21.5, 21.8 and 21.10 shall be resolved as soon as possible and a final decision made by the umpires at close of play.

Law 21.3 – Umpire (ICC Match Referee) awarding a match

Law 21.3 shall be replaced by the following:

- a) A match shall be lost by a side which either
 - i) concedes defeat or
 - ii) in the opinion of the ICC Match Referee refuses to play and the Referee shall award the match to the other side.
- b) If an umpire considers that an action by any players or players might constitute a refusal by either side to play then the umpires together shall inform the ICC Match Referee of this fact. The ICC Match Referee shall together with the umpires ascertain the cause of the action. If the ICC Match Referee, after due consultation with the umpires, then decides that this action does constitute a refusal to play by one side, he shall so inform the captain of that side. If the captain persists in the action, the Referee shall award the match in accordance with (a) (ii) above.*
- c) If action as in (b) above takes place after play has started and does not constitute a refusal to play
 - i) playing time lost shall be counted from the start of the action until play recommences, subject to Law 15.5 (Changing agreed times for intervals).
 - ii) the time for close of play on that day shall be extended by this length of time, subject to Law 3.9 (Suspension of play for adverse conditions of ground, weather or light) and the provisions of clause 16.

iii) if applicable, no overs shall be deducted during the last hour of the match solely on account of this time.

* N/B In addition to the consequences of any refusal to play prescribed under this clause, any such refusal, whether temporary or final, may result in disciplinary action being taken against the captain and the team responsible under the Code of Conduct.

21.3 Law 21.4 – Matches in which there is an agreement under Law 12.1(b)

Law 21.4 shall not apply.

22 LAW 22 - THE OVER

Law 22 shall apply subject to the addition of the following to Law 22.5:

22.1 Law 22.5 - Umpire miscounting

Whenever possible the third umpire shall liaise with the scorers and if possible inform the on-field umpires if the over has been miscounted.

23 LAW 23 - DEAD BALL

Law 23 shall apply subject to the addition of the following to Law 23.4.

23.1 Law 23.4 – Umpire calling and signalling ‘Dead Ball’

In a match where cameras are being used on or over the field of play (e.g. Spydercam), should a ball that has been hit by the batter make contact, while still in play, with the camera, its apparatus or its cable, either umpire shall call and signal ‘dead ball’. The ball shall not count as one of the over and no runs shall be scored. If the delivery was called a no ball it shall count and the no ball penalty applied. No other runs (including penalty runs) apart from the no ball penalty shall be scored.

Should a ball thrown by a fielder make contact with a camera on or over the field of play, its apparatus or its cable, either umpire shall call and signal dead ball. Unless this was already a no-ball or wide, the ball shall count as one of the over. All runs scored to that point shall count, plus the run in progress if the batters have already crossed.

24 LAW 24 - NO BALL

Law 24 shall apply subject to the following:

24.1 Law 24.1 - Mode of delivery

Law 24.1 (b) shall be replaced by the following:

The bowler may not deliver the ball underarm. If a bowler bowls a ball underarm the umpire shall call and signal no ball, and the ball is to be re-bowled overarm.

24.2 Fair Delivery - the feet

Law 24.5 shall apply, subject to the final paragraph being replaced by the following:

If the bowler's end umpire is satisfied that any of these three conditions have not been met, he shall call and signal No ball.

25 LAW 25 - WIDE BALL

25.1 Law 25.1 - Judging a Wide

Law 25 shall apply with the following addition to Law 25.1 (Judging a wide):

For bowlers attempting to utilise the rough outside a batter's leg stump, not necessarily as a negative tactic, the strict limited over wide interpretation shall be applied.

For bowlers whom umpires consider to be bowling down the leg side as a negative tactic, the strict limited over wide interpretation shall be applied.

26 LAW 26 - BYE AND LEG BYE

Law 26 shall apply.

27 LAW 27 - APPEALS

Law 27 shall apply.

28 LAW 28 - THE WICKET IS DOWN

Law 28 shall apply.

29 LAW 29 - BATTER OUT OF HER GROUND

The following shall apply in addition to Law 29:

If the running batter has grounded any part of her foot behind the popping crease, then any subsequent loss of contact with the ground of her person or bat, during her continuing forward momentum, should not be interpreted as being 'out of her ground'.

30 LAW 30 - BOWLED

Law 30 shall apply.

31 LAW 31 - TIMED OUT

Law 31 shall apply.

Refer also to clause 42.9 (Law 42.10).

32 LAW 32 - CAUGHT

Law 32 shall apply.

33 LAW 33 - HANDLED THE BALL

Law 33 shall apply.

34 LAW 34 - HIT THE BALL TWICE

Law 34 shall apply.

35 LAW 35 - HIT WICKET

Law 35 shall apply.

36 LAW 36 - LEG BEFORE WICKET

Law 36 shall apply.

37 LAW 37 - OBSTRUCTING THE FIELD

Law 37 shall apply. For the avoidance of doubt, if an umpire feels that a batter, in running between the wickets, has significantly changed his direction without probable cause and thereby obstructed a fielder's attempt to effect a run out, the batter should, on appeal, be given out, obstructing the field. It shall not be relevant whether a run out would have occurred or not.

If the change of direction involves the batter crossing the pitch, Law 42.14 shall also apply.

38 LAW 38 - RUN OUT

Law 38 shall apply.

39 LAW 39 - STUMPED

Law 39 shall apply.

40 LAW 40 - THE WICKET-KEEPER

Law 40 shall apply.

41 LAW 41 - THE FIELDER

Law 41 shall apply subject to the following:

41.1 Law 41.1 - Protective equipment

In addition to Law 41.1:

The exchanging of protective equipment between members of the fielding side on the field shall be permitted provided that the umpires do not consider that it constitutes a waste of playing time.

42 LAW 42 - FAIR AND UNFAIR PLAY**42.1 Law 42.3 - The match ball - changing its condition**

Law 42.3 shall apply, subject to the following:

Law 42.3 (d) and (e) shall be replaced with the following:

If the umpires together agree that the deterioration of the ball is inconsistent with the use it has received, they shall consider that there has been a contravention of this Law. They shall then decide together whether they can identify the player(s) responsible for such conduct.

42.1.1 If it is possible to identify the player(s) responsible:

- a) Change the ball forthwith. The batter at the wicket shall choose the replacement ball from a selection of six other balls of various degrees of usage (including a new ball) and of the same brand as the ball in use prior to the contravention.

Additionally the bowler's end umpire shall:

- b) Award 5 penalty runs to the batting side.
- c) Inform the captain of the fielding side of the reason for the action taken.
- d) Inform the captain of the batting side as soon as practicable of what has occurred.

- e) Together with the other umpire report the incident to the ICC Match Referee who shall take action as is appropriate against the player(s) responsible for the conduct under the ICC Code of Conduct.

42.1.2 If it is not possible to identify the player(s) responsible:

- a) Change the ball forthwith. The umpire shall choose the replacement ball for one of similar wear and of the same brand as the ball in use prior to the contravention.
- b) The bowler's end umpire shall issue the captain with a first and final warning, and
- c) Advise her should there be any further incident by that team during the remainder of the match, steps 42.1.1 a) to e) above will be adopted, with the captain deemed under e) to be the player responsible.

42.2 Law 42.4 - Deliberate attempt to distract striker

Law 42.4 shall apply subject to the following:

In addition, the umpires shall report the incident to the ICC Match Referee under the ICC Code of Conduct.

42.3 Law 42.5 - Deliberate distraction or obstruction of batter

Law 42.5 shall apply subject to the following:

In addition, the umpires shall report the incident to the ICC Match Referee under the ICC Code of Conduct.

42.4 Law 42.6 - Dangerous and Unfair Bowling

42.4.1 Law 42.6 (a) - The Bowling of Fast Short Pitched Balls

Law 42.6 (a) shall be replaced by the following:

- a) A bowler shall be limited to two fast short-pitched deliveries per over.
- b) A fast short-pitched delivery is defined as a ball, which passes or would have passed above the shoulder height of the striker standing upright at the popping crease.
- c) The umpire at the bowlers end shall advise the bowler and the batter on strike when each fast short pitched delivery has been bowled.
- d) In addition, for the purpose of this regulation and subject to Clause 42.4.1 (f) below, a ball that passes above head height of the batter, that prevents her from being able to hit it with her bat by means of a normal cricket stroke shall be called a wide.
- e) For the avoidance of doubt any fast short pitched delivery that is called a wide under this playing condition shall also count as one of the allowable short pitched deliveries in that over.
- f) In the event of a bowler bowling more than two fast short-pitched deliveries in an over as defined in Clause 42.4.1 (b) above, the umpire at the bowlers end shall call and signal no ball on each occasion. A differential signal shall be used to signify a fast short pitched delivery. The umpire shall call and signal 'no ball' and then tap the head with the other hand.

- g) If a bowler delivers a third fast short pitched ball in an over, the umpire, after the call of no ball and when the ball is dead, shall caution the bowler, inform the other umpire, the captain of the fielding side and the batter at the wicket of what has occurred. This caution shall apply throughout the innings.
- h) If there is a second instance of the bowler being no balled in the innings for bowling more than two fast short pitched deliveries in an over, the umpire shall advise the bowler that this is her final warning for the innings.
- i) Should there be any further instance by the same bowler in that innings, the umpire shall call and signal no ball and when the ball is dead direct the captain to take the bowler off forthwith.
If necessary, the over shall be completed by another bowler, who shall neither have bowled the previous over, or part thereof, nor be allowed to bowl the next over, or part thereof.
- j) The bowler thus taken off shall not be allowed to bowl again in that innings.
- k) The umpire will report the occurrence to the other umpire, the batter at the wicket and as soon as possible to the captain of the batting side.
- l) The umpires will then report the matter to the ICC Match Referee who shall take such action as is considered appropriate against the captain and the bowler concerned. (Refer also to Law 42.1 Fair and Unfair Play - Responsibility of the Captains).
The above is not a substitute for Clause 42.5 below which umpires are able to apply at any time.

42.4.2 Law 42.6 (b) Bowling of High Full Pitched Balls

Law 42.6 (b) shall be replaced by the following:

- a) Any delivery, which passes or would have passed on the full above waist height of the striker standing upright at the popping crease is deemed unfair, whether or not it is likely to inflict physical injury on the striker.
- b) In the event of a bowler bowling a high full pitched ball as defined in Clause 42.4.2 (a) above, the umpire at the bowler's end shall call and signal no ball.
If, in the opinion of the umpire, such a delivery is considered likely to inflict physical injury on the batter, the umpire at the bowler's end shall, in addition to calling and signalling no ball, when the ball is dead, caution the bowler and issue a first and final warning. The umpire shall inform the other umpire, the captain of the fielding side and the batter at the wicket of what has occurred.
- c) Should there be any further instance (where a high full pitched ball is bowled and is considered likely to inflict physical injury on the batter) by the same bowler in that innings, the umpire shall, in addition to calling and signalling no ball, when the ball is dead, direct the captain to take the bowler off forthwith. If necessary, the over shall be completed by another bowler, who shall neither have bowled the previous over, or part thereof, nor be allowed to bowl the next over, or part thereof.

- d) The bowler thus taken off shall not be allowed to bowl again in that innings.
- e) The umpire will report the occurrence to the other umpire, the batter at the wicket and as soon as possible to the captain of the batting side.
- f) The umpires will then report the matter to the ICC Match Referee who shall take such action as is considered appropriate against the captain and the bowler concerned. (Refer also to Law 42.1 Fair and Unfair Play - Responsibility of the Captains.)

42.5 Law 42.7 - Dangerous and Unfair Bowling - Action by the umpire

Law 42.7 shall be replaced by the following:

Regardless of any action taken by the umpire as a result of a breach of Clauses 42.4.1, 42.4.2 and 42.6 the following shall apply at any time during the match.

42.5.1 The bowling of fast short pitched balls is unfair if in the opinion of the umpire at the bowler's end they consider that by their repetition and taking into account their length, height and direction, they are likely to inflict physical injury on the striker, irrespective of the protective clothing and equipment she may be wearing. The relative skill of the striker shall also be taken into consideration.

42.5.2 In the event of such unfair bowling, the umpire at the bowler's end shall adopt the following procedure:

- a) In the first instance the umpire shall call and signal no ball, caution the bowler and inform the other umpire, the captain of the fielding side and the batter of what has occurred.
- b) If this caution is ineffective, they shall repeat the above procedure and indicate to the bowler that this is a final warning.
- c) Both the above caution and final warning shall continue to apply even though the bowler may later change ends.
- d) Should there be any further instance by the same bowler in that innings, the umpire shall call and signal no ball and when the ball is dead direct the captain to take the bowler off forthwith.

If necessary, the over shall be completed by another bowler, who shall neither have bowled the previous over, or part thereof, nor be allowed to bowl the next over, or part thereof. See Law 22.8. (Bowler Incapacitated or Suspended during an Over).
- e) The bowler thus taken off shall not be able to bowl again in that innings.
- f) The umpire will report the occurrence to the other umpire, the batter at the wicket and as soon as possible to the captain of the batting side.
- g) The umpires will then report the matter to the ICC Match Referee who shall take such action as is considered appropriate against the captain and the bowler concerned. (Refer also to Law 42.1 Fair and Unfair Play - Responsibility of the Captains.)

42.6 Law 42.8 - Deliberate bowling of High Full Pitched Balls

Law 42.8 shall be replaced by the following:

If the umpire considers that a high full pitch delivery which is deemed unfair as defined in Clause 42.4.2 was deliberately bowled, then the caution and warning process shall be dispensed with.

The umpire at the bowlers end shall:

- 42.6.1 Call and signal no ball.
- 42.6.2 When the ball is dead, direct the captain to take the bowler off forthwith.
- 42.6.3 Not allow the bowler to bowl again in that innings.
- 42.6.4 Ensure that the over is completed by another bowler, provided that the bowler does not bowl two overs or part thereof consecutively.
- 42.6.5 Report the occurrence to the other umpire, to the captain of the batting side and the ICC Match Referee who shall take such action as is considered appropriate against the captain and the bowler concerned. (Refer also to Law 42.1 Fair and Unfair Play Responsibility of the Captains).

42.7 Action by the umpires for dangerous and unfair Bowling

Should the umpires initiate the caution and warning procedures set out in Clauses 42.4.1, 42.4.2, 42.5 and 42.6 such cautions and warnings are not to be cumulative.

42.8 Law 42.9 - Time Wasting by the Fielding Side

Law 42.9 shall apply subject to Law 42.9 (b) being replaced by the following:

- 42.8.1 If there is any further waste of time in that innings, by any member of the fielding side the umpire shall:
 - a) Call and signal dead ball if necessary, and;
 - b) Award 5 penalty runs to the batting side (see Law 42.17).
 - c) Inform the other umpire, the batter at the wicket and as soon as possible the captain of the batting side of what has occurred.
 - d) Report the occurrence to the ICC Match Referee who shall take such action as is considered appropriate against the captain and the team concerned under the ICC Code of Conduct.

42.9 Law 42.10 - Batter Wasting Time

Law 42.10 shall apply, subject to the following:

If the incoming batter is not in position to take guard or her partner is not ready to receive the next ball within 2 minutes of the fall of the previous wicket, the action should be regarded by the umpires as time wasting and the provisions of Law 42.10 shall apply.

In addition, the umpires will report the incident to the ICC Match Referee under the ICC Code of Conduct

42.10 Law 42.14 Batter damaging the pitch

Law 42.14 shall apply.

See also clause 37 above.

42.11 Law 42.15 – Bowler attempting to run out non-striker before delivery

Law 42.15 shall be replaced by the following:

The bowler is permitted, before releasing the ball and provided he has not completed his usual delivery swing, to attempt to run out the non-striker. Whether the attempt is successful or not, the ball shall not count as one of the over. If the bowler fails in an attempt to run out the non-striker, the umpire shall call and signal Dead ball as soon as possible.

42.12 Use of Electronic Communications Equipment

The use of electronic communication devices and equipment of any kind to communicate with players on the field of play shall not be permitted.

APPENDIX 1

All penalty runs in the Laws of Cricket (2000 Code – 5th Edition 2013) now apply in International Cricket. Some penalty runs can be referred to the ICC Match Referee for further action if necessary.

APPENDIX 2

Third Umpire TV Replay System – Playing Conditions

1 GENERAL

- a) The Home Board shall endeavour to broadcast all Test Matches played in its country.
- b) Where matches are broadcast the camera specifications set out in Appendix 3 shall be mandatory as a minimum requirement.
- c) Where matches are not broadcast, countries are encouraged to implement the camera specifications as outlined in Appendix 4.
- d) For televised matches, the Home Board will ensure a separate room is provided for the third umpire and that he has access to a television monitor and direct sound link with the television control unit director to facilitate as many replays as is necessary to assist him in making a decision.
- e) For televised matches, in the circumstances detailed in Clauses 2, 4 and 5 hereunder, the on-field umpire has the discretion whether or not to refer the appeal to the third umpire or, in the case of paragraph 3, 5 and 6 to consult with the third umpire before making his decision and should take a common sense approach. Players may not appeal to the umpire to use the replay system - breach of this provision would constitute dissent and the player could be liable for discipline under the ICC Code of Conduct.
- f) For televised matches, the third umpire shall call for as many replays from any camera angle as is necessary to reach a decision. As a guide, a decision should be made within 30 seconds whenever possible, but the third umpire shall have discretion to take more time in order to finalise a decision.
- g) The third umpire shall only have access to TV replays for the provisions of paragraphs 2, 3, 4, 5 and 6 below. Other technology which may be in use by the broadcaster for broadcast purposes (Hot Spot, ball tracking, Snicko) shall not be permitted.

2 RUN OUT, STUMPING AND HIT WICKET DECISIONS

- a) For televised matches, the on-field umpire shall be entitled to refer an appeal for a run-out, stumping or hit wicket to the third umpire.
- b) For televised matches, an on-field umpire wishing to refer a decision to the third umpire shall signal to the third umpire by making the shape of a TV screen with their hands.
- c) For televised matches, if the third umpire decides the batter is out a red light is displayed; a green light means not-out. Should the third umpire be temporarily unable to respond, a white light (where available) will remain illuminated throughout the period of interruption to signify to the on-field umpires that the TV replay system is temporarily unavailable, in which case the decision will be taken by the on-field umpire. (As an alternative to the red/green light system and where available, the big replay screen may be used for the purpose of conveying the third umpire's decision).
- d) For televised matches, when reviewing the TV replay(s) the third umpire shall first check the fairness of the delivery (foot fault, bowler breaking the wicket, waist high full tosses, bouncers above shoulder height). Additionally if the third umpire finds the batter is out by another mode of dismissal (excluding LBW), or not out by any mode of dismissal (excluding LBW), he shall notify the on-field umpire so that the correct decision is made.

3 CAUGHT DECISIONS

For televised matches, the on-field umpire shall be entitled to refer an appeal for a caught decision to the third umpire in the following circumstances:

3.1 Clean Catches

- a) Should the bowler's end umpire be unable to decide whether or not a catch was taken cleanly, they shall first consult with the square leg umpire.
- b) Should both umpires be unable to make a decision, they may consult by two-way radio with the 3rd umpire. Following such consultation, the final decision will be made and given by the bowler's end umpire, who will take into account the on-field umpires' initial views and any other advice received from the 3rd umpire.
- c) The third umpire has to determine whether the batter has been caught. However, when reviewing the television replay(s), the third umpire shall first check the fairness of the delivery (foot fault, bowler breaking the wicket, waist high full tosses, bouncers above shoulder height). Additionally, if it is clear to the third umpire that the batter is out by another mode of dismissal (excluding LBW), or not out by any mode of dismissal (excluding LBW), he shall notify the on-field umpire so that the correct decision is made.
- d) the third umpire shall communicate their decision by the system as in paragraph 2.3.

3.2 Bump Ball

- a) Should the bowler's end umpire be unable to decide whether a catch was taken from a bump ball or not, they shall first consult with the square leg umpire.
- b) Should both on-field umpires be unable to make a decision, the bowler's end umpire shall be entitled to refer the decision to the third umpire to review a TV replay(s) of the batter's stroke as in Clause 2 (b).
- c) The third umpire has to determine whether the ball was a bump ball or not. However, when reviewing the television replay(s), the third umpire shall first check the fairness of the delivery (foot fault and bowler breaking the wicket). Additionally, if it is clear to the third umpire that the batter is out by another mode of dismissal (excluding LBW), or not out by any mode of dismissal (excluding LBW), he shall notify the on-field umpire so that the correct decision is made.
- d) The third umpire shall communicate their decision by the system as in Clause 2 (c).

4 BOUNDARY DECISIONS

- 4.1 For televised matches, the on-field umpire shall be entitled to refer to the third umpire for a decision about whether the fielder had any part of her person in contact with the ball when she touched the boundary or when she had any part of her person grounded beyond the boundary or whether a four or six had been scored. A decision is to be made immediately and cannot be changed thereafter.
- 4.2 For televised matches, an on-field umpire wishing the assistance of the third umpire in this circumstance shall communicate with the third umpire by use of a two-way radio and the third umpire will convey their decision to the on-field umpire by this method.

- 4.3 For televised matches, the third umpire may initiate contact with the on-field umpire by two-way radio if TV coverage shows a boundary line infringement or incident that appears not to have been acted upon by the on-field umpires.

5 OBSTRUCTING THE FIELD

- a) Following an appeal from the fielding side, the on-field umpire shall be entitled to consult with the third umpire if he feels that the batter, in running between the wickets, may have significantly changed her direction (refer clause 37).
- b) Such consultation shall be initiated by the on-field umpire and will be done to help him decide the extent of any change in direction and whether the obstruction was wilful or not.
- c) Following such consultation with the third umpire, the final decision shall be indicated in the normal fashion by the relevant on-field umpire.

6 BATTER RUNNING TO THE SAME END

- 6.1 For televised matches, in the event of both batters running to the same end and the umpires are uncertain over which batter made her ground first, the on-field umpire may refer the decision to the third umpire.
- 6.2 The procedure in Clause 4.2 shall apply.

7 NO BALLS

If the on-field umpire is uncertain as the fairness of the delivery, he shall be entitled to request the batter to delay leaving the field and to check the fairness of the delivery (foot-fault, bowler breaking the wicket, waist high full tosses, bouncers above shoulder height only) with the third umpire. Consultation with the third umpire shall be by way of two way radio. If the delivery was not a fair delivery the on-field umpire shall indicate that the batter is not-out and signal no-ball. For the avoidance of doubt, the third umpire shall apply clause 24.2 when deciding whether a no-ball should have been called.

APPENDIX 3

Generic Camera Layout - Basic TV Coverage

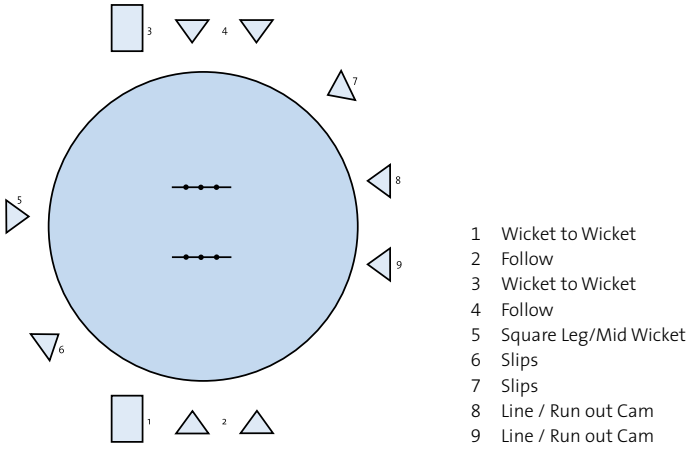

APPENDIX 4

Generic Camera Layout - Third Umpire Coverage

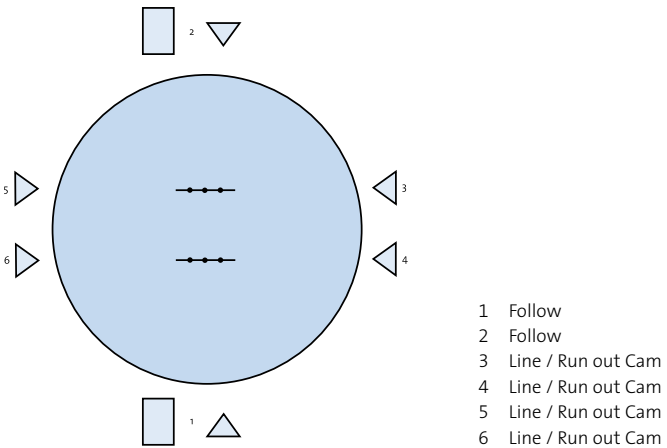

APPENDIX 5

Calculation Template for Last Day of Test Match

This template applies to any interruption on the last day which causes a loss in actual playing time, (i.e. an interruption longer than the amount of extra time available) and where play resumes after the scheduled tea interval.

Where play resumes prior to tea, then the calculation of overs remaining in the day is performed as per Days 1-4, with the scheduled time for the last hour affected only by the adding of any extra time.

Lines A, B, C, D and E should be completed at the start of an interruption on the final day. If play resumes without any lost playing time, or prior to the tea interval, then this sheet can be discarded.

Once the length of interruption exceeds D and actual playing time is lost, then line F can be completed

Lines G and H can be completed immediately if the interruption starts after tea, otherwise as soon as the interruption includes the tea interval.

- A Start of interruption _____
- B Minimum overs remaining before start of last hour as at time A
(See Note 1) _____
- C Time required to bowl minimum overs @ 3.52 mins per over (B x 3.52) _____
- D Extra time available as at time A _____
- E Scheduled time for last hour as at time A _____
- F Rescheduled time for last hour (Time basis) (D + E) _____
- G Length of intervals covered by interruption:
enter 40 (lunch), 20 (tea), 60 (both) or 0 (neither) _____
- H Rescheduled time for last hour (Overs basis) (A + C + D + G) _____
- I Later of F and H above _____
- J Time play resumes _____

Case A: If J is earlier than I, play resumes prior to the last hour

K Minutes playing time lost ($J - A - D - G$) _____

L Overs lost @ 3.52 mins per over (see Note 2)

M Minimum overs before start of last hour ($B - L$) (See Note 1) _____

The last hour then starts at the later of the time in Line F
and the completion of the overs in Line M _____

Case B: If J is not earlier than I, play resumes in the last hour

K Time for last hour to finish (I plus 60 minutes) _____

L Minutes remaining in last hour ($K - J$) _____

M Overs remaining in last hour ($L / 3.52$ mins or part thereof)
(See Note 1) _____

Note 1: If an interruption occurs part-way through an over, in Row B enter the number of full overs remaining, ignoring the part over. Then in Row M, add back the part over to the minimum overs to be bowled on resumption.

Note 2: The actual overs lost for a given interruption will also reflect any earlier interruptions in the day, so that one over is lost in the day for each full 3.52 minutes of aggregated playing time lost. For example, 10 minutes loses 2 overs, but another 10 minute delay loses 5 overs.

WOMEN'S **ONE-DAY INTERNATIONAL** PLAYING CONDITIONS

WOMEN'S ONE-DAY INTERNATIONAL PLAYING CONDITIONS

These playing conditions are applicable to all ODI matches from 1st October 2013 and supersede the previous version dated 30 April 2013. Included in this version are amendments to clauses 1.3, 2.2.2, 17.1, 17.2, 19.1, 19.3, 23.1, 42.1, 42.1.1, Appendices 3 and 7, and new clauses 8.2, 12.1.3, 24.3, 42.1.2 and Appendices 2 and 8.

Except as varied hereunder, the Laws of Cricket (2000 Code 5th Edition - 2013) shall apply.

Note: All references to 'Governing Body' within the Laws of Cricket shall be replaced by 'ICC Match Referee'. The ICC Match Referee may or may not be present at the match.

1 LAW 1 - THE PLAYERS

1.1 Law 1.1 - Number of Players

Law 1.1 shall be replaced by the following:

A match is played between two sides. Each side shall consist of 11 players, one of whom shall be captain.

1.2 Law 1.2 - Nomination of Players

Law 1.2 shall be replaced by the following:

- 1.2.1 Each captain shall nominate 11 players plus a maximum of 4 substitute fielders in writing to the ICC Match Referee before the toss. No player (member of the playing eleven) may be changed after the nomination without the consent of the opposing captain.
- 1.2.2 Only those nominated as substitute fielders shall be entitled to act as substitute fielders during the match, unless the match referee, in exceptional circumstances, allows subsequent additions.
- 1.2.3 All those nominated including those nominated as substitute fielders, must be eligible to play for that particular team and by such nomination the nominees shall warrant that they are so eligible.
- 1.2.4 In addition, by their nomination, the nominees shall be deemed to have agreed to abide by all the applicable ICC Regulations pertaining to international cricket and in particular, the Clothing and Equipment Regulations, the Code of Conduct for Players and Player Support Personnel (hereafter referred to as the ICC Code of Conduct), the Anti-Racism Code for Players and Player Support Personnel, the Anti-Doping Code and the Anti-Corruption Code.

1.3 Law 1.3 – Captain

The following shall apply in addition to Law 1.3 (a):

The deputy must be one of the nominated members of the playing eleven.

Each Member Board must nominate its 'ODI Team Captain' to the ICC when appointed.

If the 'ODI Team Captain' is not participating in a series, the relevant Home Board must nominate a replacement 'ODI Team Captain' for the series. The Home Board shall advise the series Referee.

If the 'ODI Team Captain' plays in a match without being the nominated captain for that match, she will be deemed to be the captain should any penalties be applied for over rate breaches under the Code of Conduct

2 LAW 2 - SUBSTITUTES AND RUNNERS, BATTER OR FIELDER LEAVING THE FIELD, BATTER RETIRING, BATTER COMMENCING INNINGS

Law 2 shall apply subject to the following:

2.1 Law 2.1 Substitutes and Runners

Law 2.1 (a) (ii), 2.7 and 2.8 shall not apply. A runner for a batter when batting is not permitted.

Law 2.1 (b) shall be amended as follows:

The umpires shall have discretion to allow, for other wholly acceptable reasons, a substitute fielder to act for a nominated player. at the start of the match, or at any subsequent time.

2.2 Law 2.5 - Fielder absent or leaving the field

Law 2.5 shall be replaced by the following:

If a fielder fails to take the field with her side at the start of the match or at any later time, or leaves the field during a session of play, the umpire shall be informed of the reason for her absence, and she shall not thereafter come on to the field during a session of play without the consent of the umpire. (See Law 2.6 as modified). The umpire shall give such consent as soon as practicable.

If the player is absent from the field for longer than 8 minutes:

2.2.1 the player shall not be permitted to bowl in that innings after her return until she has been on the field for at least that length of playing time for which she was absent.

2.2.2 the player shall not be permitted to bat unless or until, in the aggregate, she has returned to the field and/or her side's innings has been in progress for at least that length of playing time for which she has been absent or, if earlier, when her side has lost five wickets.

The restriction in Clauses 2.1.1 and 2.1.2 above shall not apply if the player has suffered an external blow (as opposed to an internal injury such as a pulled muscle) whilst participating earlier in the match and consequently been forced to leave the field. Nor shall it apply if the player has been absent for very exceptional and wholly acceptable reasons (other than injury or illness).

In the event of a batter or a fielder already being off the field at the commencement of an interruption in play through ground, weather or light conditions or for other exceptional circumstances, she shall be allowed to count any such stoppage time as playing time, provided that she personally informs the umpires when she is fit enough to take the field had play been in progress. Similarly, if at the commencement of an interruption in play through ground, weather or light conditions or for other exceptional circumstances, a player is on the field but still has some unexpired penalty time remaining from a previous absence, he shall automatically be allowed to count any such stoppage time as playing time.

2.2.3 Substitute fielders shall only be permitted in cases of injury, illness or other wholly acceptable reasons. 'Wholly acceptable reasons' should be limited to extreme circumstances and should not include what is commonly referred to as a 'comfort break'.

Note: Squad members of the fielding team who are not playing in the match and who are not acting as substitute fielders shall be required to wear a team training bib whilst on the playing area (including the area between the boundary and the perimeter fencing).

3 LAW 3 - THE UMPIRES**3.1 Law 3.1 - Appointment and attendance**

Law 3.1 shall be replaced by the following:

The following rules for the selection and appointment of ODI umpires shall be followed as far as it is practicable to do so:

- 3.1.1 Depending on the nature of the tournament, the Home Board shall appoint ICC approved umpires for on-field and third umpire duties. For televised matches the responsibility of the third umpire will be to act as an emergency umpire and officiate in regard to TV replays. For non-televised matches, the responsibility of the third umpire will be to act as an emergency umpire and carry out the tasks as prescribed for the third and fourth umpires (note: a fourth umpire is not required for international women's matches).
- 3.1.2 The umpires shall be present at the ground at least 90 minutes before the scheduled start of play.
- 3.1.3 ICC shall appoint a match referee (ICC Match Referee) who may or may not be present at the ground.
- 3.1.4 Neither team will have a right of objection to an umpire or match referee's appointment.

3.2 Third Umpire/TV Replays

The playing conditions set out in Appendix 7 shall apply

3.3 Law 3.2 - Change of umpire

The following shall apply in place of Law 3.2:

- 3.3.1 An umpire shall not be changed during the match, other than in exceptional circumstances, unless they are injured or ill.

3.4 Law 3.4 - To inform captains and scorers

The following shall apply in addition to Law 3.4 (i):

The host country may provide for the ringing of a bell, which shall be rung 5 minutes before the termination of an interval, when the umpires shall go to the wickets. The host country shall inform the ICC Match Referee (if one is present and on duty at the ground) and the visiting country at the start of the tour that this practice is to be adopted.

3.5 Law 3.8 - Fitness for play and Law 3.9 - Suspension of play in dangerous or unreasonable conditions.

- 3.5.1 The safety of all persons within the ground is of paramount importance to the ICC. In the event that any threatening circumstance, whether actual or perceived, comes to the attention of any umpire (including for example weather, pitch invasions, act of God, etc., see also 3.5.4 and 3.5.5 below) then the players and officials should immediately be asked to leave the field of play in a safe and orderly manner and to relocate to a secure and safe area (depending on each particular threat) pending the satisfactory passing or resolution of such threat or risk to the reasonable satisfaction of the umpires, ICC Match Referee, the head of the relevant ground authority, the head of ground security and/or the police as the circumstances may require. See also clause 3.6 below.

Laws 3.8 & 3.9 shall be replaced by:

- 3.5.2 The umpires shall be the final judges of the fitness of the ground, weather and light for play. See clause 3.5.3 below and Law 7.2 (Fitness of the pitch for play).
- 3.5.3 Suspension of play for adverse conditions of ground, weather or light
- a) (i) All references to ground include the pitch. See Law 7.1 (Area of pitch).
 - b) If at any time the umpires together agree that the conditions of ground, weather or light are so bad that there is obvious and foreseeable risk to the safety of any player or umpire, so that it would be unreasonable or dangerous for play to take place, then they shall immediately suspend play, or not allow play to commence or to restart. The decision as to whether conditions are so bad as to warrant such action is one for the umpires alone to make.

The fact that the grass and the ball are wet and slippery does not warrant the ground conditions being regarded as unreasonable or dangerous. If the umpires consider the ground is so wet or slippery as to deprive the bowler of a reasonable foothold, the fielders of the power of free movement, or the batsmen of the ability to play their strokes or to run between the wickets, then these conditions shall be regarded as so bad that it would be unreasonable for play to take place.

The Umpires shall disregard any shadow on the pitch from the stadium or from any permanent object on the ground.
- c) When there is a suspension of play it is the responsibility of the umpires to monitor the conditions. They shall make inspections as often as appropriate, unaccompanied by any of the players or officials. Immediately the umpires together agree that conditions are suitable for play they shall call upon the players to resume the game.
 - d) If play is in progress up to the start of an agreed interval then it will resume after the interval unless the umpires together agree that the conditions of ground, weather or light are so bad that there is obvious and foreseeable risk to the safety of any player or umpire, so that it would be unreasonable or dangerous for play to take place.
- 3.5.4 Play may be suspended due to safety and security concerns by the umpires on the advice of the ICC Match Referee (if one is present and on duty at the match), the head of the relevant ground authority, the head of ground security or the police.
- 3.5.5 Where play is suspended under Clause 3.5.4 above the decision to abandon or resume play shall be the responsibility of the ICC Match Referee (or umpires if no match referee is present and on duty at the match) who shall act only after consultation with the head of ground security and the police.

3.6 Light Meters

- 3.6.1 It is the responsibility of each Home Board to supply light meters to all umpires standing in international matches in accordance herewith.
- a) All light meters shall be uniformly calibrated.

- b) The umpires shall be entitled to use light meter readings as a guideline for determining whether the light is fit for play in accordance with the criteria set out in clause 3.5.3 (b) above.
- c) Light meter readings may accordingly be used by the umpires:
- d) To determine whether there has been at any stage a deterioration or improvement in the light.
- e) As benchmarks for the remainder of a stoppage, match and/or series/event.

3.7 Use of artificial lights

If in the opinion of the umpires, natural light is deteriorating to an unfit level, they shall authorize the ground authorities to use the available artificial lighting so that the match can continue in acceptable conditions.

In the event of power failure or lights malfunction, the existing provisions relating to the delay or interruption of play due to bad weather or light shall apply.

3.8 Day Night matches

3.8.1 Pads and players' and umpires' clothing shall be coloured.

3.8.2 Sight screens will be black

3.9 Advertising on grounds, perimeter boards and sightscreens

3.9.1 Advertising on grounds

The logos on outfields are to be positioned as follows:

- a) Behind the stumps – a minimum of 25.15 yards (23 meters) from the stumps.
- b) Midwicket/cover area – no advertising to be positioned within the 25.15 yard (23 meters) circle.

Note: Advertising closer to the stumps as set out above which is required to meet 3D requirements for broadcasters may be permitted, subject to prior ICC approval having been obtained.

3.9.2 Perimeter Boards

- a) Advertising on perimeter boards placed in front of the sightscreens is permitted save that the predominant colour of such advertising shall be of a contrasting colour to that of the ball.
- b) Advertising on perimeter boards behind the stumps at both ends shall not contain moving, flashing or flickering images and operators should ensure that the images are only changed or moved at a time that will not be distracting to the players or the umpires.
- c) In addition, the brightness of any electronic images shall be set at a level so that it is not a distraction to the players or umpires.

3.9.3 Sightscreens

- a) Sightscreens shall be provided at both ends of all grounds.
- b) Advertising shall be permitted on the sightscreen behind the striker, providing it is removed for the subsequent over from that end.

- c) Such advertising shall not contain flashing or flickering images and particular care should be taken by the operators that the advertising is not changed at a time which is distracting to the umpire.

4 LAW 4 - THE SCORERS

Law 4 shall apply.

5 LAW 5 - THE BALL

5.1 Law 5.2 - Approval and control of balls

Law 5.2 shall be replaced by the following:

The Home Board shall provide the best available high quality cricket balls (e.g. Kookaburra 'Turf' or its equivalent) and spare used balls for changing during a match, which shall also be of the same brand. Note: The Home Board shall be required to advise the visiting Board of the brand of ball to be used in the match(es) at least 30 days prior to the start of the match(es).

The fielding captain or her nominee may select the ball with which she wishes to bowl from the supply provided by the Home Board. The third umpire shall take a box containing at least 6 new balls to the dressing room and supervise the selection of the ball.

The umpires shall retain possession of the match ball(s) throughout the duration of the match when play is not actually taking place. During play umpires shall periodically and irregularly inspect the condition of the ball and shall retain possession of it at the fall of a wicket, a drinks interval, or any other disruption in play. Where day/night matches are scheduled in a series white balls will be used in all matches (including day matches). Each fielding team shall have one new ball for its innings.

5.2 Law 5.4 - New ball in a match of more than one day's duration

Law 5.4 shall not apply:

5.3 Law 5.5 - Ball lost or becoming unfit for play

Law 5.5 shall be replaced by the following:

- 5.3.1 In the event of a ball during play being lost or in the opinion of the umpires, being unfit for play through normal use, the umpires shall allow it to be replaced by one that in their opinion has had similar amount of wear.
- 5.3.2 In the event of the ball becoming wet and soggy as a result of play continuing in inclement weather or it being affected by dew, and in the opinion of the umpires being unfit for play, the ball may be replaced for a ball that has similar amount of wear, even though it has not gone out of shape.
- 5.3.3 If the ball is to be replaced, the umpire shall inform the batter and the fielding captain. Either the batter or bowler may raise the matter with the umpires and the umpires' decision as to a replacement or otherwise will be final.

5.4 Law 5.6 - Specifications

Law 5.6 (i) shall apply.

6 LAW 6 - THE BAT

The following shall apply in addition to Law 6 (as amended in 2008):

Only Type A bats shall be used in One Day International matches.

7 LAW 7 - THE PITCH**7.1 Law 7.3 - Selection and preparation**

The following will apply in addition to Law 7.3:

- 7.1.1 The ground staff shall ensure that during the period prior to the start of play and during intervals, the pitch area shall be roped off so as to prevent unauthorised access. (The pitch area shall include an area at least 2 metres beyond the rectangle made by the crease markings at both ends of the pitch).
- 7.1.2 The third umpire shall ensure that, prior to the start of play and during any intervals, only authorised staff, the ICC match officials, players, team coaches and authorised television personnel shall be allowed access to the pitch area. Such access shall be subject to the following limitations:
 - a) Only captains and team coaches may walk on the actual playing surface of the pitch area (outside of the crease markings).
 - b) Access to the pitch area by television personnel shall be restricted to one camera crew (including one or two television commentators) of the official licensed television broadcasters(s) (but not news crews).
 - c) No spiked footwear shall be permitted.
 - d) No one shall be permitted to bounce a ball on the pitch, strike it with a bat or cause damage to the pitch in any other way.
 - e) Access shall not interfere with pitch preparation.
- 7.1.3 In the event of any dispute, the ICC Match Referee (if one is present and on duty at the ground) or the umpires will rule and their ruling will be final.

7.2 Law 7.4 - Changing the pitch

The following shall apply, except that the reference to ICC Match Referee will only apply if one is present and on duty at the ground.

Law 7.4 shall be replaced by the following:

- 7.2.1 In the event of a pitch being considered too dangerous for play to continue in the estimation of the on-field umpires, they shall stop play and immediately advise the ICC Match Referee.
- 7.2.2 The on-field umpires and ICC Match Referee shall consult with both captains.
- 7.2.3 If the captains agree to continue, play shall resume.
- 7.2.4 If the decision is not to resume play, the on-field umpires together with the ICC Match Referee or umpires shall consider whether the existing pitch can be repaired and the match resumed from the point it was stopped. In considering whether to authorise such repairs, the ICC Match Referee or umpires must consider whether this would place either side at an unfair advantage, given the play that had already taken place on the dangerous pitch.

- 7.2.5 If the decision is that the existing pitch cannot be repaired, then the match is to be abandoned with the following consequences:
- a) In the event of the required number of overs to constitute a match having been completed at the time the match is abandoned, the result shall be determined according to the provisions of clause 21.7.2.
 - b) In the event of the required number of overs to constitute a match not having been completed, the match will be abandoned as a no result.
- 7.2.6 If the match is abandoned as a no result, the ICC Match Referee or umpires shall consult with the Home Board with the objective of finding a way for a new match to be commenced and completed on the same date (including any reserve day) and venue.
- 7.2.7 Such a match may be played either on the repaired pitch or on another pitch, subject to the ICC Match Referee or umpires and the relevant ground authority both being satisfied that the new pitch will be of the required ODI standard. The playing time lost between the scheduled start time of the original match and the actual start time of the new match will be covered by the provisions of clauses 12 and 16 below.
- 7.2.8 If it is not possible to play a new match on the scheduled day of the match (including any reserve day), the relevant officials from the participating Boards shall agree on whether the match can be replayed within the existing tour schedule.
- 7.2.9 Throughout the above decision making processes, the ICC Match Referee or umpires shall keep informed both captains and the head of the ground authority. The head of the ground authority shall ensure that suitable and prompt public announcements are made.

7.3 Law 7.5 - Non-turf pitches

Law 7.5 shall not apply.

All matches shall be played on natural turf pitches. The use of PVA and other adhesives in the preparation of pitches is not permitted.

8 LAW 8 - THE WICKETS

8.1 Law 8.2 - Size of stumps

The following shall apply in addition to Law 8.2:

For televised matches the Home Board may provide a slightly larger cylindrical stump to accommodate the stump camera. When the larger stump is used, all three stumps must be exactly the same size.

8.2 Zing Wickets

For televised matches, the use of Zing wickets is permitted.

Refer also to Appendix 7 clause 2.5.

9 LAW 9 - THE BOWLING, POPPING AND RETURN CREASES

9.1 Law 9.3 - The popping crease

Law 9.3 shall apply, except that the reference to 'a minimum of 6 ft' shall be replaced by 'a minimum of 15 yards (13.71 metres)'.

9.2 Additional Crease Markings

The following shall apply in addition to Law 9:

As a guideline the umpires for the calling of wides on the offside the crease markings detailed in Appendix 4 shall be marked in white at each end of the pitch.

10 LAW 10 - PREPARATION AND MAINTENANCE OF THE PLAYING AREA**10.1 Law 10.1 - Rolling**

The following shall apply in addition to Law 10.1:

- 10.1.1 Prior to tossing for choice of innings the artificial drying of the pitch and outfield shall be at the discretion of the ground curator.

Thereafter and throughout the match the drying of the outfield may be undertaken at any time by the ground curator, but the drying of the affected area of the pitch shall be carried out only on the instructions and under the supervision of the umpires.

The umpires shall be empowered to have the pitch dried without reference to the captains at any time they are of the opinion that it is unfit for play.

- 10.1.2 The umpires may instruct the ground curator, to use any available equipment, including any roller for the purpose of drying the pitch and making it fit for play.
- 10.1.3 An absorbent roller may be used to remove water from the covers including the cover on the match pitch.

10.2 Law 10.6 - Maintenance of footholes

The following shall apply in addition to Law 10.6:

The umpires shall see that wherever possible and whenever it is considered necessary, action is taken during all intervals in play to do whatever is practicable to improve the bowler's foot holes.

10.3 Protection and preparation of adjacent pitches during matches

The protection (by way of an appropriate cover) and preparation of pitches which are adjacent to the match pitch will be permitted during the match subject to the following:

- 10.3.1 Such measures will only be possible if requested by the ground curator and approved by the umpires before the start of the match.
- 10.3.2 Approval should only be granted where such measures are unavoidable and will not compromise the safety of the players or their ability to execute their actions with complete freedom.
- 10.3.3 The preparation work shall be carried out under the supervision of the fourth umpire.
- 10.3.4 Any necessary watering shall be carried out only to the extent necessary for such preparations and shall not be permitted in circumstances which may in any way affect the match pitch.
- 10.3.5 The consent of the captains is not required but the umpires shall advise both captains and the ICC Match Referee (if one is present and on duty at the ground) before the start of the match on what has been agreed.

11 LAW 11 - COVERING THE PITCH

11.1 Law 11.1 - Before the match

The following shall apply in addition to Law 11.1:

The pitch shall be entirely protected against rain up to the commencement of play.

11.2 Law 11.2 - During the match

Law 11.2 shall be replaced by the following:

The pitch shall be entirely protected against rain up to the commencement of play and for the duration of the period of the match.

The covers must totally protect the pitch and also the pitch surroundings, a minimum 5 metres either sides of the pitch and any worn or soft areas in the outfield.

11.3 Law 11.3 - Covering bowlers' run ups

Law 11.3 shall be replaced by the following:

The bowler's run-ups shall be covered in inclement weather, in order to keep them dry, to a distance of at least 10 x 10 metres.

11.4 Law 11.4 - Removal of covers

Law 11.4 shall be replaced by the following:

All covers (including "hessian" or "scrim" covers used to protect the pitch against the sun) shall be removed not later than 2½ hours before the scheduled start of play provided it is not raining at the time, but the pitch will be covered again if rain falls prior to the commencement of play.

Attention is drawn to clauses 3.5 and 10.3 above.

12 LAW 12 - INNINGS

Law 12 shall apply subject to the following (see also Clauses 15 and 16 below):

12.1 Law 12.1 shall be replaced by the following:

All matches will consist of one innings per side, each innings being limited to a maximum of 50 overs. All matches shall be of one day's scheduled duration provided that participating countries in a series may agree to provide for a reserve day on which an incomplete match may be replayed or continued from the scheduled day.

If the match is to be continued on the reserve day, the participating countries may agree either that:

12.1.1 Any revision of overs occurs on the final scheduled day of the match; or

12.1.2 Every effort is made to complete the match on the scheduled day with necessary reduction in overs taking place and only if the minimum number of overs necessary to constitute a match cannot be bowled on the scheduled day will the match be completed on the reserve day.

12.1.3 If the match has started on the scheduled day and overs are subsequently reduced following an interruption, but no further play is possible, the match will resume on the reserve day at the point where the last ball was played. Refer Appendix 8.

12.2 Law 12.2 – Alternate innings

Law 12.2 shall not apply

12.3 Law 12.3 – Completed innings

Laws 12.3 (c), (d), (e), (iii) shall not apply

12.4 Length of Innings**12.4.1 Uninterrupted Matches**

- a) Each team shall bat for 50 overs unless all out earlier.
- b) If the team fielding first fails to bowl the required number of overs by the scheduled time for cessation of the first innings, play shall continue until the required number of overs has been bowled. The interval shall be reduced to enable the second innings to commence at the scheduled time, subject to there being a minimum interval of 30 minutes. The team batting second shall receive its full quota of 50 overs irrespective of the number of overs it bowled in the scheduled time for the cessation of the first innings.
- c) If the team batting first is dismissed in less than 50 overs, the team batting second shall be entitled to bat for 50 overs.
- d) If the team fielding second fails to bowl for 50 overs by the scheduled cessation of time, the hours of play shall be extended until the required number of overs have been bowled or a result is achieved.
- e) Penalties shall apply for slow over rates (refer ICC Code of Conduct)

12.4.2 Delayed or Interrupted Matches

- a) Delay of interruption to the Innings of the Team Batting First (see Appendix 2)
 - i) When playing time has been lost the revised number of overs to be bowled in the match shall be based on a rate of 15.79 overs per hour, which is inclusive of the provision of drinks intervals, in the total time available for play.
 - ii) The revision of the number of overs should ensure, whenever possible, that both teams have the opportunity of batting for the same number of overs. The team batting second shall not bat for a greater number of overs than the first team unless the latter completed its innings in less than its allocated overs. To constitute a match, a minimum of 20 overs have to be bowled to the side batting second, subject to a result not being achieved earlier.
 - iii) As soon as the total minutes of playing time remaining is less than the completed overs faced by Team 1 multiplied by 3.8, then the first innings is terminated and the provisions of 12.4.2 b) below take effect

- iv) A fixed time will be specified for the commencement of the interval, and also the close of play for the match, by applying a rate of 15.79 overs per hour. When calculating the length of playing time available for the match, or the length of either innings, the timing and duration of all relative delays, extensions in playing hours, interruptions in play, and intervals, excluding those for drinks, will be taken into consideration. This calculation must not cause the match to finish earlier than the original or rescheduled time for cessation of play on the final scheduled day of play. If required the original time shall be extended to allow for one extra over for each team.
- v) If the team fielding first fails to bowl the revised number of overs by the specified time, play shall continue until the required number of overs have been bowled or the innings is completed.
- vi) Penalties shall apply for the slow over rates (refer to ICC Code of Conduct)
- b) Delay of interruption to the Innings of the Team Batting Second (see Appendix 3)
 - i) When playing time has been lost and, as a result, it is not possible for the team batting second to have the opportunity of receiving its allocated, or revised allocation of overs in the playing time available, the number of overs shall be reduced at a rate of 15.79 overs per hour, which is inclusive of the provision of drinks intervals, in respect of the lost playing time. Should the calculations result in a fraction of an over the fraction shall be ignored.
 - ii) In addition, should the innings of the team batting first have been completed prior to the scheduled, or re-scheduled time for the commencement of the interval, then any calculation relating to the revision of overs shall not be effective until an amount of time equivalent to that by which the second innings started early has elapsed.
 - iii) To constitute a match, a minimum of 20 overs have to be bowled to the team batting second subject to a result not being achieved earlier.
 - iv) The team batting second shall not bat for a greater number of overs than the first team unless the latter completed its innings in less than its allocated overs.
 - v) A fixed time will be specified for the close of play by applying a rate of 15.79 overs per hour. With the exception of drinks intervals, the timing and duration of all relative delays, extensions in playing hours and interruptions in play, will be taken into consideration in specifying this time.
 - vi) If the team fielding second fails to bowl the revised overs by the scheduled or re-scheduled close of play, the hours of play shall be extended until the overs have been bowled or a result achieved.
 - vii) Penalties shall apply for slow over rates (refer to ICC Code of Conduct).

12.5 Extra Time

The participating countries may agree to provide for extra time where the start of play is delayed or play is suspended.

12.6 Number of Overs per Bowler

No bowler shall bowl more than 10 overs in an innings.

In a delayed or interrupted match where the overs are reduced for both teams or for the team bowling second, no bowler may bowl more than one-fifth of the total overs allowed.

Where the total overs is not divisible by 5, one additional over shall be allowed to the maximum number per bowler necessary to make up the balance.

In the event of a bowler breaking down and being unable to complete an over, the remaining balls will be allowed by another bowler. Such part of an over will count as a full over only in so far as each bowler's limit is concerned.

The scoreboard shall show the total number of overs bowled and the number of overs bowled by each bowler.

12.7 Law 12.4 - The toss

Law 12.4 shall be replaced by the following:

The captains shall toss for the choice of innings, on the field of play and in the presence of the ICC Match Referee (if one is present and on duty at the ground) or an umpire, who shall supervise the toss. The toss shall take place not earlier than 30 minutes, nor later than 15 minutes before the scheduled or any rescheduled time for the match to start. Note, however, the provisions of Law 1.3 (Captain).

Note: Law 12.5 requiring the captain of the side winning the toss to notify the opposing captain as soon as the toss is completed of his decision to bat or to field shall apply.

13 LAW 13 - THE FOLLOW-ON

Law 13 shall not apply.

14 LAW 14 - DECLARATION AND FORFEITURE

Law 14 shall not apply.

15 LAW 15 - INTERVALS

Law 15 shall apply subject to the following:

15.1 Law 15.5 - Changing agreed times for intervals - Interval between Innings

If the innings of the team batting first is completed prior to the scheduled time for the interval, the interval shall take place immediately and the innings of the team batting second will commence correspondingly earlier providing that this does not lead to an interval occurring more than 30 minutes prior to the scheduled interval.

If the innings of the team batting first is completed more than 30 minutes prior to the scheduled interval a 10 minute break will occur and the team batting second will commence its innings and the interval will occur as scheduled.

Where the innings of the side batting first is delayed or interrupted, the length of the interval will be reduced as follows:

- i) If up to 15 minutes of actual playing time is lost (total playing time lost less any extra time provided), then the interval will be reduced by the amount of actual playing time lost.
- ii) If more than 15 minutes of actual playing time is lost (total playing time lost less any extra time provided), then the interval will be reduced to 30 minutes (subject to (iii) below).
- iii) Note: The prescribed interval timings above may be reduced further by the ICC Match Referee (if one is present and on duty at the ground) or the umpires taking into account the intention of not having a prolonged interval after a lengthy interruption close to the conclusion of the innings of the team batting first. However, the minimum interval shall not be less than ten minutes.

16 LAW 16 - START OF PLAY; CESSATION OF PLAY

Law 16 shall apply subject to the following (see also clauses 15 and 12.4):

16.1 Law 16.1 – Start and Cessation Times

To be determined by the Home Board subject to there being 2 sessions of 3 hours 10 minutes each, separated by a 45 minute interval between innings.

Note: The playing hours of matches scheduled to take place at venues where dew is likely to be a factor should be determined so as to ensure that the effect of any dew is minimised.

16.2 Laws 16.6, 16.7 and 16.8 shall not apply.

16.3 Laws 16.9, 16.10, and 16.11 shall apply in so far as they are relevant to a one innings limited overs type match.

16.4 Minimum Over Rates

The minimum over rate to be achieved in ODI matches will be 15.79 overs per hour.

The actual over rate will be calculated at the end of the match by the umpires.

In calculating the actual over rate for the match, allowances will be given for the actual time lost as a result of any of the following:

- 16.4.1 treatment given to a player by an authorised medical personnel on the field of play;
- 16.4.2 a player being required to leave the field as a result of a serious injury;
- 16.4.3 all third umpire referrals and consultations;
- 16.4.4 time wasting by the batting side; and
- 16.4.5 all other circumstances that are beyond the control of the fielding side.

In the event of any time allowances being granted to the fielding team under 16.4.4 above (time wasting by batting team), then such time shall be deducted from the allowances granted to such batting team in the determination of its over rate.

If a side is bowled out within the time determined for that innings pursuant to these playing conditions (taking into account all of the time allowances set out above), the fielding side shall be deemed to have complied with the required minimum over rate.

17 LAW 17 - PRACTICE ON THE FIELD

Law 17.1 shall apply subject to the following:

17.1 Law 17.1 – Practice on the pitch or the rest of the square

- a) The use of the square for practice on any day of any match will be restricted to any netted practice area or bowling strips specifically prepared on the edge of the square for that purpose.
- b) Bowling practice on the bowling strips referred to in (a) above shall also be permitted during the interval (and change of innings if not the interval) unless the umpires consider that, in the prevailing conditions of ground and weather, it will be detrimental to the surface of the square.

17.2 Law 17.3 - Practice on the outfield between the call of play and the call of time

Law 17.3 shall apply save that Law 17.3 (c) shall be replaced with the following:

- c) There shall be no bowling or batting practice on the outfield. Bowling a ball, using a short run up to a player in the outfield is not to be regarded as bowling practice but shall be subject to the law.

18 LAW 18 - SCORING RUNS

Law 18 shall apply.

19 LAW 19 - BOUNDARIES

Law 19 shall apply subject to the following:

19.1 Law 19.1 - The boundaries of the field of play

The following shall apply in addition to Law 19.1:

The boundary shall be a minimum of 55 yards (50.29 metres) and a maximum of 65 yards (59.44 metres). Distances shall be measured from the centre of the pitch.

Any ground on which a Test or ODI International has been played prior to 1st July 1995 which cannot conform with these minimum dimensions shall be exempt from this playing condition. Any new ground must conform to these minimum dimensions.

19.2 Law 19.2 - Defining the boundary - boundary marking

The following shall apply in addition to Law 19.2:

All boundaries must be designated by a rope or similar object of a minimum standard as authorised by the ICC from time to time. Where appropriate the rope should be a required minimum distance (3 yards (2.74 metres) minimum) inside the perimeter fencing or advertising signs.

19.3 Law 19.3 - Scoring a boundary

The following shall apply in addition to Law 19.3:

If an unauthorized person enters the playing arena and handles the ball, the umpire at the bowler's end shall be the sole judge of whether the boundary allowance should be scored or the ball be treated as still in play or called dead ball if a batter is liable to be out as a result of the unauthorized person handling the ball. See also Law 19.1 (c).

20 LAW 20 - LOST BALL

Law 20 shall apply.

21 LAW 21 - THE RESULT

Law 21 shall apply subject to the following:

21.1 Law 21.1 - A win - two innings match

Law 21.1 shall not apply.

21.2 Law 21.2 - A win - one innings match

Law 21.2 shall apply in addition to the following:

21.2.1 Save for circumstances where a match is awarded to a team as a consequence of the opposing teams refusal to play (Law 21.3), a result can be achieved only if both teams have had the opportunity of batting for at least 20 overs, unless one team has been all out in less than 20 overs or unless the team batting second scores enough runs to win in less than 20 overs.

21.2.2 Save for circumstances where a match is awarded to a team as a consequence of the opposing teams refusal to play (Law 21.3), all matches in which both teams have not had an opportunity of batting for a minimum of 20 overs, shall be declared no result.

21.3 Law 21.3 – Umpire (ICC Match Referee) awarding a match

Law 21.3 shall be replaced by the following:

- a) A match shall be lost by a side which either
 - i) concedes defeat or
 - ii) in the opinion of the ICC Match Referee refuses to play and the ICC Match Referee shall award the match to the other side.
- b) If an umpire considers that an action by any player or players might constitute a refusal by either side to play then the umpires together shall inform the ICC Match Referee of this fact. The ICC Match Referee shall together with the umpires ascertain the cause of the action. If the ICC Match Referee, after due consultation with the umpires, then decides that this action does constitute a refusal to play by one side, he shall so inform the captain of that side. If the captain persists in the action the Referee shall award the match in accordance with (a)(ii) above.*
- c) If action as in (b) above takes place after play has started and does not constitute a refusal to play the delay or interruption in play shall be dealt with in the same manner as provided for in clauses 12.4.2 and 15.1 above.

* N/B In addition to the consequences of any refusal to play prescribed under this clause, any such refusal, whether temporary or final, may result in disciplinary action being taken against the captain and team responsible under the Code of Conduct.

21.4 Law 21.4 – Matches in which there is an agreement under Law 12.1 (b)

Law 21.4 shall not apply.

21.5 Law 21.5 (a) - A Tie

Law 21.5 shall apply in addition to the following:

- 21.5.1 If the scores are equal, the result shall be a tie and no account shall be taken of the number of wickets which have fallen.

21.6 Law 21.5 (b) - A Draw

Law 21.5 (b) shall not apply.

21.7 Prematurely Terminated Matches - Calculation of the Target Score**21.7.1 Interrupted Matches - Calculation of the Target Score**

If, due to suspension of play after the start of the match, the number of overs in the innings of either team has to be revised to a lesser number than originally allotted (minimum of 20 overs), then a revised target score (to win) should be set for the number of overs which the team batting second will have the opportunity of facing. This revised target is to be calculated using the current Duckworth/Lewis method. The target set will always be a whole number and one run less will constitute a Tie. (Refer Duckworth/Lewis Regulations).

21.7.2 Prematurely Terminated Matches

If the innings of the side batting second is suspended (with at least 20 overs bowled) and it is not possible for the match to be resumed, the match will be decided by comparison with the D/L 'Par Score' determined at the instant of the suspension by the Duckworth/Lewis method (refer Duckworth/Lewis Regulations). If the score is equal to the par score, the match is a Tie.

Otherwise the result is a victory, or defeat, by the margin of runs by which the score exceeds, or falls short of, the Par Score.

21.8 Correctness of result

Any query on the result of the match as defined in Laws 21.2, 21.3, 21.5, 21.8 and 21.10 (as modified by these regulations) shall be resolved as soon as possible and a final decision made by the umpires at close of play.

21.9 Points**21.9.1 Preliminary matches**

In a competition with three or more teams and with a final match or series, the Home Board will institute a points system as follows:

Win, with bonus point	5
Win, without bonus point	4
Tie or No Result	2
Loss	0

In the event of teams finishing on equal points, the right to play in the final match or series will be determined as follows:

- The team with the most number of wins.
- If still equal, the team with the most number of wins over the other team(s) who are equal on points and have the same number of wins.
- If still equal, the team with the highest number of bonus points.
- If still equal, the team with the highest net run rate.

In a match declared as no result, run rate is not applicable.

21.9.2 Net Run Rate

A team's net run rate is calculated by deducting from the average runs per over scored by that team throughout the competition, the average runs per over scored against that team throughout the competition.

In the event of a team being all out in less than its full quota of overs, the calculation of its net run rate shall be based on the full quota of overs to which it would have been entitled and not on the number of overs in which the team was dismissed.

Only those matches where results are achieved will count for the purpose of net run rate calculations. Where a match is abandoned, but a result is achieved under Duckworth/Lewis, for net run rate purposes Team 1 will be accredited with Team 2's Par Score on abandonment off the same number of overs faced by Team 2.

Where a match is concluded but with Duckworth/Lewis having been applied at an earlier point in the match, Team 1 will be accredited with 1 run less than the final Target Score for Team 2 off the total number of overs allocated to Team 2 to reach the target.

21.9.3 Bonus Points

The team that achieves a run rate of 1.25 times that of the opposition shall be awarded one bonus point. A team's run rate will be calculated by reference to the runs scored in an innings divided by the number of overs faced. Refer Appendix 6.

21.9.4 Final Match or Series

If no result is achieved in a final the match shall be declared drawn.

In the event of a drawn final, the prize money (if applicable), will be shared equally between the two competing teams.

22 LAW 22 - THE OVER

Law 22 shall apply subject to the addition of the following to Law 22.5:

22.1 Law 22.5 - Umpire miscounting

Whenever possible the third umpire shall liaise with the scorers and if possible inform the on-field umpires if the over has been miscounted.

23 LAW 23 - DEAD BALL

Law 23 shall apply subject to the addition of the following to Law 23.4.

23.1 Law 23.4 - Umpire calling and signalling 'Dead Ball'

In a match where cameras are being used on or over the field of play (e.g. Spydercam), should a ball that has been hit by the batter make contact, while still in play, with the camera, its apparatus or its cable, either umpire shall call and signal 'dead ball'. The ball shall not count as one of the over and no runs shall be scored. If the delivery was called a no ball it shall count and the no ball penalty applied, including if appropriate a free hit from the next delivery. No other runs (including penalty runs) apart from the no ball penalty shall be scored.

Should a ball thrown by a fielder make contact with a camera on or over the field of play, its apparatus or its cable, either umpire shall call and signal dead ball. Unless this was already a no-ball or wide, the ball shall count as one of the over. All runs scored to that point shall count, plus the run in progress if the batters have already crossed.

24 LAW 24 - NO BALL

Law 24 shall apply subject to the following:

24.1 Law 24.1 (b) Mode of delivery

Law 24.1 (b) shall be replaced by the following:

The bowler may not deliver the ball underarm. If a bowler bowls a ball underarm the umpire shall call and signal no ball, and the ball is to be re-bowled overarm.

24.2 Free hit after a foot-fault no ball

In addition to the above the delivery following a no ball called for a foot fault (Law 24.5) shall be a free hit for whichever batter is facing it. If the delivery for the free hit is not a legitimate delivery (any kind of no ball or a wide ball) then the next delivery will become a free hit for whichever batter is facing it.

For any free hit, the striker can be dismissed only under the circumstances that apply for a no ball, even if the delivery for the free hit is called wide ball.

Field changes are not permitted for free hit deliveries unless there is a change of striker (the provisions of clause 41.2 shall apply).

The umpires will signal a free hit by (after the normal No Ball signal) extending one arm straight upwards and moving it in a circular motion.

24.3 Fair Delivery - the feet

Law 24.5 shall apply, subject to the final paragraph being replaced by the following:

If the bowler's end umpire is satisfied that any of these three conditions have not been met, he shall call and signal No ball

25 LAW 25 - WIDE BALL**25.1 Law 25.1 - Judging a Wide**

Law 25 shall apply with the following addition to Law 25.1:

Umpires are instructed to apply very strict and consistent interpretation in regard to this Law in order to prevent negative bowling wide of the wicket.

Any offside or legside delivery which in the opinion of the umpire does not give the batter a reasonable opportunity to score shall be called a wide.

A penalty of one run for a wide shall be scored. This penalty shall stand in addition to any other runs which are scored or awarded. All runs, which are run or result from a wide ball, which is not a no ball, shall be scored wide balls.

26 LAW 26 - BYE AND LEG BYE

Law 26 shall apply.

27 LAW 27 - APPEALS

Law 27 shall apply.

28 LAW 28 - THE WICKET IS DOWN

Law 28 shall apply.

29 LAW 29 - BATTER OUT OF HER GROUND

Law 29 shall apply.

30 LAW 30 - BOWLED

Law 30 shall apply.

31 LAW 31 - TIMED OUT

Law 31 shall apply.

Refer also to clause 42.9 (Law 42.10)

32 LAW 32 - CAUGHT

Law 32 shall apply.

33 LAW 33 - HANDLED THE BALL

Law 33 shall apply.

34 LAW 34 - HIT THE BALL TWICE

Law 34 shall apply.

35 LAW 35 - HIT WICKET

Law 35 shall apply.

36 LAW 36 - LEG BEFORE WICKET

Law 36 shall apply.

37 LAW 37 - OBSTRUCTING THE FIELD

Law 37 shall apply. For the avoidance of doubt, if an umpire feels that a batter, in running between the wickets, has significantly changed his direction without probable cause and thereby obstructed a fielder's attempt to effect a run out, the batter should, on appeal, be given out, obstructing the field. It shall not be relevant whether a run out would have occurred or not.

If the change of direction involves the batter crossing the pitch, Law 42.14 shall also apply.

38 LAW 38 - RUN OUT

Law 38 shall apply.

39 LAW 39 - STUMPED

Law 39 shall apply.

40 LAW 40 - THE WICKET-KEEPER

Law 40 shall apply.

41 LAW 41 - FIELDER

Law 41 shall apply subject to the following:

41.1 Law 41.1 - Protective equipment

The following shall apply in addition to Law 41.1:

The exchanging of protective equipment between members of the fielding side on the field shall be permitted provided that the umpires do not consider that it constitutes a waste of playing time.

41.2 Restrictions on the placement of fielders

41.2.1 At the instant of delivery, there may not be more than 5 fielders on the leg side.

41.2.2 In addition to the restriction contained in clause 41.2.1 above, further fielding restrictions shall apply to certain overs in each innings. The nature of such fielding restrictions and the overs during which they shall apply (hereinafter referred to as the Powerplay Overs) are set out in the following paragraphs.

41.2.3 The following fielding restrictions shall apply:

- a) Two semi-circles shall be drawn on the field of play. The semi-circles shall have as their centre the middle stump at either end of the pitch. The radius of each of the semi-circles shall be 25.15 yards (23 metres). The semi-circles shall be linked by two parallel straight lines drawn on the field. (Refer attached appendix 5). The fielding restriction areas should be marked by continuous painted white lines or 'dots' at 5 yard (4.57 metres) intervals, each 'dot' to be covered by a white plastic or rubber (but not metal) disc measuring 7 inches (18 cm) in diameter.

During the first block of Powerplay Overs (as set out below), only two fieldsmen shall be permitted outside this fielding restriction area at the instant of delivery.

During the second block of Powerplay Overs only three fieldsmen shall be permitted outside the fielding restriction area at the instant of delivery.

- b) Two inner circles shall be drawn on the field of play. The circles shall have as their centres the centrepoint of the popping crease at either end of the pitch. The radius of each of the circles shall be 13.12 yards (12 metres) (The fielding restriction area should be marked by 'dots'. The segment of the circles reserved for the slip positions shall not be demarcated (refer attached Appendix 5).

During the first block of Powerplay Overs (in an uninterrupted innings, the first 10), there must be a minimum of two stationary fielders within this fielding restriction area at the instant of delivery. When a fast bowler is bowling the two stationary fielders may be permitted to stand deeper than 13.12 yards (12 metres) (in the undemarcated area) provided only that they are standing in slip, leg slip or gully positions.

- 41.2.4 During the non Powerplay Overs, no more than four fielders shall be permitted outside the fielding restriction area referred to in clause 41.2.3 a) above.
- 41.2.5 Subject to the provisions of 41.2.6 below, the Powerplay Overs shall apply for 15 overs per innings to be taken as follows:
- The first block of Powerplay Overs (block of 10 overs for an uninterrupted match) shall be at the commencement of the innings.
 - The second block of Powerplay Overs (block of 5 overs for an uninterrupted match) shall be taken at the discretion of either of the batsmen at the wicket. In an innings of scheduled duration of between 41 and 50 overs, it may not be completed later than the 40th over. (No equivalent restriction applies to innings of shorter scheduled duration.)
 - A batter must nominate her team's Powerplay no later than the moment at which the umpire reaches the stumps at the bowler's end for the start of the next over. The fielding captain may nominate her team's Powerplay any time prior to the commencement of the over. The umpire who will stand at the bowler's end for the commencement of a Powerplay block shall determine which side first made the request.
 - Once a batter has nominated a Powerplay, the decision can not be reversed.
 - Should the batting side choose not to exercise their discretion, their Powerplay Overs will automatically commence at the latest available point in the innings (e.g. in a 50 over innings with one unclaimed Powerplay, this will begin at the start of the 36th over).
- 41.2.6 In circumstances when the number of overs of the batting team is reduced, the number of Powerplay Overs shall be reduced in accordance with the table below. For the sake of clarity, it should be noted that the table shall apply to both the 1st and 2nd innings of the match.

INNINGS DURATION	FIRST POWERPLAY	SECOND POWERPLAY	POWERPLAY TOTAL
20 - 21	4	2	6
22 - 24	5	2	7
25 - 28	5	3	8
29 - 31	6	3	9
32 - 34	7	3	10
35 - 38	7	4	11
39 - 41	8	4	12
42 - 44	9	4	13
45 - 48	9	5	14
49	10	5	15

- 41.2.7 Each block of Powerplay Overs must commence at the start of an over.

- 41.2.8 If play is interrupted not during the Powerplay overs, then on resumption, it is necessary to determine how any remaining Powerplay overs should be allocated. The total number of Powerplay overs for the innings is derived from the table in 41.2.6. Any Powerplay overs already taken prior to the interruption will be deemed to have been from the initial allocation followed by the batting side's allocation. The decision of the batting side of when to take any remaining Powerplay overs is made in the usual way.

Illustrations of 41.2.8:

A match starts as 50 overs, is interrupted after 12 overs and reduced to 43 overs. (The first 10 overs have been Powerplays (PP); the next two were not.) The new PP allocation is 9+4, so there are 3 overs left for the batting side. These must start no later than the 38th over in order to be completed by the 40th over.

- 41.2.9 If play is interrupted during the first Powerplay and on resumption the overs required to be bowled in that Powerplay have already been exceeded, then the second Powerplay will be assumed to have been taken immediately and will continue until it is completed.

Illustrations of 41.2.9

A 50 over innings is interrupted after 9.3 overs, and on resumption has been reduced to 43 overs. Powerplay overs are 9+4. 2nd Powerplay is in progress with 0.3 out of the 4 overs completed, i.e. it covers overs 10 to 13. The fielding restrictions relating to the second powerplay take immediate effect on resumption.

- 41.2.10 If following an interruption, on resumption the total number of Powerplay Overs for the innings has already been exceeded, then there will be no further Powerplay deliveries bowled in the innings. Note that this is the only circumstance under which the Powerplay status can be changed during an over.

Illustrations of 41.2.10

A 45 over innings is interrupted after 8.3 overs, and on resumption has been reduced to 28 overs. Powerplay overs are 5+3. All Powerplay overs have been completed. Non-Powerplay restrictions take effect immediately and do not need to wait until the end of the over.

- 41.2.11 If following an interruption while a Powerplay is not in progress, it is found on resumption that the recalculated number of Powerplay Overs remaining exceeds the number of overs to be bowled in the innings, then the Powerplays will commence at the start of the next over, with fewer than the scheduled number of Powerplay Overs being bowled in the innings.

Illustration of 41.2.11:

A 41 over innings in which only the 1st Powerplay has been taken is interrupted after 35.1 overs and reduced to 39 overs. Powerplay overs are still 8+4. Powerplays automatically resume for the start of the next over, but only 11 of the 12 scheduled Powerplay overs can be bowled in the innings.

- 41.2.12 If following an interruption while a Powerplay is not in progress, it is found on resumption that the recalculated number of Powerplay overs remaining exceeds the number of overs to be bowled in the innings, then the Powerplays will commence at the start of the next over, with fewer than the scheduled number of Powerplay overs being bowled in the innings.

Illustration of 41.2.12:

A 50 over innings in which only the 1st Powerplay has been taken is interrupted after 29.1 overs and reduced to 32 overs. Powerplay overs are 7+3+3. Powerplays automatically resume for the start of the next over, but only 12 of the 13 scheduled Powerplay overs can be bowled in the innings.

- 41.2.13 At the commencement of the second block of Powerplay Overs, the umpire shall signal such commencement to the scorers by rotating his arm in a large circle.
- 41.2.14 The umpire shall also indicate to the fielding captain before any signal is made that the batting side has chosen its Powerplay.
- 41.2.15 A light or other indicator shall be displayed on the scoreboard whenever the Powerplay Overs are being bowled, along with the number of overs remaining in the current block of Powerplay Overs.
- 41.2.16 The public address system shall be used to keep the spectators informed.
- 41.2.17 In the event of an infringement of any of the above fielding restrictions, the square leg umpire shall call and signal 'No Ball'.

42 LAW 42 - FAIR AND UNFAIR PLAY

42.1 Law 42.3 - The Match Ball - changing its condition

Law 42.3 shall apply, subject to the following:

Law 42.3 (d) and (e) shall be replaced with the following:

If the umpires together agree that the deterioration of the ball is inconsistent with the use it has received, they shall consider that there has been a contravention of this Law. They shall then decide together whether they can identify the player(s) responsible for such conduct.

- 42.1.1 If it is possible to identify the player(s) responsible:
 - a) Change the ball forthwith. The batter at the wicket shall choose the replacement ball from a selection of six other balls of various degrees of usage (including a new ball) and of the same brand as the ball in use prior to the contravention.
Additionally the bowler's end umpire shall:
 - b) Award 5 penalty runs to the batting side.
 - c) Inform the captain of the fielding side of the reason for the action taken.
 - d) Inform the captain of the batting side as soon as practicable of what has occurred.
 - e) Together with the other umpire report the incident to the ICC Match Referee who shall take action as is appropriate against the player(s) responsible for the conduct under the ICC Code of Conduct.
- 42.1.2 If it is not possible to identify the player(s) responsible:
 - a) Change the ball forthwith. The umpires shall choose the replacement ball for one of similar wear and of the same brand as the ball in use prior to the contravention
 - b) The bowler's end umpire shall issue the captain with a first and final warning, and

- c) Advise her that should there be any further incident by that team during the remainder of the match or series, steps 42.1.1 a) to e) above will be adopted, with the captain deemed under e) to be the player responsible.

42.2 Law 42.4 - Deliberate attempt to distract striker

Law 42.4 shall apply subject to the following:

In addition, the umpires shall report the incident to the ICC Match Referee under the ICC Code of Conduct.

42.3 Law 42.5 - Deliberate distraction or obstruction of batter

Law 42.5 shall apply subject to the following:

In addition, the umpire shall report the incident to the ICC Match Referee under the ICC Code of Conduct.

42.4 Law 42.6 - Dangerous and Unfair Bowling

42.4.1 Law 42.6 (a) - The Bowling of Fast Short Pitched Balls

Law 42.6 (a) shall be replaced by the following:

- a) A bowler shall be limited to two fast short-pitched deliveries per over.
- b) A fast short-pitched delivery is defined as a ball which passes or would have passed above the shoulder height of the striker standing upright at the crease.
- c) The umpire at the bowlers end shall advise the bowler and the batter on strike when each fast short pitched delivery has been bowled.
- d) In addition, for the purpose of this regulation and subject to Clause 42.4.1 (f) below, a ball that passes above head height of the batter, that prevents her from being able to hit it with her bat by means of a normal cricket stroke shall be called a wide.
- e) For the avoidance of doubt any fast short pitched delivery that is called a wide under this playing condition shall also count as one of the allowable short pitched delivery in that over.
- f) In the event of a bowler bowling more than two fast short-pitched deliveries in an over as defined in Clause 42.4.1 (b) above, the umpire at the bowlers end shall call and signal no ball on each occasion. A differential signal shall be used to signify a fast short pitched delivery. The umpire shall call and signal 'no ball' and then tap the head with the other hand.
- g) If a bowler delivers a third fast short pitched ball in an over, the umpire, after the call of no ball and when the ball is dead, shall caution the bowler, inform the other umpire, the captain of the fielding side and the batter at the wicket of what has occurred. This caution shall apply throughout the innings.
- h) If there is a second instance of the bowler being no balled in the innings for bowling more than two fast short pitched deliveries in an over, the umpire shall advise the bowler that this is her final warning for the innings.

- i) Should there be any further instance by the same bowler in that innings, the umpire shall call and signal no ball and when the ball is dead direct the captain to take the bowler off forthwith. If necessary, the over shall be completed by another bowler, who shall neither have bowled the previous over, or part thereof, nor be allowed to bowl the next over, or part thereof.
- j) The bowler thus taken off shall not be allowed to bowl again in that innings.
- k) The umpire will report the occurrence to the other umpire, the batter at the wicket and as soon as possible to the captain of the batting side.
- l) The umpires will then report the matter to the ICC Match Referee who shall take such action as is considered appropriate against the captain and the bowler concerned. (Refer also to Law 42.1 Fair and Unfair Play - Responsibility of the Captains).

The above is not a substitute for Clause 42.5 below which umpires are able to apply at any time.

42.4.2 Law 42.6 (b) Bowling of High Full Pitched Balls

Law 42.6 (b) shall be replaced by the following:

- a) Any delivery, which passes or would have passed on the full above waist height of the striker standing upright at the crease is deemed unfair, whether or not it is likely to inflict physical injury on the striker.
- b) In the event of a bowler bowling a high full pitched ball as defined in Clause 42.4.2 (a) above, the umpire at the bowler's end shall call and signal no ball.

If, in the opinion of the umpire, such a delivery is considered likely to inflict physical injury on the batter, the umpire at the bowler's end shall, in addition to calling and signalling no ball, when the ball is dead, caution the bowler and issue a first and final warning. The umpire shall inform the other umpire, the captain of the fielding side and the batter at the wicket of what has occurred.

- c) Should there be any further instance (where a high full pitched ball is bowled and is considered likely to inflict physical injury on the batter) by the same bowler in that innings, the umpire shall, in addition to calling and signalling no ball, when the ball is dead, direct the captain to take the bowler off forthwith. If necessary, the over shall be completed by another bowler, who shall neither have bowled the previous over, or part thereof, nor be allowed to bowl the next over, or part thereof.
- d) The bowler thus taken off shall not be allowed to bowl again in that innings.
- e) The umpire will report the occurrence to the other umpire, the batter at the wicket and as soon as possible to the captain of the batting side.
- f) The umpires will then report the matter to the ICC Match Referee who shall take such action as is considered appropriate against the captain and the bowler concerned. (Refer also to Law 42.1 Fair and Unfair Play - Responsibility of the Captains.)

42.5 Law 42.7 - Dangerous and Unfair Bowling - Action by the umpire

Law 42.7 shall be replaced by the following:

Regardless of any action taken by the umpire as a result of a breach of Clauses 42.4.1, 42.4.2 and 42.6 the following shall apply at any time during the match:

42.5.1 The bowling of fast short pitched balls is unfair if in the opinion of the umpire at the bowler's end they consider that by their repetition and taking into account their length, height and direction, they are likely to inflict physical injury on the striker, irrespective of the protective clothing and equipment she may be wearing. The relative skill of the striker shall also be taken into consideration.

42.5.2 In the event of such unfair bowling, the umpire at the bowler's end shall adopt the following procedure:

- a) In the first instance the umpire shall call and signal no ball, caution the bowler and inform the other umpire, the captain of the fielding side and the batter of what has occurred.
- b) If this caution is ineffective, they shall repeat the above procedure and indicate to the bowler that this is a final warning.
- c) Both the above caution and final warning shall continue to apply even though the bowler may later change ends.
- d) Should there be any further instance by the same bowler in that innings, the umpire shall call and signal no ball and when the ball is dead direct the captain to take the bowler off forthwith. If necessary, the over shall be completed by another bowler, who shall neither have bowled the previous over, or part thereof, nor be allowed to bowl the next over, or part thereof. See Law 22.8. (Bowler Incapacitated or Suspended during an Over).
- e) The bowler thus taken off shall not be able to bowl again in that innings.
- f) The umpire will report the occurrence to the other umpire, the batter at the wicket and as soon as possible to the captain of the batting side.
- g) The umpires will then report the matter to the ICC Match Referee who shall take such action as is considered appropriate against the captain and the bowler concerned. (Refer also to Law 42.1 Fair and Unfair Play - Responsibility of the Captains).

42.6 Law 42.8 - Deliberate bowling of High Full Pitched Balls

Law 42.8 shall be replaced by the following:

If the umpire considers that a high full pitch delivery which is deemed unfair as defined in Clause 42.4.2 was deliberately bowled, then the caution and warning process shall be dispensed with.

The umpire at the bowler's end shall:

42.6.1 Call and signal no ball.

42.6.2 When the ball is dead, direct the captain to take the bowler off forthwith.

42.6.3 Not allow the bowler to bowl again in that innings.

42.6.4 Ensure that the over is completed by another bowler, provided that the bowler does not bowl two overs or part thereof consecutively.

42.6.5 Report the occurrence to the other umpire, to the captain of the batting side and the ICC Match Referee who shall take such action as is considered appropriate against the captain and the bowler concerned. (Refer also to Law 42.1 Fair and Unfair Play Responsibility of the Captains).

42.7 Action by the umpires for dangerous and unfair Bowling

Should the umpires initiate the caution and warning procedures set out in Clauses 42.4.1, 42.4.2, 42.5 and 42.6 such cautions and warnings are not to be cumulative.

42.8 Law 42.9 - Time Wasting by the Fielding Side

Law 42.9 shall apply subject to Law 42.9 (b) being replaced by the following:

If there is any further waste of time in that innings, by any member of the fielding side the umpire shall:

- a) Call and signal dead ball if necessary, and;
- b) Award 5 penalty runs to the batting side (see Law 42.17).
- c) Inform the other umpire, the batter at the wicket and as soon as possible the captain of the batting side of what has occurred.
- d) Report the occurrence to the ICC Match Referee who shall take such action as is considered appropriate against the captain and the team concerned under the ICC Code of Conduct.

42.9 Law 42.10 - Batter Wasting Time

Law 42.10 shall apply, subject to the following:

If the incoming batter is not in position to take guard or her partner is not ready to receive the next ball within 2 minutes of the fall of the previous wicket, the action should be regarded by the umpires as time wasting and the provisions of Law 42.10 shall apply.

In addition, the umpires will report the incident to the ICC Match Referee under the ICC Code of Conduct.

42.10 Law 42.14 Batter damaging the pitch

Law 42.14 shall apply.

See also clause 37 above.

42.11 Law 42.15 – Bowler attempting to run out non-striker before delivery

Law 42.15 shall be replaced by the following:

The bowler is permitted, before releasing the ball and provided he has not completed his usual delivery swing, to attempt to run out the non-striker. Whether the attempt is successful or not, the ball shall not count as one of the over. If the bowler fails in an attempt to run out the non-striker, the umpire shall call and signal Dead ball as soon possible.

42.11 Use of Electronic Communications Equipment

The use of electronic communication devices and equipment of any kind to communicate with players on the field of play shall not be permitted.

APPENDIX 1

All penalty runs in the Laws of Cricket (2000 Code 5th Edition - 2013) apply in International Cricket.

APPENDIX 2A

Calculation sheet for use when delays or interruptions occur in First Innings

Time

Net playing time available at start of the match	380 minutes	(A)
Time innings in progress	_____	(B)
Playing time lost	_____	(C)
Extra time available	_____	(D)
Time made up from reduced interval	_____	(E)
Effective playing time lost $[C - (D + E)]$	_____	(F)
Remaining playing time available $(A - F)$	_____	(G)
G divided by 3.8 (to 2 decimal places)	_____	(H)
Max overs per team $[H/2]$ (round up fractions)	_____	(I)
Maximum overs per bowler $[I / 5]$	_____	
Duration of Powerplay Overs (initial, batting side)	_____ + _____	

Rescheduled Playing Hours

First session to commence or recommence	_____	(J)
Length of innings $[I \times 3.8]$ (round up fractions)	_____	(K)
Rescheduled first innings cessation time $[(J + K) - B]$	_____	(L)
Length of interval	_____	(M)
Second innings commencement time $(L + M)$	_____	(N)
Rescheduled second innings cessation time $(N + K)$	_____	(O)

* Ensure that the match is not finishing earlier than the original or rescheduled cessation time by applying clause 12.4.2 a) iv). If so, add at least one over to each team and recalculate (I) to (O) above to prevent this from happening.

APPENDIX 2B

Calculation sheet to check whether an interruption during the First Innings should terminate the innings

Proposed re-start time	_____	(P)
Rescheduled cut-off time allowing for full use of any extra time provision	_____	(Q)
Minutes between P and Q	_____	(R)
Potential overs to be bowled $[R / 3.8]$ (round up fractions)	_____	(S)
Number of complete overs faced to date in first innings	_____	(T)

If S is greater than T then revert to Appendix 2A

If S is less than or equal to T then the first innings is terminated and go to Appendix 3A

APPENDIX 3A

Calculation sheet for the start of the Second Innings

Maximum overs to be bowled:

- (If first innings was terminated, S from Appendix 2B) _____ (A)
 Scheduled length of innings: $[A \times 3.8]$ (round up fractions) _____ (B)
 Start time _____ (C)
 Scheduled cessation time $[C + B]$ _____ (D)

Overs per bowler and Fielding Restrictions

- Maximum overs per bowler $[A / 5]$ _____ overs
 Duration of Powerplay overs (initial, batting side) _____ + _____

APPENDIX 3B

Calculation sheet for use when interruption occurs after the start of the Second Innings

Time

- Time at start of innings _____ (A)
 Time at start of interruption _____ (B)
 Time innings in progress _____ (C)
 Restart time _____ (D)
 Length of interruption $[D - B]$ _____ (E)
 Additional time available: (Any unused provision for 'Extra Time' or for earlier than scheduled start of second innings) _____ (F)
 Total playing time lost $[E - F]$ _____ (G)

Overs

- Maximum overs at start of innings _____ (H)
 Overs lost $[F / 3.8]$ (rounded down) _____ (I)
 Adjusted maximum length of innings $[H - I]$ _____ (J)
 Rescheduled length of innings $[J \times 3.8]$ (rounded up) _____ (K)
 Amended cessation time of innings $[D + (K - C)]$ _____ (L)

Overs per bowler and Fielding Restrictions

- Maximum overs per bowler $[J / 5]$ _____ overs
 Duration of Powerplay overs (initial, batting side) _____ + _____

APPENDIX 4 - CREASE MARKINGS

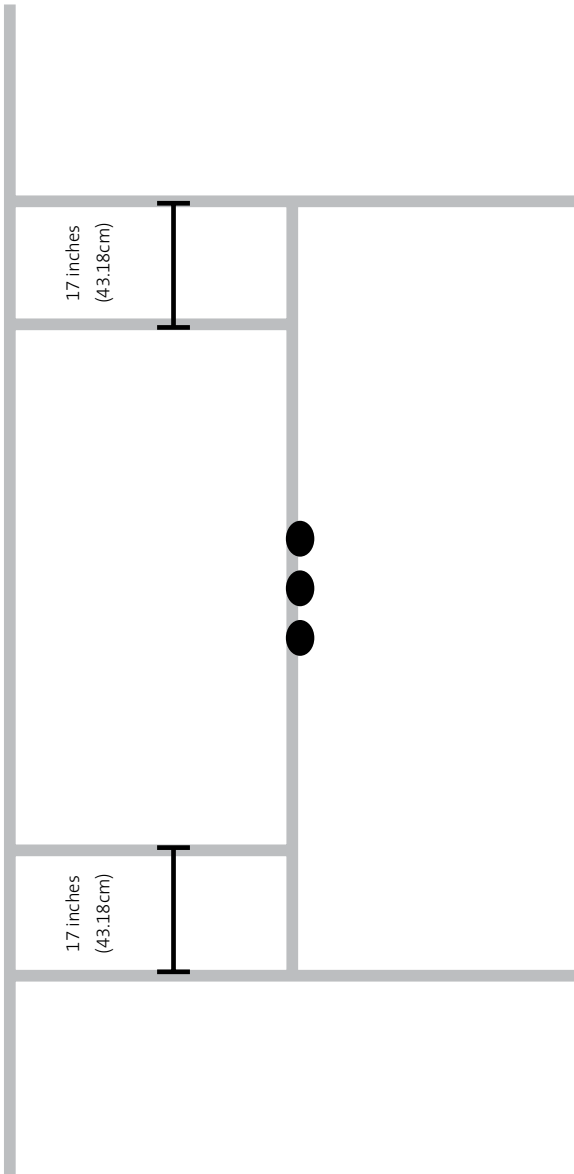

APPENDIX 5

Restriction of the placement of fielders

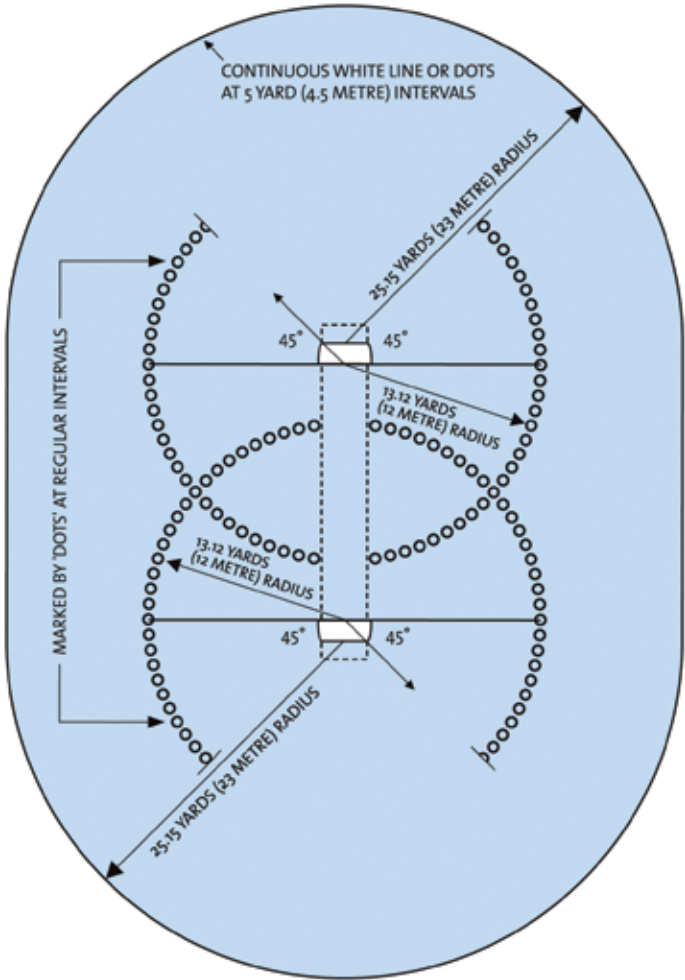

The final mark of the 13.12 yards radius shall be a line placed at an angle of 45°, measured from the popping crease at a point level with the middle stump.

APPENDIX 6

Bonus Point System

1 bonus point for any team that achieves victory with a run rate 1.25 times that of the opposition.

A team's run rate will be calculated by reference to the number of runs scored divided by the number of overs/balls faced.

Where a side is all out, the number of overs to be used is the maximum number of overs that side was otherwise eligible to face.

Where matches are shortened and targets revised through the Duckworth/Lewis system, bonus run rates and bonus defensive targets are derived as a function of the revised target score (less one run) and maximum overs.

Whenever a target, or revised target, is set, the exact number of overs/balls within which the side batting second must achieve this target in order to gain the bonus point should be announced. Once these overs/balls have been bowled, if the target has not then been achieved the bonus point can not be gained by any subsequent event, eg a multiple scoring shot, or extras.

(a) Examples of criteria for the award of bonus points

TEAM BATTING FIRST		TEAM BATTING SECOND		TEAM BOWLING SECOND	
SCORE	RUN RATE	REQUIRED RUN RATE	BALLS TO WIN (OVERS)	REQUIRED RUN RATE	TARGET SCORE
300	6	7.5	40.0	4.8	240
275	5.5	6.875	40.0	4.4	220
250	5	6.25	40.0	4	200
225	4.5	5.625	40.1	3.6	180
200	4	5	40.1	3.2	160
175	3.5	4.375	40.1	2.8	140
150	3	3.75	40.1	2.4	120
125	2.5	3.125	40.1	2	100
100	2	2.5	40.2	1.6	80
75	1.5	1.875	40.3	1.2	60

Note: the 'target score' shown in the last column is the maximum total that the team batting second can make for the team batting first to qualify for the bonus point.

APPENDIX 7**Third Umpire TV Replay System – Playing Conditions****1 GENERAL**

- a) The Home Board shall endeavour to broadcast all ODI Matches played in its country.
- b) Where matches are broadcast the camera specifications set out in Appendix 7A shall be mandatory as a minimum requirement.
- c) Where matches are not broadcast, countries are encouraged to implement the camera specifications as outlined in Appendix 7B.
- d) For televised matches, the Home Board will ensure a separate room is provided for the third umpire and that he has access to a television monitor and direct sound link with the television control unit director to facilitate as many replays as is necessary to assist him in making a decision.
- e) For televised matches, in the circumstances detailed in Clauses 2, 4 and 5 hereunder, the on-field umpire has the discretion whether or not to refer the appeal to the third umpire or, in the case of paragraph 3, 5 and 6 to consult with the third umpire before making his decision and should take a common sense approach. Players may not appeal to the umpire to use the replay system - breach of this provision would constitute dissent and the player could be liable for discipline under the ICC Code of Conduct.
- f) For televised matches, the third umpire shall call for as many replays from any camera angle as is necessary to reach a decision. As a guide, a decision should be made within 30 seconds whenever possible, but the third umpire shall have discretion to take more time in order to finalise a decision.
- g) The third umpire shall only have access to TV replays for the provisions of paragraphs 2, 3, 4, 5 and 6 below. Other technology which may be in use by the broadcaster for broadcast purposes (Hot Spot, ball tracking, Snicko) shall not be permitted.

2 RUN OUT, STUMPING AND HIT WICKET DECISIONS

- 2.1 For televised matches, the on-field umpire shall be entitled to refer an appeal for a run-out, stumping or hit wicket to the third umpire.
- 2.2 For televised matches, an on-field umpire wishing to refer a decision to the third umpire shall signal to the third umpire by making the shape of a TV screen with their hands.
- 2.3 For televised matches, if the third umpire decides the batter is out a red light is displayed; a green light means not-out. Should the third umpire be temporarily unable to respond, a white light (where available) will remain illuminated throughout the period of interruption to signify to the on-field umpires that the TV replay system is temporarily unavailable, in which case the decision will be taken by the on-field umpire. (As an alternative to the red/green light system and where available, the big replay screen may be used for the purpose of conveying the third umpire's decision).
- 2.4 For televised matches, when reviewing the TV replay(s), the third umpire shall first check the fairness of the delivery (foot fault, bowler breaking the wicket, waist high full tosses, bouncers above shoulder height). Additionally, if the third umpire finds the batter is out by another mode of dismissal (excluding LBW), or not out by any mode of dismissal (excluding LBW), he shall notify the on-field umpire so that the correct decision is made.

- 2.5 For televised matches, Zing wickets are permitted to be used for run-out, stumping and hit wicket decisions (using the lights to determine if the wicket is broken)

3 CAUGHT DECISIONS

For televised matches, the on-field umpire shall be entitled to refer an appeal for a caught decision to the third umpire in the following circumstances:

3.1 Clean Catches

- a) Should the bowler's end umpire be unable to decide whether or not a catch was taken cleanly, they shall first consult with the square leg umpire.
- b) Should both umpires be unable to make a decision, they may consult by two-way radio with the 3rd umpire. Following such consultation, the final decision will be made and given by the bowler's end umpire, who will take into account the on-field umpires' initial views and any other advice received from the 3rd umpire.
- c) The third umpire has to determine whether the batter has been caught. However, when reviewing the television replay(s), the third umpire shall first check the fairness of the delivery (foot fault, bowler breaking the wicket, waist high full tosses, bouncers above shoulder height). Additionally, if it is clear to the third umpire that the batter did not hit the ball, or is not out by another mode of dismissal (excluding LBW), or out by any mode of dismissal (excluding LBW), he shall notify the on-field umpire so that the correct decision is made.

3.2 Bump Ball

- a) Should the bowler's end umpire be unable to decide whether a catch was taken from a bump ball or not, they shall first consult with the square leg umpire.
- b) Should both on-field umpires be unable to make a decision, the bowler's end umpire shall be entitled to refer the decision to the third umpire to review a TV replay(s) of the batter's stroke as in paragraph 2.2.
- c) The third umpire has to determine whether the ball was a bump ball or not. However, when reviewing the television replay(s), the third umpire shall first check the fairness of the delivery (foot fault and bowler breaking the wicket). Additionally, if it is clear to the third umpire that the batter did not hit the ball or is not out by another mode of dismissal (excluding LBW), or out by any mode of dismissal (excluding LBW), he shall notify the on-field umpire so that the correct decision is made.
- d) The third umpire shall communicate their decision by the system as in Clause 2 (c).

4 BOUNDARY DECISIONS

- 4.1 For televised matches, the on-field umpire shall be entitled to refer to the third umpire for a decision about whether the fielder had any part of her person in contact with the ball when she touched the boundary or when she had any part of her person grounded beyond the boundary or whether a four or six had been scored. A decision is to be made immediately and cannot be changed thereafter.

- 4.2 For televised matches, an on-field umpire wishing the assistance of the third umpire in this circumstance shall communicate with the third umpire by use of a two-way radio and the third umpire will convey their decision to the on-field umpire by this method.
- 4.3 For televised matches, the third umpire may initiate contact with the on-field umpire by two-way radio if TV coverage shows a boundary line infringement or incident that appears not to have been acted upon by the on-field umpires.

5 OBSTRUCTING THE FIELD

- a) Following an appeal from the fielding side, the on-field umpire shall be entitled to consult with the third umpire if he feels that the batter, in running between the wickets, may have significantly changed her direction (refer clause 37). An on-field umpire wishing to consult over a decision with the third umpire shall signal to the third umpire by making the shape of a TV screen with his hands.
- b) Such consultation shall be initiated by the on-field umpire and will be done to help him decide the extent of any change in direction and whether the obstruction was wilful or not.
- c) Following such consultation with the third umpire, the final decision shall be indicated in the normal fashion by the bowler's end umpire.

6 BATTER RUNNING TO THE SAME END

- 6.1 For televised matches, in the event of both batters running to the same end and the umpires are uncertain over which batter made her ground first, the on-field umpire may refer the decision to the third umpire.
- 6.2 The procedure in Clause 4.2 shall apply.

7 NO BALLS

If the on-field umpire is uncertain as the fairness of the delivery (foot-fault, bowler breaking the wicket, waist high full tosses, bouncers above shoulder height only), he shall be entitled to request the batter to delay leaving the field and to check the fairness of the delivery with the third umpire. Consultation with the third umpire shall be by way of two way radio. If the delivery was not a fair delivery the on-field umpire shall indicate that the batter is not-out and signal no-ball. For the avoidance of doubt, the third umpire shall apply clause 24.3 when deciding whether a no-ball should have been called.

APPENDIX 7A

Generic Camera Layout - Basic TV Coverage

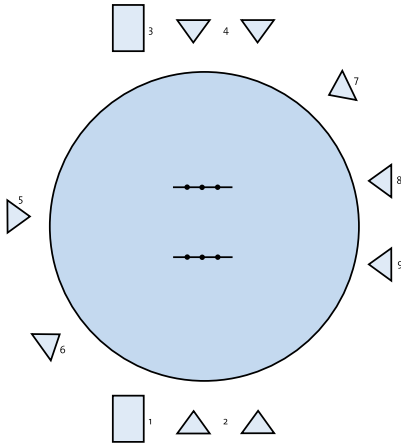

- 1 Wicket to Wicket
- 2 Follow
- 3 Wicket to Wicket
- 4 Follow
- 5 Square Leg/Mid Wicket
- 6 Slips
- 7 Slips
- 8 Line / Run out Cam
- 9 Line / Run out Cam

APPENDIX 7B

Generic Camera Layout - Third Umpire Coverage

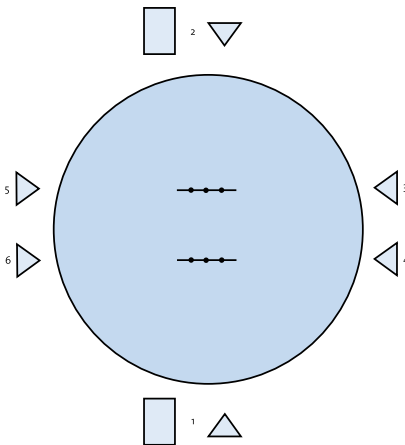

- 1 Follow
- 2 Follow
- 3 Line / Run out Cam
- 4 Line / Run out Cam
- 5 Line / Run out Cam
- 6 Line / Run out Cam

APPENDIX 8

Application of the Reserve Day

Example 1:

Match starts at 50 overs per side and there is an interruption at 19 overs. Overs are reduced to 46 overs per side and play is about to resume.

Before another ball is bowled it rains and play is abandoned for the day.

As the match didn't resume under the revised overs, the match should continue on the reserve day at the original 50 overs per side with the overs reduced if necessary during the day.

Example 2:

The same start as in example 1 i.e. match starts at 50 overs per side and there is an interruption at 19 overs. Overs are reduced to 46 overs per side and play is about to resume.

This time, play starts and after an over has been bowled it rains and play is abandoned for the day.

As the match has resumed, it is continued on the reserve day at 46 overs per side with the overs reduced if necessary during the day.

Example 3:

The toss occurs on the scheduled day but the match is abandoned for the day without a ball being bowled.

When play commences on the reserve day:

- The captains shall not be entitled to re-toss (and nominate new teams) unless by agreement between the two captains; and
- These matches shall always be regarded in the records as a single match.

Note: If the reserve day is utilised, the hours of play on the reserve day are the same as the scheduled hours of play on the scheduled day, including any provision for extra time. The amount of extra time available on the reserve day cannot exceed that which was available on the scheduled day.

WOMEN'S **TWENTY20**
PLAYING CONDITIONS

WOMEN'S TWENTY20 PLAYING CONDITIONS

These playing conditions are applicable to all Twenty20 Internationals from 1st October 2013 and supersede the previous version dated 30 April 2013. Included in this version are amendments to clauses 1.3, 2.2.2, 17.1, 17.2, 19.1, 19.3, 21.5, 23.1, 42.1, 42.1.1, Appendices 2, 3, 6 and 7 and new clauses 8.2, 24.3 and 42.1.2

Except as varied hereunder the Laws of Cricket (2000 Code 5th Edition - 2013) shall apply.

Note: All references to 'Governing Body' within the Laws of Cricket shall be replaced by 'ICC Match Referee'. The ICC Match Referee may or may not be present at the match.

1 LAW 1 - THE PLAYERS

1.1 Law 1.1 - Number of Players

Law 1.1 shall be replaced by the following:

A match is played between two sides. Each side shall consist of 11 players, one of whom shall be captain.

1.2 Law 1.2 - Nomination of Players

Law 1.2 shall be replaced by the following:

- 1.2.1 Each captain shall nominate 11 players plus a maximum of 4 substitute fielders in writing to the ICC Match Referee before the toss. No player (member of the playing eleven) may be changed after the nomination without the consent of the opposing captain.
- 1.2.2 Only those nominated as substitute fielders shall be entitled to act as substitute fielders during the match, unless the match referee, in exceptional circumstances, allows subsequent additions.
- 1.2.3 All those nominated including those nominated as substitute fielders, must be eligible to play for that particular team and by such nomination the nominees shall warrant that they are so eligible.
- 1.2.4 In addition, by their nomination, the nominees shall be deemed to have agreed to abide by all the applicable ICC Regulations pertaining to international cricket and in particular, the Clothing and Equipment Regulations, the Code of Conduct for Players and Player Support Personnel (hereafter referred to as the ICC Code of Conduct), the Anti-Racism Code for Players and Player Support Personnel, the Anti-Doping Code and the Anti-Corruption Code.

1.3 Law 1.3 – Captain

The following shall apply in addition to Law 1.3 (a):

The deputy must be one of the nominated members of the playing eleven.

Each Member Board must nominate its 'T20I Team Captain' to the ICC when appointed

If the 'T20I Team Captain' is not participating in a series, the relevant Home Board must nominate a replacement 'T20I Team Captain' for the series. The Home Board shall advise the series Referee.

If the 'T20I Team Captain' plays in a match without being the nominated captain for that match, she will be deemed to be the captain should any penalties be applied for over rate breaches under the Code of Conduct.

2 LAW 2 - SUBSTITUTES AND RUNNERS, BATTER OR FIELDER LEAVING THE FIELD, BATTER RETIRING, BATTER COMMENCING INNINGS

Law 2 shall apply subject to the following:

2.1 Law 2.1 Substitutes and Runners

Law 2.1 (a) (ii), 2.7 and 2.8 shall not apply. A runner for a batter when batting is not permitted.

Law 2.1 (b) shall be amended as follows:

The umpires shall have discretion to allow, for other wholly acceptable reasons, a substitute fielder to act for a nominated player. at the start of the match, or at any subsequent time.

2.2 Law 2.5 - Fielder absent or leaving the field

Law 2.5 shall be replaced by the following:

If a fielder fails to take the field with her side at the start of the match or at any later time, or leaves the field during a session of play, the umpire shall be informed of the reason for her absence, and she shall not thereafter come on to the field during a session of play without the consent of the umpire. (See Law 2.6 as modified). The umpire shall give such consent as soon as practicable.

If the player is absent from the field for longer than 8 minutes:

2.2.1 the player shall not be permitted to bowl in that innings after her return until she has been on the field for at least that length of playing time for which she was absent.

2.2.2 the player shall not be permitted to bat unless or until, in the aggregate, she has returned to the field and/or her side's innings has been in progress for at least that length of playing time for which she has been absent or, if earlier, when her side has lost five wickets.

The restriction in Clauses 2.1.1 and 2.1.2 above shall not apply if the player has suffered an external blow (as opposed to an internal injury such as a pulled muscle) whilst participating earlier in the match and consequently been forced to leave the field. Nor shall it apply if the player has been absent for very exceptional and wholly acceptable reasons (other than injury or illness).

In the event of a batter or a fielder already being off the field at the commencement of an interruption in play through ground, weather or light conditions or for other exceptional circumstances, she shall be allowed to count any such stoppage time as playing time, provided that she personally informs the umpires when she is fit enough to take the field had play been in progress. Similarly, if at the commencement of an interruption in play through ground, weather or light conditions or for other exceptional circumstances, a player is on the field but still has some unexpired penalty time remaining from a previous absence, he shall automatically be allowed to count any such stoppage time as playing time.

2.2.3 Substitute fielders shall only be permitted in cases of injury, illness or other wholly acceptable reasons. 'Wholly acceptable reasons' should be limited to extreme circumstances and should not include what is commonly referred to as a 'comfort break'.

Note: Squad members of the fielding team who are not playing in the match and who are not acting as substitute fielders shall be required to wear a team training bib whilst on the playing area (including the area between the boundary and the perimeter fencing).

3 LAW 3 - THE UMPIRES**3.1 Law 3.1 - Appointment and attendance**

Law 3.1 shall be replaced by the following:

The following rules for the selection and appointment of umpires shall be followed as far as it is practicable to do so:

- 3.1.1 Depending on the nature of the tournament, the Home Board shall appoint ICC approved umpires for on-field and third umpire duties. For televised matches the responsibility of the third umpire will be to act as an emergency umpire and officiate in regard to TV replays. For non-televised matches, the responsibility of the third umpire will be to act as an emergency umpire and carry out the tasks prescribed for the third and fourth umpires (note: a fourth umpire is not required for international women's matches)
- 3.1.2 Neither team will have a right of objection to an umpire's appointment.
- 3.1.3 The umpires shall be present at the ground at least 90 minutes before the scheduled start of play.

3.2 Third Umpires / TV Replays

The playing conditions set out in Appendix 6 shall apply.

3.3 Law 3.2 - Change of Umpire

The following shall apply in place of Law 3.2:

- 3.3.1 An umpire shall not be changed during the match, other than in exceptional circumstances, unless he is injured or ill.

3.4 Law 3.4 - To inform captains and scorers

In addition to Law 3.4 (i)

The host country may provide for the ringing of a bell, which shall be rung 5 minutes before the termination of an interval, when the umpires shall go to the wickets. The host country shall inform the ICC Match Referee (if one is present and on duty at the ground) and the visiting country at the start of the tour that this practice is to be adopted.

3.5 Law 3.8 - Fitness of play and Law 3.9 - Suspension of in dangerous or unreasonable conditions

- 3.5.1 The safety of all persons within the ground is of paramount importance to the ICC. In the event that any threatening circumstance, whether actual or perceived, comes to the attention of any umpire (including for example weather, pitch invasions, act of God, etc see also clauses 3.5.4 and 3.5.5 below), then the players and officials should immediately be asked to leave the field of play in a safe and orderly manner and to relocate to a secure and safe area (depending on each particular threat) pending the satisfactory passing or resolution of such threat or risk to the reasonable satisfaction of the umpires, ICC Match Referee, the head of the relevant ground authority, the head of ground security and/or the police as the circumstances may require. See also clause 3.6 below.

Laws 3.8 & 3.9 shall be replaced by:

- 3.5.2 The umpires shall be the final judges of the fitness of the ground, weather and light for play. See clause 3.5.3 below and Law 7.2 (Fitness of the pitch for play).

3.5.3 Suspension of play for adverse conditions of ground, weather or light

- a) (i) All references to ground include the pitch. See Law 7.1 (Area of pitch).
- b) If at any time the umpires together agree that the conditions of ground, weather or light are so bad that there is obvious and foreseeable risk to the safety of any player or umpire, so that it would be unreasonable or dangerous for play to take place, then they shall immediately suspend play, or not allow play to commence or to restart. The decision as to whether conditions are so bad as to warrant such action is one for the umpires alone to make.

The fact that the grass and the ball are wet and slippery does not warrant the ground conditions being regarded as unreasonable or dangerous. If the umpires consider the ground is so wet or slippery as to deprive the bowler of a reasonable foothold, the fielders of the power of free movement, or the batsmen of the ability to play their strokes or to run between the wickets, then these conditions shall be regarded as so bad that it would be unreasonable for play to take place.

The Umpires shall disregard any shadow on the pitch from the stadium or from any permanent object on the ground.

- c) When there is a suspension of play it is the responsibility of the umpires to monitor the conditions. They shall make inspections as often as appropriate, unaccompanied by any of the players or officials. Immediately the umpires together agree that conditions are suitable for play they shall call upon the players to resume the game.
- d) If play is in progress up to the start of an agreed interval then it will resume after the interval unless the umpires together agree that the conditions of ground, weather or light are so bad that there is obvious and foreseeable risk to the safety of any player or umpire, so that it would be unreasonable or dangerous for play to take place.

3.5.4 Play may be suspended due to safety and security concerns by the umpires on the advice of the ICC Match Referee (if one is present and on duty at the match), the head of the relevant ground authority, the head of ground security or the police.

3.5.5 Where play is suspended under Clause 3.5.4 above the decision to abandon or resume play shall be the responsibility of the ICC Match Referee (or umpires if no match referee is present and on duty at the match) who shall act only after consultation with the head of ground security and the police.

3.6 Light Meters

- 3.6.1 It is the responsibility of each Home Board to supply light meters to all umpires standing in international matches in accordance herewith.
- 3.6.2 All light meters shall be uniformly calibrated.
- 3.6.3 The umpires shall be entitled to use light meter readings as a guideline for determining whether the light is fit for play in accordance with the criteria set out in clause 3.5.3 (b) above.

- 3.6.4 Light meter readings may accordingly be used by the umpires:
- To determine whether there has been at any stage a deterioration or improvement in the light.
 - As benchmarks for the remainder of a stoppage, match and/or series/event.

3.7 Use of artificial lights

In the event of power failure or lights malfunction, the provisions relating to the delay or interruption of play due to bad weather or light shall apply.

3.8 Colours

- 3.8.1 Pads and players' and umpires' clothing shall be coloured.
- 3.8.2 Sight screens will be black.

3.9 Advertising on grounds, perimeter boards and sightscreens

3.9.1 Advertising on grounds

The logos on outfielders are to be positioned as follows:

- Behind the stumps – a minimum of 25.15 yards (23 meters) from the stumps.
- Midwicket/cover area – no advertising to be positioned within the 25.15 yards (23 meters) circle.

Note: Advertising closer to the stumps as set out above which is required to meet 3D requirements for broadcasters may be permitted, subject to prior ICC approval having been obtained.

3.9.2 Perimeter Boards

- Advertising on perimeter boards placed in front of the sightscreens is permitted save that the predominant colour of such advertising shall be of a contrasting colour to that of the ball.
- Advertising on perimeter boards behind the stumps at both ends shall not contain moving, flashing or flickering images and operators should ensure that the images are only changed or moved at a time that will not be distracting to the players or the umpires.
- In addition, the brightness of any electronic images shall be set at a level so that it is not a distraction to the players or umpires.

3.9.3 Sightscreens

- Sightscreens shall be provided at both ends of all grounds.
- Advertising shall be permitted on the sightscreen behind the striker, providing it is removed for the subsequent over from that end.
- Such advertising shall not contain flashing or flickering images and particular care should be taken by the operators that the advertising is not changed at a time which is distracting to the umpire.

4 LAW 4 - THE SCORERS

Law 4 shall apply.

5 LAW 5 - THE BALL

5.1 Law 5.2 - Approval and control of balls

Law 5.2 shall be replaced by the following:

The Home Board shall provide the best available high quality cricket balls (e.g. Kookaburra 'Turf' or its equivalent) and spare used balls for changing during a match, which shall also be of the same brand. Note: The Home Board shall be required to advise the visiting Boards of the brand of ball to be used in the match(es) at least 30 days prior to the start of the match(es).

The fielding captain or her nominee may select the ball with which she wishes to bowl from the supply provided by the Home Board. The third umpire shall take a box containing at least 6 new balls to the dressing room and supervise the selection of the ball.

The umpires shall retain possession of the match ball(s) throughout the duration of the match when play is not actually taking place. During play umpires shall periodically and irregularly inspect the condition of the ball and shall retain possession of it at the fall of a wicket or any other disruption in play. Where day/night matches are scheduled in a series white balls will be used in all matches (including day matches). Each fielding team shall have one new ball for its innings.

5.2 Law 5.4 - New ball in match of more than one day's duration

Law 5.4 shall not apply.

5.3 Law 5.5 - Ball lost or becoming unfit for play

Law 5.5 shall be replaced by the following:

In the event of a ball during play being lost or in the opinion of the umpires, being unfit for play through normal use, the umpires shall allow it to be replaced by one that in their opinion has had a similar amount of wear.

In the event of the ball becoming wet and soggy as a result of play continuing in inclement weather or it being affected by dew, or a white ball becoming significantly discoloured and in the opinion of the umpires being unfit for play, the ball may be replaced for a ball that has similar amount of wear, even though it has not gone out of shape.

If the ball is to be replaced, the umpire shall inform the batter and the fielding captain. Either batter or bowler may raise the matter with the umpires and the umpires' decision as to a replacement or otherwise will be final.

5.4 Law 5.6 - Specifications

Law 5.6 shall not apply.

6 LAW 6 - THE BAT

The following shall apply in addition to Law 6

Only Type A bats shall be used in Twenty20 International matches.

7 LAW 7 - THE PITCH

7.1 Law 7.3 - Selection and preparation

The following will apply in addition to Law 7.3:

7.1.1 The ground staff shall ensure that during the period prior to the start of play and during intervals, the pitch area shall be roped off so as to prevent unauthorised access. (The pitch area shall include an area at least 2 metres beyond the rectangle made by the crease markings at both ends of the pitch).

- 7.1.2 The third umpire shall ensure that, prior to the start of play and during any intervals, only authorised ground staff, the ICC match officials, players, team coaches and authorised television personnel shall be allowed access to the pitch area. Such access shall be subject to the following limitations:
- Only captains and team coaches may walk on the actual playing surface of the pitch area (outside of the crease markings).
 - Access to the pitch area by television personnel shall be restricted to one camera crew (including one or two television commentators) of the official licensed television broadcaster(s) (but not news crews).
 - No spiked footwear shall be permitted.
 - No one shall be permitted to bounce a ball on the pitch, strike it with a bat or cause damage to the pitch in any other way.
 - Access shall not interfere with pitch preparation.
- 7.1.3 In the event of any dispute, the ICC Match Referee will rule and his ruling will be final.

7.2 Law 7.4 - Changing the pitch

The following shall apply, except that the reference to ICC Match Referee will only apply if one is present and on duty at the ground.

Law 7.4 shall be replaced by the following:

- 7.2.1 In the event of a pitch being considered too dangerous for play to continue in the estimation of the on-field umpires, they shall stop play and immediately advise the ICC Match Referee.
- 7.2.2 The on-field umpires and ICC Match Referee shall consult with both captains.
- 7.2.3 If the captains agree to continue, play shall resume.
- 7.2.4 If the decision is not to resume play, the on-field umpires together with the ICC Match Referee or umpires shall consider whether the existing pitch can be repaired and the match resumed from the point it was stopped. In considering whether to authorise such repairs, the ICC Match Referee or umpires must consider whether this would place either side at an unfair advantage, given the play that had already taken place on the dangerous pitch.
- 7.2.5 If the decision is that the existing pitch cannot be repaired, then the match is to be abandoned with the following consequences:
- In the event of the required number of overs to constitute a match having been completed at the time the match is abandoned, the result shall be determined according to the provisions of clause 21.7.2.
 - In the event of the required number of overs to constitute a match not having been completed, the match will be abandoned as a no result.
- 7.2.6 If the match is abandoned as a no result, the ICC Match Referee or umpires shall consult with the Home Board with the objective of finding a way for a new match to be commenced and completed on the same date (including any reserve day) and venue.

- 7.2.7 Such a match may be played either on the repaired pitch or on another pitch, subject to the ICC Match Referee or umpires and the relevant ground authority both being satisfied that the new pitch will be of the required ODI standard. The playing time lost between the scheduled start time of the original match and the actual start time of the new match will be covered by the provisions of clauses 12 and 16 below.
- 7.2.8 If it is not possible to play a new match on the scheduled day of the match (including any reserve day), the relevant officials from the participating Boards shall agree on whether the match can be replayed within the existing tour schedule.
- 7.2.9 Throughout the above decision making processes, the ICC Match Referee or umpires shall keep informed both captains and the head of the ground authority. The head of the ground authority shall ensure that suitable and prompt public announcements are made.

7.3 Law 7.5 - Non-turf pitches

Law 7.5 shall not apply.

All matches shall be played on natural turf pitches. The use of PVA and other adhesives in the preparation of pitches is not permitted.

8 LAW 8 - THE WICKETS

8.1 Law 8.2 - Size of stumps

The following shall apply in addition to Law 8.2:

For televised matches the Home Board may provide a slightly larger cylindrical stump to accommodate the stump camera. When the larger stump is used, all three stumps must be exactly the same size.

8.2 Zing Wickets

For televised matches, the use of Zing wickets is permitted.

Refer also to Appendix 6 clause 2.5.

9 LAW 9 - THE BOWLING, POPPING AND RETURN CREASES

9.1 Law 9.3 - The Popping Crease

Law 9.3 shall apply, except that the reference to 'a minimum of 6 ft' shall be replaced by 'a minimum of 15 yards (13.71 metres)'.

9.2 Additional Crease Markings

The following shall apply in addition to Law 9:

As a guideline to the umpires for the calling of wides on the offside the crease markings detailed in Appendix 4 shall be marked in white at each end of the pitch.

10 LAW 10 - PREPARATION AND MAINTENANCE OF THE PLAYING AREA

10.1 Law 10.1 - Rolling

The following shall apply in addition to Law 10.1:

- 10.1.1 Prior to tossing for choice of innings the artificial drying of the pitch and outfield shall be at the discretion of the ground curator. Thereafter and throughout the match the drying of the outfield may be undertaken at any time by the ground curator, but the

drying of the affected area of the pitch shall be carried out only on the instructions and under the supervision of the umpires. The umpires shall be empowered to have the pitch dried without reference to the captains at any time they are of the opinion that it is unfit for play.

- 10.1.2 The umpires may instruct the ground curator to use any available equipment, including any roller for the purpose of drying the pitch and making it fit for play.
- 10.1.3 An absorbent roller may be used to remove water from the covers including the cover on the match pitch.

10.2 Law 10.6 - Maintenance of foot holes

The following shall apply in addition to Law 10.6:

The umpires shall see that wherever possible and whenever it is considered necessary, action is taken during all intervals in play to do whatever is practicable to improve the bowler's foot holes.

10.3 Protection and preparation of adjacent pitches during matches

The protection (by way of an appropriate cover) and preparation of pitches which are adjacent to the match pitch will be permitted during the match subject to the following:

- 10.3.1 Such measures will only be possible if requested by the ground curator and approved by the umpires before the start of the match.
- 10.3.2 Approval should only be granted where such measures are unavoidable and will not compromise the safety of the players or their ability to execute their actions with complete freedom.
- 10.3.3 The preparation work shall be carried out under the supervision of the fourth umpire.
- 10.3.4 Any necessary watering shall be carried out only to the extent necessary for such preparations and shall not be permitted in circumstances which may in any way affect the match pitch.
- 10.3.5 The consent of the captains is not required but the umpires shall advise both captains and the ICC Match Referee (if one is present and on duty at the ground) before the start of the match on what has been agreed.

11 LAW 11 - COVERING THE PITCH

11.1 Law 11.1 - Before the match

The following shall apply in addition to Law 11.1:

The pitch shall be entirely protected against rain up to commencement of play.

11.2 Law 11.2 - During the match

Law 11.2 shall be replaced by the following:

The pitch shall be entirely protected against rain up to the commencement of play and for the duration of the period of the match.

The covers must totally protect the pitch and also the pitch surroundings, a minimum 5 metres either side of the pitch and any worn or soft areas in the outfield.

11.3 Law 11.3 - Covering bowlers' run ups

Law 11.3 shall be replaced by the following:

The bowler's run-ups shall be covered, in inclement weather, in order to keep them dry, to a distance of at least 10 x 10 metres.

11.4 Law 11.4 - Removal of covers

Law 11.4 shall be replaced by the following:

All covers (including "hessian" or "scrim" covers used to protect the pitch against the sun) shall be removed not later than 2½ hours before the scheduled start of play provided it is not raining at the time, but the pitch will be covered again if rain falls prior to the commencement of play.

Attention is drawn to clauses 3.5 and 10.3 above.

12 LAW 12 - INNINGS

Law 12 shall apply subject to the following (see also clauses 15 and 16 below):

12.1 Law 12.1 - Number of innings

Law 12.1 shall be replaced by the following:

All matches will consist of one innings per side, each innings being limited to a maximum of 20 overs. All matches shall be of one day's scheduled duration.

12.2 Law 12.2 - Alternate innings

Law 12.2 shall not apply.

12.3 Law 12.3 - Completed innings

Laws 12.3 (c), (d) and (e) (iii) shall not apply.

12.4 Length of Innings

12.4.1 Uninterrupted Matches.

- a) Each team shall bat for 20 overs unless all out earlier.
- b) If the team fielding first fails to bowl the required number of overs by the scheduled time for cessation of the first innings, play shall continue until the required number of overs has been bowled. The interval shall not be extended and the second session shall commence at the schedule time. The team batting second shall receive its full quota of 20 overs irrespective of the number of overs it bowled in the scheduled time for the cessation of the first innings.
- c) If the team batting first is dismissed in less than 20 overs, the team batting second shall be entitled to bat for 20 overs.
- d) If the team fielding second fails to bowl 20 overs by the scheduled cessation time, the hours of play shall be extended until the required number of overs has been bowled or a result is achieved.
- e) Penalties shall apply for slow over rates (refer ICC Code of Conduct).

12.4.2 Delayed or Interrupted Matches

- a) Delay or Interruption to the Innings of the Team Batting First (see Appendix 2)
 - i) When playing time has been lost the revised number of overs to be bowled in the match shall be based on a rate of 16 overs per hour in the total time available for play.
 - ii) The revision of the number of overs should ensure, whenever possible, that both teams have the opportunity of batting for the same number of overs. The team batting second shall not bat for a greater number of overs than the first team unless the latter completed its innings in less than its allocated overs. To constitute a match, a minimum of 5 overs have to be bowled to the side batting second, subject to a result not being achieved earlier.
 - iii) As soon as the total minutes of playing time remaining is less than the completed overs faced by Team 1 multiplied by 3.8, then the first innings is terminated and the provisions of 12.4.2 b) below take effect
 - iv) A fixed time will be specified for the commencement of the interval, and also the close of play for the match, by applying a rate of 16 overs per hour. When calculating the length of playing time available for the match, or the length of either innings, the timing and duration of all relative delays, extensions in playing hours, interruptions in play, and the interval will be taken into consideration. This calculation must not cause the match to finish earlier than the original or rescheduled time for cessation of play on the final scheduled day for play. If required the original time shall be extended to allow for one extra over for each team.
 - v) If the team fielding first fails to bowl the revised number of overs by the specified time, play shall continue until the required number of overs have been bowled or the innings is completed.
 - vi) Penalties shall apply for slow over rates (refer to ICC Code of Conduct).
- b) Delay or Interruption to the innings of the Team Batting Second (see Appendix 3)
 - i) When playing time has been lost and, as a result, it is not possible for the team batting second to have the opportunity of receiving its allocated, or revised allocation of overs in the playing time available, the number of overs shall be reduced at a rate of 16 overs per hour in respect of the lost playing time. Should the calculations result in a fraction of an over the fraction shall be ignored.
 - ii) In addition, should the innings of the team batting first have been completed prior to the scheduled, or re-scheduled time for the commencement of the interval, then any calculation relating to the revision of overs shall not be effective until an amount of time equivalent to that by which the second innings started early has elapsed.
 - iii) To constitute a match, a minimum of 5 overs have to be bowled to the team batting second subject to a result not being achieved earlier.

- iv) The team batting second shall not bat for a greater number of overs than the first team unless the latter completed its innings in less than its allocated overs.
- v) A fixed time will be specified for the close of play by applying a rate of 16 overs per hour. The timing and duration of all relative delays, extensions in playing hours and interruptions in play, will be taken into consideration in specifying this time.
- vi) If the team fielding second fails to bowl the revised overs by the scheduled or re-scheduled close of play, the hours of play shall be extended until the overs have been bowled or a result achieved.
- vii) Penalties shall apply for slow over rates (refer ICC Code of Conduct).

12.5 Extra Time

The participating countries may agree to provide for extra time where the start of play is delayed or play is suspended.

12.6 Number of Overs per Bowler

No bowler shall bowl more than 4 overs in an innings.

In a delayed or interrupted match where the overs are reduced for both teams or for the team bowling second, no bowler may bowl more than one-fifth of the total overs allowed.

Where the total overs are not divisible by 5, one additional over shall be allowed to the maximum number per bowler necessary to make up the balance.

In the event of a bowler breaking down and being unable to complete an over, the remaining balls will be allowed by another bowler. Such part of an over will count as a full over only in so far as each bowler's limit is concerned.

The scoreboard shall show the total number of overs bowled and the number of overs bowled by each bowler.

12.7 Law 12.4 - The toss

Law 12.4 shall be replaced by the following:

The captains shall toss for the choice of innings, on the field of play and in the presence of the ICC Match Referee (if one is present and on duty at the ground) or an umpire, who shall supervise the toss. The toss shall take place not earlier than 30 minutes, nor later than 15 minutes before the scheduled or any rescheduled time for the match to start. Note, however, the provisions of Law 1.3 (Captain).

Note: Law 12.5 requiring the captain of the side winning the toss to notify the opposing captain as soon as the toss is completed of his decision to bat or to field shall apply.

13 LAW 13 - THE FOLLOW-ON

Law 13 shall not apply.

14 LAW 14 - DECLARATION AND FORFEITURE

Law 14 shall not apply.

15 LAW 15 - INTERVALS

Law 15 shall apply subject to the following:

15.1 Law 15.5 - Changing agreed times for intervals - Interval between Innings

If the innings of the team batting first is completed prior to the scheduled time for the interval, the interval shall take place immediately and the innings of the team batting second will commence correspondingly earlier. In circumstances where the side bowling first has not completed the allotted number of overs by the scheduled or re-scheduled cessation time for the first innings, the umpires shall reduce the length of the interval by the amount of time that the first innings over-ran. The minimum time for the interval will be 10 minutes.

However, following a lengthy delay or interruption prior to the completion of the innings of the team batting first, the Match Referee (or umpires if no Match Referee is present) may, at their discretion, reduce the interval between innings from 15 minutes to not less than 10 minutes.

Such discretion should only be exercised after determining the adjusted overs per side based on a 15 minute interval. If having exercised this discretion, the rescheduled finishing time for the match is earlier than the latest possible finishing time, then these minutes should be deducted from the length of any interruption during the second innings before determining the overs remaining.

15.2 Law 15.9 - Intervals for drinks

No drinks intervals shall be permitted.

An individual player may be given a drink either on the boundary edge or at the fall of a wicket, on the field, provided that no playing time is wasted. No other drinks shall be taken onto the field without the permission of the umpires. Any player taking drinks onto the field shall be dressed in proper cricket attire (subject to the wearing of bibs – see clause 2.1.3).

16 LAW 16 - START OF PLAY; CESSATION OF PLAY

Law 16 shall apply subject to the following (see also clauses 15 and 12.4):

16.1 Law 16.1 – Start and Cessation Times

To be determined by the Home Board subject to there being 2 sessions of 1 hour 15 minutes each, separated by a 15 minute interval between innings.

16.2 Minimum Over Rates

The minimum over rate to be achieved in a T20I match will be 16 overs per hour.

The actual over rate will be calculated at the end of the match by the umpires.

In calculating the actual over rate for the match, allowances will be given for the actual time lost as a result of any of the following:

- a) treatment given to a player by an authorised medical personnel on the field of play;
- b) a player being required to leave the field as a result of a serious injury;
- c) all third umpire referrals and consultations;
- d) time wasting by the batting side; and
- e) all other circumstances that are beyond the control of the fielding side.

In the event of any time allowances being granted to the fielding team under 16.2 (d) above (time wasting by batting team), then such time shall be deducted from the allowances granted to such batting team in the determination of its over rate.

In addition to the allowances as provided for above,

- in the case of an innings that has been reduced due to any delay or interruption in play, an additional allowance of 1 minute for every full 3 overs by which the innings is reduced will be granted.
- an additional allowance of 1 minute will be given for each of the 6th, 7th, 8th and 9th wickets taken during an innings.

If a side is bowled out within the time determined for that innings pursuant to these playing conditions (taking into account all of the time allowances set out above), the fielding side will be deemed to have complied with the required minimum over rate.

17 LAW 17 - PRACTICE ON THE FIELD

Law 17 shall apply subject to the following:

17.1 Law 17.1 – Practice on the pitch or the rest of the square

- a) The use of the square for practice on any day of any match will be restricted to any netted practice area or bowling strips specifically prepared on the edge of the square for that purpose.
- b) Bowling practice on the bowling strips referred to in (a) above shall also be permitted during the interval (and change of innings if not the interval) unless the umpires consider that, in the prevailing conditions of ground and weather, it will be detrimental to the surface of the square.

17.2 Law 17.3 - Practice on the outfield between the call of play and the call of time

Law 17.3 shall apply save that Law 17.3 (c) shall be replaced with the following:

- c) There shall be no bowling or batting practice on the outfield. Bowling a ball, using a short run up to a player in the outfield is not to be regarded as bowling practice but shall be subject to the law.

18 LAW 18 - SCORING RUNS

Law 18 shall apply.

19 LAW 19 - BOUNDARIES

Law 19 shall apply subject to the following:

19.1 Law 19.1 - The boundaries of the field of play

The following shall apply in addition to Law 19.1:

The boundary shall be a minimum of 55 yards (50.29 metres) and a maximum of 65 yards (59.44 metres). Distances shall be measured from the centre of the pitch.

Any ground on which a Test or One Day International has been played prior to 1st July 1995 which can not conform with these minimum dimensions shall be exempt from this playing condition. Any new ground must conform to these minimum dimensions.

19.2 Law 19.2 - Defining the boundary - boundary marking

The following shall apply in addition to Law 19.2:

All boundaries must be designated by a rope or similar object of a minimum standard as authorised by the ICC from time to time. Where appropriate the rope should be a required minimum distance (3 yards (2.74 metres) minimum) inside the perimeter fencing or advertising signs.

19.3 Law 19.3 - Scoring a boundary

The following shall apply in addition to Law 19.3:

If an unauthorized person enters the playing arena and handles the ball, the umpire at the bowler's end shall be the sole judge of whether the boundary allowance should be scored or the ball be treated as still in play or called dead ball if a batter is liable to be out as a result of the unauthorized person handling the ball. See also Law 19.1 (c).

20 LAW 20 - LOST BALL

Law 20 shall apply.

21 LAW 21 - THE RESULT

Law 21 shall apply subject to the following:

21.1 Law 21.1 - A win - two innings match

Law 21.1 shall not apply.

21.2 Law 21.2 - A win - one innings match

Law 21.2 shall apply in addition to the following:

- 21.2.1 Save for circumstances where a match is awarded to a team as a consequence of the opposing teams refusal to play (Law 21.3), a result can be achieved only if both teams have had the opportunity of batting for at least 5 overs, unless one team has been all out in less than 5 overs or unless the team batting second scores enough runs to win in less than 5 overs.
- 21.2.2 Save for circumstances where a match is awarded to a team as a consequence of the opposing teams refusal to play (Law 21.3), all matches in which both teams have not had an opportunity of batting for a minimum of 5 overs, shall be declared no result.

21.3 Law 21.3 – Umpire (ICC Match Referee) awarding a match

Law 21.3 shall be replaced by the following:

- a) A match shall be lost by a side which either
 - i) concedes defeat or
 - ii) in the opinion of the ICC Match Referee refuses to play and the ICC Match Referee shall award the match to the other side.
- b) If an umpire considers that an action by any player or players might constitute a refusal by either side to play then the umpires together shall inform the ICC Match Referee of this fact. The ICC Match Referee shall together with the umpires ascertain the cause of the action. If the ICC Match Referee, after due consultation with the umpires, then decides that this action does constitute a refusal to play by one side, he shall so inform the captain of that side. If the captain persists in the action the Referee shall award the match in accordance with (a)(ii) above.*

- c) If action as in (b) above takes place after play has started and does not constitute a refusal to play the delay or interruption in play shall be dealt with in the same manner as provided for in clauses 12.4.2 and 15.1 above.

* N/B In addition to the consequences of any refusal to play prescribed under this clause, any such refusal, whether temporary or final, may result in disciplinary action being taken against the captain and team responsible under the Code of Conduct.

21.4 Law 21.4 – Matches in which there is an agreement under Law 12.1 (b)

Law 21.4 shall not apply.

21.5 Law 21.5 (a) - A Tie

The following shall apply in addition to Law 21.5 (a):

If the scores are equal, the result will be a tie and no account shall be taken of the number of wickets which have fallen. In the event of a tied match the teams shall compete in a Super Over to determine the winner. Refer attached Appendix 7.

21.6 Law 21.5 (b) - A Draw

Law 21.5 shall not apply.

21.7 Interrupted or Prematurely Terminated Matches - Calculation of the Target Score

21.7.1 Interrupted Matches - Calculation of the Target Score

If, due to suspension of play after the start of the match, the number of overs in the innings of either team has to be revised to a lesser number than originally allotted (minimum of 5 overs), then a revised target score (to win) should be set for the number of overs which the team batting second will have the opportunity of facing. This revised target is to be calculated using the current Duckworth/Lewis method. The target set will always be a whole number and one run less will constitute a Tie. (Refer Duckworth/Lewis Regulations)

21.7.2 Prematurely Terminated Matches

If the innings of the side batting second is suspended (with at least 5 overs bowled) and it is not possible for the match to be resumed, the match will be decided by comparison with the D/L 'Par Score' determined at the instant of the suspension by the Duckworth/Lewis method (refer Duckworth/Lewis Regulations). If the score is equal to the par score, the match is a Tie. Otherwise the result is a victory, or defeat, by the margin of runs by which the score exceeds, or falls short of, the Par Score.

21.8 Correctness of result

Any query on the result of the match as defined in Laws 21.2, 21.3, 21.4, 21.8 and 21.10 (as modified by these regulations) shall be resolved as soon as possible and a final decision made by the umpires at close of play.

22 LAW 22 – THE OVER

Law 22 shall apply subject to the addition of the following to Law 22.5:

22.1 Law 22.5 - Umpire miscounting

Whenever possible the third umpire shall liaise with the scorers and if possible inform the on-field umpires if the over has been miscounted.

23 LAW 23 - DEAD BALL

Law 23 shall apply subject to the addition of the following to Law 23.4.

In a match where cameras are being used on or over the field of play (e.g. Spydercam), should a ball that has been hit by the batter make contact, while still in play, with the camera, its apparatus or its cable, either umpire shall call and signal 'dead ball'. The ball shall not count as one of the over and no runs shall be scored. If the delivery was called a no ball it shall count and the no ball penalty applied, including if appropriate a free hit from the next delivery. No other runs (including penalty runs) apart from the no ball penalty shall be scored.

Should a ball thrown by a fielder make contact with a camera on or over the field of play, its apparatus or its cable, either umpire shall call and signal dead ball. Unless this was already a no-ball or wide, the ball shall count as one of the over. All runs scored to that point shall count, plus the run in progress if the batters have already crossed.

24 LAW 24 - NO BALL

Law 24 shall apply subject to the following:

24.1 Law 24.1 (b) Mode of delivery

Law 24.1 (b) shall be replaced by the following:

The bowler may not deliver the ball underarm. If a bowler bowls a ball underarm the umpire shall call and signal no ball, and the ball is to be re-bowled overarm.

24.2 Free Hit after a foot-fault no ball

In addition to the above, the delivery following a no ball called for a foot fault (Law 24.5) shall be a free hit for whichever batter is facing it. If the delivery for the free hit is not a legitimate delivery (any kind of no ball or a wide ball), then the next delivery will become a free hit for whichever batter is facing it.

For any free hit, the striker can be dismissed only under the circumstances that apply for a no ball, even if the delivery for the free hit is called wide ball.

Field changes are not permitted for free hit deliveries unless there is a change of striker (the provisions of clause 41.2 shall apply).

The umpires will signal a free hit by (after the normal No Ball signal) extending one arm straight upwards and moving it in a circular motion.

24.3 Fair Delivery - the feet

Law 24.5 shall apply, subject to the final paragraph being replaced by the following:

If the bowler's end umpire is satisfied that any of these conditions have not been met, he shall call and signal No ball.

25 LAW 25 - WIDE BALL

25.1 Law 25.1 - Judging a Wide

Law 25 shall apply with the following addition to Law 25.1:

Umpires are instructed to apply very strict and consistent interpretation in regard to this Law in order to prevent negative bowling wide of the wicket.

Any offside or legside delivery which in the opinion of the umpire does not give the batter a reasonable opportunity to score shall be called a wide.

A penalty of one run for a wide shall be scored. This penalty shall stand in addition to any other runs which are scored or awarded. All runs, which are run or result from a wide ball, which is not a no ball, shall be scored wide balls.

26 LAW 26 - BYE AND LEG BYE

Law 26 shall apply.

27 LAW 27 - APPEALS

Law 27 shall apply.

28 LAW 28 - THE WICKET IS DOWN

Law 28 shall apply.

29 LAW 29 - BATTER OUT OF HER GROUND

Law 29 shall apply.

If the running batter has grounded any part of her foot behind the popping crease, then any subsequent loss of contact with the ground of her person or bat, during her continuing forward momentum, should not be interpreted as being 'out of her ground'.

30 LAW 30 - BOWLED

Law 30 shall apply.

31 LAW 31 - TIMED OUT

Law 31 will apply except that the incoming batter must be in position to take guard or for her partner to be ready to receive the next ball within 1 minute 30 seconds of the fall of the previous wicket. The incoming batter is expected to be ready to make her way to the wicket immediately a wicket falls.

Dugouts shall be provided.

32 LAW 32 - CAUGHT

Law 32 shall apply.

33 LAW 33 - HANDLED THE BALL

Law 33 shall apply.

34 LAW 34 - HIT THE BALL TWICE

Law 34 shall apply.

35 LAW 35 - HIT WICKET

Law 35 shall apply.

36 LAW 36 - LEG BEFORE WICKET

Law 36 shall apply.

37 LAW 37 - OBSTRUCTING THE FIELD

Law 37 shall apply. For the avoidance of doubt, if an umpire feels that a batter, in running between the wickets, has significantly changed his direction without probable cause and thereby obstructed a fielder's attempt to effect a run out, the batter should, on appeal, be given out, obstructing the field. It shall not be relevant whether a run out would have occurred or not.

If the change of direction involves the batter crossing the pitch, Law 42.14 shall also apply.

38 LAW 38 - RUN OUT

Law 38 shall apply.

39 LAW 39 - STUMPED

Law 39 shall apply.

40 LAW 40 - THE WICKET-KEEPER

Law 40 shall apply.

41 LAW 41 - FIELDER

Law 41 shall apply subject to the following:

41.1 Law 41.1 - Protective equipment

The following shall apply in addition to Law 41.1:

The exchanging of protective equipment between members of the fielding side on the field shall be permitted provided that the umpires do not consider that it constitutes a waste of playing time.

41.2 Restrictions on the placement of fielders

- 41.2.1 At the instant of delivery, there may not be more than 5 fielders on the leg side.
- 41.2.2 In addition to the restriction contained in clause 41.2.1 above, further fielding restrictions shall apply to certain overs in each innings. The nature of such fielding restrictions and the overs during which they shall apply (hereinafter referred to as the Powerplay overs) are set out in the following paragraphs.
 - a) Subject to 41.2.3 below these additional fielding restrictions shall apply to the first 6 overs of each innings (Powerplay Overs)
 - b) Two semi-circles shall be drawn on the field of play. The semi-circles shall have as their centre the middle stump at either end of the pitch. The radius of each of the semi-circles shall be 25.15 yards (23 metres). The semi-circles shall be linked by two parallel straight lines drawn on the field. (Refer attached Appendix 5). The fielding restriction areas should be marked by continuous painted white lines or 'dots' at 5 yard (4.57 metres) intervals, each 'dot' to be covered by a white plastic or rubber (but not metal) disc measuring 7 inches (18 cm) in diameter. During the Fielding Restriction Overs (as set out below), only two fielders shall be permitted outside this fielding restriction area at the instant of delivery.

- c) During Powerplay Overs only two fielders shall be permitted outside this fielding restriction area at the instant of delivery.
 - d) During the non Powerplay Overs, no more than 5 fielders shall be permitted outside the fielding restriction area referred to in clause 41.1.1 b above.
- 41.2.3 In circumstances where the number of overs of the batting team is reduced, the number of Powerplay Overs shall be reduced in accordance with the table below. For the sake of clarity, it should be noted that the table shall apply to both the 1st and 2nd innings of the match.

TOTAL OVERS IN INNINGS	NO. OF OVERS FOR WHICH FIELDING RESTRICTIONS IN CLAUSES 41.2.2 (a) & 41.2.2 (c) ABOVE WILL APPLY
5-8	2
9-11	3
12-14	4
15-18	5
19-20	6

- 41.2.4 If an innings is interrupted during an over and if on the resumption of play, due to the reduced number of overs of the batting team, the required number of Powerplay Overs have already been bowled, the remaining deliveries in the over to be completed shall not be subject to the fielding restrictions.
- 41.2.5 In the event of an infringement of any of the above fielding restrictions, the square leg umpire shall call and signal 'No Ball'.

42 LAW 42 - FAIR AND UNFAIR PLAY

42.1 Law 42.3 - The Match Ball - changing its condition

Law 42.3 shall apply, subject to the following:

Law 42.3 (d) and (e) shall be replaced with the following:

If the umpires together agree that the deterioration of the ball is inconsistent with the use it has received, they shall consider that there has been a contravention of this Law. They shall then decide together whether they can identify the player(s) responsible for such conduct.

42.1.1 If it is possible to identify the player(s) responsible:

- a) Change the ball forthwith. The batter at the wicket shall choose the replacement ball from a selection of six other balls of various degrees of usage (including a new ball) and of the same brand as the ball in use prior to the contravention.
Additionally the bowler's end umpire shall:
 - b) Award 5 penalty runs to the batting side.
 - c) Inform the captain of the fielding side of the reason for the action taken.
 - d) Inform the captain of the batting side as soon as practicable of what has occurred.

- e) Together with the other umpire report the incident to the ICC Match Referee who shall take action as is appropriate against the player(s) responsible for the conduct under the ICC Code of Conduct. If the ICC Match Referee is unable to identify the player(s) responsible for such conduct, the captain shall take responsibility and will be subject to such action as is appropriate under the ICC Code of Conduct.
- 42.1.2 If it is not possible to identify the player(s) responsible:
- a) Change the ball forthwith. The umpires shall choose the replacement ball for one of similar wear and of the same brand as the ball in use prior to the contravention.
 - b) The bowler's end umpire shall issue the captain with a first and final warning, and
 - c) Advise him that should there be any further incident by that team during the remainder of the match or series, steps 42.1.1 a) to e) above will be adopted, with the captain deemed under e) to be the player responsible.

42.2 Law 42.4 - Deliberate attempt to distract striker

Law 42.4 shall apply subject to the following:

In addition, the umpires shall report the incident to the ICC Match Referee under the ICC Code of Conduct.

42.3 Law 42.5 - Deliberate distraction or obstruction of batter

Law 42.5 shall apply subject to the following:

In addition, the umpire shall report the incident to the ICC Match Referee under the ICC Code of Conduct.

42.4 Law 42.6 - Dangerous and Unfair Bowling

42.4.1 Law 42.6 (a) - The Bowling of Fast Short Pitched Balls

Law 42.6 (a) shall be replaced by the following:

- a) A bowler shall be limited to one fast short-pitched delivery per over.
- b) A fast short-pitched delivery is defined as a ball which passes or would have passed above the shoulder height of the striker standing upright at the crease.
- c) The umpire at the bowler's end shall advise the bowler and the batter on strike when each fast short pitched delivery has been bowled.
- d) In addition, for the purpose of this regulation and subject to Clause 42.4.1 (f) below, a ball that passes above head height of the batter, that prevents her from being able to hit it with her bat by means of a normal cricket stroke shall be called a wide.
- e) For the avoidance of doubt any fast short pitched delivery that is called a wide under this playing condition shall also count as the allowable short pitched delivery in that over
- f) In the event of a bowler bowling more than one fast short-pitched delivery in an over as defined in Clause 42.4.1 (b) above, the umpire at the bowler's end shall call and signal no ball on each occasion. A differential signal shall be used to signify a fast short pitched delivery. The umpire shall call and signal 'no ball' and then tap the head with the other hand.

- g) If a bowler delivers a second fast short pitched ball in an over, the umpire, after the call of no ball and when the ball is dead, shall caution the bowler, inform the other umpire, the captain of the fielding side and the batsmen at the wicket of what has occurred. This caution shall apply throughout the innings.
- h) If there is a second instance of the bowler being no balled in the innings for bowling more than one fast short pitched delivery in an over, the umpire shall advise the bowler that this is her final warning for the innings.
- i) Should there be any further instance by the same bowler in that innings, the umpire shall call and signal no ball and when the ball is dead direct the captain to take the bowler off forthwith. If necessary, the over shall be completed by another bowler, who shall neither have bowled the previous over, or part thereof, nor be allowed to bowl the next over, or part thereof.
- j) The bowler thus taken off shall not be allowed to bowl again in that innings.
- k) The umpire will report the occurrence to the other umpire, the batters at the wicket and as soon as possible to the captain of the batting side.
- l) The umpires will then report the matter to the ICC Match Referee who shall take such action as is considered appropriate against the captain and the bowler concerned. (Refer also to Law 42.1 Fair and Unfair Play - Responsibility of the Captains.)

The above is not a substitute for Clause 42.5 below which umpires are able to apply at any time.

42.4.2 Law 42.6 (b) Bowling of High Full Pitched Balls

Law 42.6 (b) shall be replaced by the following:

- a) Any delivery, which passes or would have passed on the full above waist height of the striker standing upright at the crease is deemed unfair, whether or not it is likely to inflict physical injury on the striker.
- b) In the event of a bowler bowling a high full pitched ball as defined in Clause 42.4.2 (a) above, the umpire at the bowler's end shall call and signal no ball.

If, in the opinion of the umpire, such a delivery is considered likely to inflict physical injury on the batter, the umpire at the bowler's end shall, in addition to calling and signalling no ball, when the ball is dead, caution the bowler and issue a first and final warning. The umpire shall inform the other umpire, the captain of the fielding side and the batter at the wicket of what has occurred.
- c) Should there be any further instance (where a high full pitched ball is bowled and is considered likely to inflict physical injury on the batter) by the same bowler in that innings, the umpire shall, in addition to calling and signalling no ball, when the ball is dead, direct the captain to take the bowler off forthwith. If necessary, the over shall be completed by another bowler, who shall neither have bowled the previous over, or part thereof, nor be allowed to bowl the next over, or part thereof.
- d) The bowler thus taken off shall not be allowed to bowl again in that innings.

- e) The umpire will report the occurrence to the other umpire, the batter at the wicket and as soon as possible to the captain of the batting side.
- f) The umpires will then report the matter to the ICC Match Referee who shall take such action as is considered appropriate against the captain and the bowler concerned. (Refer also to Law 42.1 Fair and Unfair Play - Responsibility of the Captains.)

42.5 Law 42.7 - Dangerous and Unfair Bowling - Action by the umpire

Law 42.7 shall be replaced by the following:

Regardless of any action taken by the umpire as a result of a breach of Clauses 42.4.1, 42.4.2 and 42.6 the following shall apply at any time during the match:

- 42.5.1 The bowling of fast short pitched balls is unfair if in the opinion of the umpire at the bowler's end he considers that by their repetition and taking into account their length, height and direction, they are likely to inflict physical injury on the striker, irrespective of the protective clothing and equipment he may be wearing. The relative skill of the striker shall also be taken into consideration.
- 42.5.2 In the event of such unfair bowling, the umpire at the bowler's end shall adopt the following procedure:
 - a) In the first instance the umpire shall call and signal no ball, caution the bowler and inform the other umpire, the captain of the fielding side and the batters of what has occurred.
 - b) If this caution is ineffective, he shall repeat the above procedure and indicate to the bowler that this is a final warning.
 - c) Both the above caution and final warning shall continue to apply even though the bowler may later change ends.
 - d) Should there be any further instance by the same bowler in that innings, the umpire shall call and signal no ball and when the ball is dead direct the captain to take the bowler off forthwith. If necessary, the over shall be completed by another bowler, who shall neither have bowled the previous over, or part thereof, nor be allowed to bowl the next over, or part thereof. See Law 22.8. (Bowler Incapacitated or Suspended during an Over).
 - e) The bowler thus taken off shall not be able to bowl again in that innings.
 - f) The umpire will report the occurrence to the other umpire, the batters at the wicket and as soon as possible to the captain of the batting side.
 - g) The umpires will then report the matter to the ICC Match Referee who shall take such action as is considered appropriate against the captain and the bowler concerned. (Refer also to Law 42.1 Fair and Unfair Play - Responsibility of the Captains.)

42.6 Law 42.8 - Deliberate bowling of High Full Pitched Balls

Law 42.8 shall be replaced by the following:

If the umpire considers that a high full pitch delivery which is deemed unfair as defined in Clause 42.4.2 was deliberately bowled, then the caution and warning process shall be dispensed with.

The umpire at the bowler's end shall:

- 42.6.1 Call and signal no ball.
- 42.6.2 When the ball is dead, direct the captain to take the bowler off forthwith.
- 42.6.3 Not allow the bowler to bowl again in that innings.
- 42.6.4 Ensure that the over is completed by another bowler, provided that the bowler does not bowl two overs or part thereof consecutively.
- 42.6.5 Report the occurrence to the other umpire, to the captain of the batting side and the ICC Match Referee who shall take such action as is considered appropriate against the captain and the bowler concerned. (Refer also to Law 42.1 Fair and Unfair Play Responsibility of the Captains).

42.7 Action by the umpires for dangerous and unfair Bowling

Should the umpires initiate the caution and warning procedures set out in Clauses 42.4.1, 42.4.2, 42.5 and 42.6 such cautions and warnings are not to be cumulative.

42.8 Law 42.9 - Time Wasting by the Fielding Side

Law 42.9 shall apply subject to Law 42.9 (c) being replaced by the following:

If there is any further waste of time in that innings, by any member of the fielding side the umpire shall:

- a) Call and signal dead ball if necessary, and;
- b) Award 5 penalty runs to the batting side (see Law 42.17).
- c) Inform the other umpire, the batters at the wicket and as soon as possible the captain of the batting side of what has occurred.
- d) Report the occurrence to the ICC Match Referee who shall take such action as is considered appropriate against the captain and the team concerned under the ICC Code of Conduct.

42.9 Law 42.10 - Batter Wasting Time

Law 42.10 shall apply, subject to the following:

In addition, the umpires will report the incident to the ICC Match Referee under the ICC Code of Conduct.

42.10 Law 42.14 Batter damaging the pitch

Law 42.14 shall apply, subject to the following:

See also clause 37 above.

42.11 Law 42.15 – Bowler attempting to run out non-striker before delivery

Law 42.15 shall be replaced by the following:

The bowler is permitted, before releasing the ball and provided she has not completed his usual delivery swing, to attempt to run out the non-striker. Whether the attempt is successful or not, the ball shall not count as one of the over. If the bowler fails in an attempt to run out the non-striker, the umpire shall call and signal Dead ball as soon possible.

42.12 Use of Electronic Communications Equipment

The use of electronic communication devices and equipment of any kind to communicate with players on the field of play shall not be permitted, except that broadcaster to player communication shall, with the prior consent of the participating countries, be allowed.

APPENDIX 1

All penalty runs in the Laws of Cricket (2000 Code 5th Edition - 2013) now apply in International Cricket. Some penalty runs can be referred to the ICC Match Referee for further action if necessary.

APPENDIX 2A

Calculation sheet for use when delays or interruptions occur in First Innings

Time

Net playing time available at start of the match	150 minutes	(A)
Time innings in progress	_____	(B)
Playing time lost	_____	(C)
Extra time available	_____	(D)
Time made up from reduced interval	_____	(E)
Effective playing time lost $[C - (D + E)]$	_____	(F)
Remaining playing time available $(A - F)$	_____	(G)
G divided by 3.8 (to 2 decimal places)	_____	(H)
Max overs per team $[H/2]$ (round up fractions)	_____	(I)
Maximum overs per bowler $[I / 5]$	_____	
Number of Powerplay Overs	_____ + _____	

Rescheduled Playing Hours

First session to commence or recommence	_____	(J)
Length of innings $[I \times 3.8]$	_____	(K)
Rescheduled first innings cessation time $[(J + K) - B]$	_____	(L)
Length of interval	_____	(M)
Second innings commencement time $(L + M)$	_____	(N)
Rescheduled second innings cessation time $(N + K)$	_____	(O)

* Ensure that the match is not finishing earlier than the original or rescheduled cessation time by applying clause 12.4.2 a) iv). If so, add at least one over to each team and recalculate (I) to (O) above to prevent this from happening.

APPENDIX 2B

Calculation sheet to check whether an interruption during the First Innings should terminate the innings

Proposed re-start time	_____	(P)
Rescheduled cut-off time allowing for full use of any extra time provision	_____	(Q)
Minutes between P and Q	_____	(R)
Potential overs to be bowled $[R / 3.8]$ (round up fractions)	_____	(S)
Number of complete overs faced to date in first innings	_____	(T)

If S is greater than T then revert to Appendix 2A

If S is less than or equal to T then the first innings is terminated and go to Appendix 3A

APPENDIX 3A**Calculation sheet for the start of the Second Innings****Maximum overs to be bowled:**

(If first innings was terminated, S from Appendix 2B) _____ (A)

Scheduled length of innings: $[A \times 3.8]$ _____ (B)

Start time _____ (C)

Scheduled cessation time $[C + B]$ _____ (D)**Overs per bowler and Fielding Restrictions**Maximum overs per bowler $[A / 5]$ _____ overs

Duration of Powerplay overs _____ + _____

APPENDIX 3B**Calculation sheet for use when interruption occurs after the start of the Second Innings****Time**

Time at start of innings _____ (A)

Time at start of interruption _____ (B)

Time innings in progress _____ (C)

Restart time _____ (D)

Length of interruption $[D - B]$ _____ (E)

Additional time available: (Any unused provision for 'Extra Time' or for earlier than scheduled start of second innings) _____ (F)

Total playing time lost $[E - F]$ _____ (G)**Overs**

Maximum overs at start of innings _____ (H)

Overs lost $[F / 3.8]$ (rounded down) _____ (I)Adjusted maximum length of innings $[H - I]$ _____ (J)Rescheduled length of innings $[J \times 3.8]$ _____ (K)Amended cessation time of innings $[D + (K - C)]$ _____ (L)**Overs per bowler and Fielding Restrictions**Maximum overs per bowler $[J / 5]$ _____ overs

Number of Powerplay overs _____ + _____

APPENDIX 4 - CREASE MARKINGS

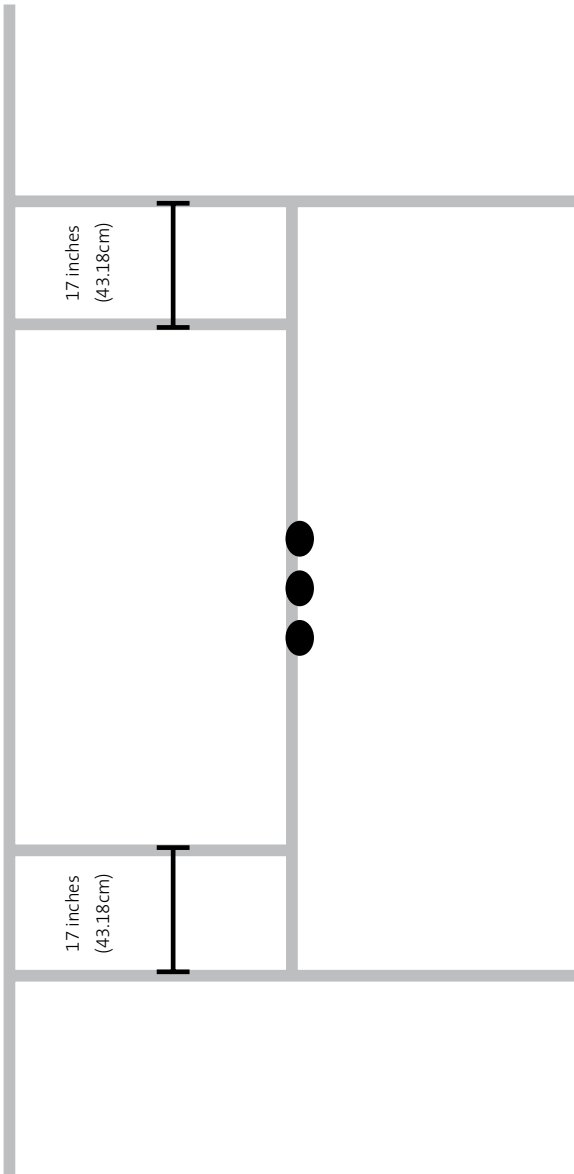

APPENDIX 5

Restriction of the placement of fielders

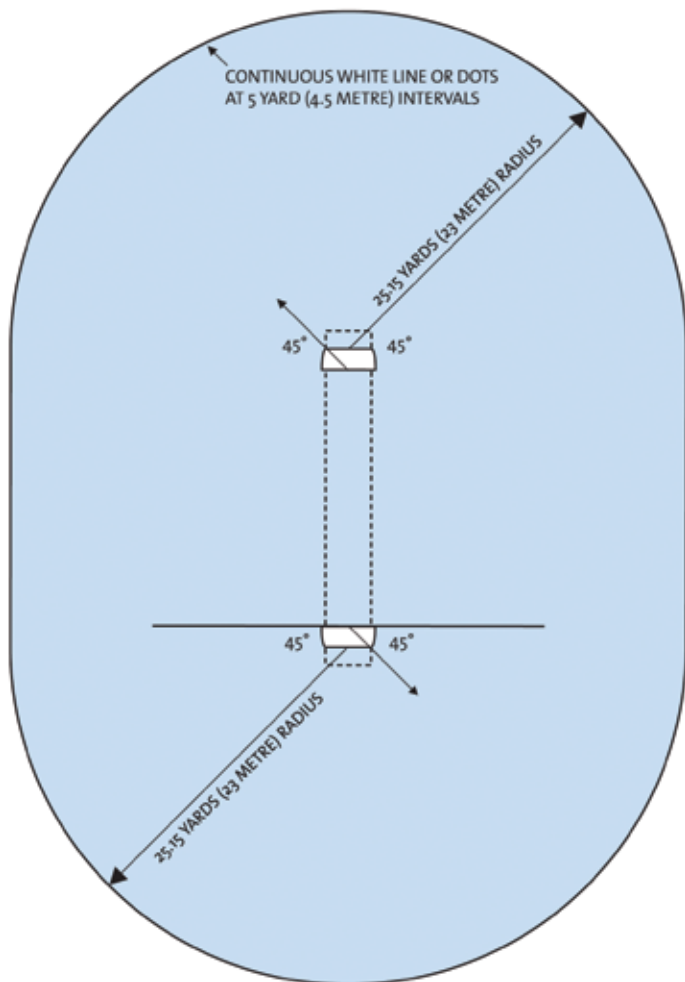

APPENDIX 6**Third Umpire TV Replay System – Playing Conditions****1 GENERAL**

- a) The Home Board shall endeavour to broadcast all Twenty20 matches played in its country.
- b) Where matches are broadcast the camera specifications set out in Appendix 6A shall be mandatory as a minimum requirement.
- c) Where matches are not broadcast, countries are encouraged to implement the camera specifications, as set out in Appendix 6B.
- d) For televised matches, the Home Board will ensure a separate room is provided for the third umpire and that he has access to a television monitor and direct sound link with the television control unit director to facilitate as many replays as is necessary to assist him in making a decision.
- e) For televised matches and in the circumstances detailed in Clauses 2, 4 and 5 below, the on-field umpire has the discretion whether or not to refer the appeal to the third umpire or, in the case of paragraph 3, 5 and 6 to consult with the third umpire before making his decision and should take a common sense approach. Players may not appeal to the umpire to use the replay system - breach of this provision would constitute dissent and the player could be liable for discipline under the ICC Code of Conduct.
- f) For televised matches, the third umpire shall call for as many replays from any camera angle as is necessary to reach a decision. As a guide, a decision should be made within 30 seconds whenever possible, but the third umpire shall have discretion to take more time in order to finalise a decision.
- g) The third umpire shall only have access to TV replays for the provisions of paragraphs 2, 3, 4, 5 and 6 below. Other technology which may be in use by the broadcaster for broadcast purposes (Hot Spot, ball tracking, Snicko) shall not be permitted.

2 RUN OUT, STUMPING AND HIT WICKET DECISIONS

- 2.1 For televised matches, the on-field umpire shall be entitled to refer an appeal for a run-out, stumping or hit-wicket to the third umpire.
- 2.2 For televised matches, an on-field umpire wishing to refer a decision to the third umpire shall signal to the third umpire by making the shape of a TV screen with his hands.
- 2.3 For televised matches, if the third umpire decides the batter is out a red light is displayed; a green light means not-out. Should the third umpire be temporarily unable to respond, a white light (where available) will remain illuminated throughout the period of interruption to signify to the on-field umpires that the TV replay system is temporarily unavailable, in which case the decision will be taken by the on-field umpire. (Where available and as an alternative to the red/green light system, the big replay screen may be used for the purpose of conveying the third umpire's decision).
- 2.4 For televised matches, when reviewing the TV replay(s), the third umpire shall first check the fairness of the delivery (foot fault, bowler breaking the wicket, waist high full tosses, bouncers above shoulder height). Additionally, if the third umpire finds the batter is out by another mode of dismissal (excluding LBW), or not out by any mode of dismissal (excluding LBW), he shall notify the on-field umpire so that the correct decision is made.
- 2.5 Zing Wickets are permitted to be used for run-out, stumping and hit wicket decisions (using the lights to determine if the wicket is broken)

3 CAUGHT DECISIONS

For televised matches, the on-field umpire shall be entitled to refer an appeal for a caught decision to the third umpire in the following circumstances:

3.1 Clean catches

- a) Should the bowler's end umpire be unable to decide whether or not a catch was taken cleanly, he shall first consult with the square leg umpire.
- b) Should both umpires be unable to make a decision, they may consult by two-way radio with the 3rd umpire. Following such consultation, the final decision will be made and given by the bowler's end umpire, who will take into account the on-field umpires' initial views and any other advice received from the 3rd umpire.
- c) The third umpire has to determine whether the batter has been caught. However, when reviewing the television replay(s), the third umpire shall first check the fairness of the delivery (foot fault, bowler breaking the wicket, waist high full tosses, bouncers above shoulder height). Additionally, if it is clear to the third umpire that the batter is out by another mode of dismissal (excluding LBW), or not out by any mode of dismissal (excluding LBW), he shall notify the on-field umpire so that the correct decision is made.

3.2 Bump Ball

- a) Should the bowler's end umpire be unable to decide whether a catch was taken from a bump ball or not, he shall first consult with the square leg umpire.
- b) Should both on-field umpires be unable to make a decision, the bowler's end umpire shall be entitled to refer the decision to the third umpire to review a TV replay(s) of the batter's stroke as in Clause 3.2.2 (b).
- c) The third umpire has to determine whether the ball was a bump ball or not. However, when reviewing the television replay(s), the third umpire shall first check the fairness of the delivery (foot fault and bowler breaking the wicket). Additionally, if it is clear to the third umpire that the batter is out by another mode of dismissal (excluding LBW), or not out by any mode of dismissal (excluding LBW), he shall notify the on-field umpire so that the correct decision is made.
- d) The third umpire shall communicate his decision by the system as in Clause 3.2.2 (c).

4 BOUNDARY DECISIONS

- a) For televised matches, the on-field umpire shall be entitled to refer to the third umpire for a decision about whether the fielder had any part of her person in contact with the ball when she touched the boundary or when she had any part of her person grounded beyond the boundary or whether a four or six had been scored. A decision is to be made immediately and cannot be changed thereafter.
- b) For televised matches, an on-field umpire wishing the assistance of the third umpire in this circumstance shall communicate with the third umpire by use of a two-way radio and the third umpire will convey their decision to the on-field umpire by this method.

- c) For televised matches, the third umpire may initiate contact with the on-field umpire by two-way radio if TV coverage shows a boundary line infringement or incident that appears not to have been acted upon by the on-field umpires.

5 OBSTRUCTING THE FIELD

- a) Following an appeal from the fielding side, the on-field umpire shall be entitled to consult with the third umpire if he feels that the batter, in running between the wickets, may have significantly changed her direction (refer clause 37).
- b) Such consultation shall be initiated by the on-field umpire and will be done to help him decide the extent of any change in direction and whether the obstruction was wilful or not.
- c) Following such consultation with the third umpire, the final decision shall be indicated in the normal fashion by the relevant on-field umpire.

6 BATTER RUNNING TO THE SAME END

- 6.1 In the event of both batters running to the same end and the umpires are uncertain over which batter made his ground first, the on-field umpire may consult with the third umpire.
- 6.2 The procedure in paragraph 4.2 shall apply.

7 NO BALLS

If the on-field umpire is uncertain as the fairness of the delivery (foot-fault, bowler breaking the wicket, waist high full tosses, bouncers above shoulder height only), he shall be entitled to request the batter to delay leaving the field and to check the fairness of the delivery with the third umpire. Consultation with the third umpire shall be by way of two way radio. If the delivery was not a fair delivery the on-field umpire shall indicate that the batter is not-out and signal no-ball. for the avoidance of doubt, the third umpire shall apply clause 24.3 when deciding whether a no-ball should have been called.

APPENDIX 6A

Generic Camera Layout - Basic TV Coverage

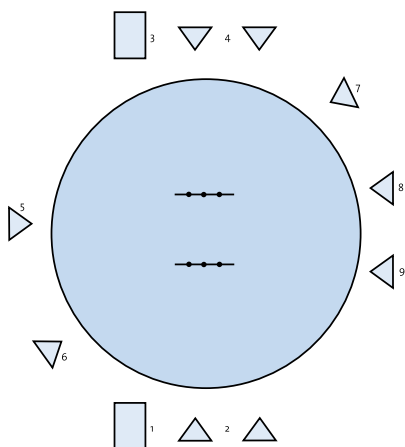

- 1 Wicket to Wicket
- 2 Follow
- 3 Wicket to Wicket
- 4 Follow
- 5 Square Leg/Mid Wicket
- 6 Slips
- 7 Slips
- 8 Line / Run out Cam
- 9 Line / Run out Cam

APPENDIX 6B

Generic Camera Layout - Third Umpire Coverage

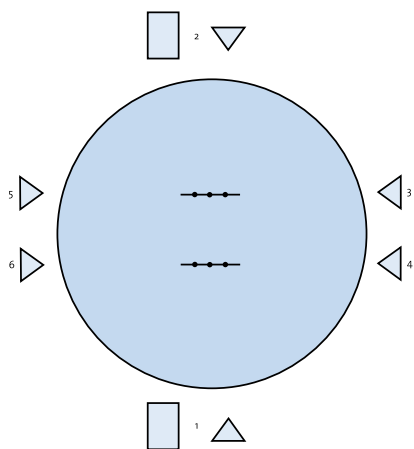

- 1 Follow
- 2 Follow
- 3 Line / Run out Cam
- 4 Line / Run out Cam
- 5 Line / Run out Cam
- 6 Line / Run out Cam

APPENDIX 7**Procedure for the Super Over**

- 1 Subject to weather conditions the Super Over will take place on the scheduled day of the match at a time to be determined by the ICC Match Referee (or umpires if there is no match referee present and on duty at the ground). In normal circumstances it shall commence 10 minutes after the conclusion of the match.
- 2 The amount of extra time allocated to the Super Over is the greater of (a) the extra time allocated to the original match less the amount of extra time actually utilised and (b) the gap between the actual end of the match and the time the original match would have been scheduled to finish had the whole of the extra time provision been utilised. Should play be delayed prior to or during the Super Over, once the playing time lost exceeds the extra time allocated, the Super Over shall be abandoned. See clause 15.
- 3 The Super Over will take place on the pitch allocated for the match (the designated pitch) unless otherwise determined by the umpires in consultation with the ground authority and the ICC Match Referee or umpires.
- 4 The umpires shall stand at the same end as that in which they finished the match.
- 5 In both innings of the Super Over, the fielding side shall choose from which end to bowl.
- 6 Only nominated players in the main match may participate in the Super Over. Should any player (including the batsmen and bowler) be unable to continue to participate in the Super Over due to injury, illness or other wholly acceptable reasons, the relevant Laws and Playing Conditions as they apply in the main match shall also apply in the Super Over.
- 7 Any penance time being served in the main match shall be carried forward to the Super Over.
- 8 Each team's over is played with the same fielding restrictions as apply for the last over in a normal T20 International match.
- 9 The team batting second in the match will bat first in the Super Over.
- 10 The fielding captain or his nominee shall select the ball with which he wishes to bowl his over in the Super Over from the box of spare balls provided by the umpires. Such box to include the balls used in the main match, but no new balls. The team fielding first in the Super Over shall have first choice of ball. The team fielding second may choose to use the same ball as chosen by the team bowling first. If the ball needs to be changed, then playing conditions as stated for the main match shall apply.
- 11 The loss of two wickets in the over ends the team's one over innings.
- 12 In the event of the teams having the same score after the Super Over has been completed, if the original match was a tie under the D/L method, clause 14 immediately applies. Otherwise, the team whose batters hit the most number of boundaries combined from its two innings in both the main match and the Super Over shall be the winner.
- 13 If the number of boundaries hit by both teams is equal, the team whose batsmen scored more boundaries during its innings in the main match (ignoring the Super Over) shall be the winner.

- 14 If still equal, a count-back from the final ball of the Super Over shall be conducted. The team with the higher scoring delivery shall be the winner. If a team loses two wickets during its over, then any unbowled deliveries will be counted as dot balls. Note that for this purpose, the runs scored from a delivery is defined as the total team runs scored since the completion of the previous legitimate ball, i.e including any runs resulting from wides, no ball or penalty runs.

Example:

SCORED FROM:	TEAM 1	TEAM 2
Ball 6	1	1
Ball 5	4	4
Ball 4	2	1
Ball 3	6	2
Ball 2	0	1
Ball 1	2	6

In this example both teams scored an equal number of runs from the 6th and 5th ball of their innings. However team 1 scored 2 runs from its 4th ball while team 2 scored a single so team 1 is the winner.

- 14 Clause 2 examples:

Scheduled finish 5.00, 30 minutes extra time available, so scheduled finish time if the whole of the extra time provision is utilised is 5.30.

- No extra time is utilised in the original match which overruns ten minutes and finishes at 5.10. The Super Over is scheduled to start at 5.20 with 30 minutes extra time available. It starts on time but is interrupted at 5.25. Play must resume by 5.55 otherwise the Super Over is abandoned.
- 20 minutes of extra time was utilised, with the match scheduled to finish at 5.20, but it actually finishes at 5.10. Therefore the extra time allocated to the Super Over is the greater of a) 10 minutes (30 minutes extra time less 20 already utilised) and b) 20 minutes (the gap from the actual finish time of 5.10 and the scheduled finish had the full extra time been utilised of 5.30). The Super Over was due to start at 5.20, but is delayed by rain. It must therefore start by 5.40 or the Super Over is abandoned.
- The match finishes at 5.40 (having started 30 minutes late and overrun by 10 minutes). There is no extra time allocated to the Super Over which should start at 5.50. Any delay or interruption after 5.50 means the Super Over is abandoned.

PEPSI ICC **WORLD CRICKET LEAGUE**
STANDARD PLAYING CONDITIONS

PEPSI ICC WORLD CRICKET LEAGUE

STANDARD PLAYING CONDITIONS

Except as varied hereunder the Laws of Cricket (2000 Code 5th Edition - 2013) shall apply.

Note: All references to 'Governing Body' within the Laws of Cricket shall be replaced by 'ICC Tournament Referee'.

1 LAW 1 - THE PLAYERS

1.1 Law 1.1 - Number of Players

Law 1.1 shall be replaced by the following:

- 1.1.1 A match is played between two sides. Each side shall consist of a maximum of 11 players, one of whom shall be captain.
- 1.1.2 If a team has less than 11 players available to play in a particular match it shall have the option to complete the match with the players who are available, provided that if it has less than 9 players it shall be obliged to forfeit the match.
- 1.1.3 Notwithstanding the above, in the example of any team's late arrival at an event for its first round match only, or if it has less than 9 players available to play in its first round match only, the Event Technical Committee shall make every effort to re-schedule its first round match during one of the two allocated rest/reserve days. Refer 12.1.6
- 1.1.4 A team that is unable to field a minimum of 9 players in any match after the first round shall be obliged to forfeit the match.
- 1.1.5 If a team forfeits its first two matches in any event, for whatever reasons, it shall immediately be withdrawn from the event.

1.2 Law 1.2 - Nomination of Players

Law 1.2 shall be replaced by the following:

- 1.2.1 Each captain shall nominate 11 players plus a maximum of 3 substitute fielders (or less subject to the provisions of 1.1 above) in writing to the ICC Tournament Referee before the toss. No player (member of the playing eleven) may be changed after the nomination without the consent of the opposing captain.
- 1.2.2 Only those nominated as substitute fielders shall be entitled to act as substitute fielders during the match, unless the ICC Tournament Referee, in exceptional circumstances, allows subsequent additions.
- 1.2.3 All those nominated including those nominated as substitute fielders, must be eligible to play for that particular team in the tournament and part of the team's official playing squad.
- 1.2.4 In addition, by their nomination, the nominees shall be deemed to have agreed to abide by all the applicable ICC Regulations pertaining to international cricket and in particular, the Clothing and Equipment Regulations, the Code of Conduct for Players and Player Support Personnel (hereafter referred to as the ICC Code of Conduct), the Anti-Racism Code for Players and Player Support Personnel, the Anti-Doping Code and the Anti-Corruption Code.

1.3 Law 1.3 – Captain

The following shall apply in addition to Law 1.3 (a):

The deputy must be one of the 11 nominated players.

Each member Board must nominate its 'Team Captain' to the ICC when appointed.

If the 'Team Captain' is not participating in a series, the relevant Home Board must nominate a replacement 'Team Captain' for the series. The home Board shall advise the series match referee.

If the 'Team Captain' plays in a match without being the nominated captain for that match, he will be deemed to be the captain should any penalties be applied for over rate breaches under the Code of Conduct.

2 LAW 2 - SUBSTITUTES AND RUNNERS, BATSMAN OR FIELDER LEAVING THE FIELD, BATSMAN RETIRING, BATSMAN COMMENCING INNINGS

Law 2 shall apply subject to the following:

2.1 Law 2.1 Substitutes and Runners

Law 2.1 (a) (ii), 2.7 and 2.8 shall not apply. A runner for a batsman when batting is not permitted.

Law 2.1 (b) shall be amended as follows:

The umpires shall have discretion to allow, for other wholly acceptable reasons, a substitute fielder to act for a nominated player at the start of the match, or at any subsequent time.

2.2 Law 2.5 - Fielder Absent or Leaving the Field

Law 2.5 shall be replaced by the following:

If a fielder fails to take the field with his side at the start of the match or at any later time, or leaves the field during a session of play, the umpire shall be informed of the reason for his absence, and he shall not thereafter come on to the field during a session of play without the consent of the umpire. (See Law 2.6 as modified). The umpire shall give such consent as soon as practicable.

If the player is absent from the field for longer than 8 minutes:

2.2.1 the player shall not be permitted to bowl in that innings after his return until he has been on the field for at least that length of playing time for which he was absent.

2.2.2 the player shall not be permitted to bat unless or until, in the aggregate, he has returned to the field and/or his side's innings has been in progress for at least that length of playing time for which he has been absent or, if earlier, when his side has lost five wickets.

The restriction in Clauses 2.2.1 and 2.2.2 above shall not apply if the player has suffered an external blow (as opposed to an internal injury such as a pulled muscle) whilst participating earlier in the match and consequently been forced to leave the field. Nor shall it apply if the player has been absent for very exceptional and wholly acceptable reasons (other than injury or illness).

In the event of a batsman or a fieldsman already being off the field at the commencement of an interruption in play through ground, weather or light conditions or for other exceptional circumstances, he shall be allowed to count any such stoppage time as playing time, provided that he personally informs the umpires when he is fit enough to take the field had play been in progress. Similarly, if

at the commencement of an interruption in play through ground, weather or light conditions or for other exceptional circumstances, a player is on the field but still has some unexpired penalty time remaining from a previous absence, he shall automatically be allowed to count any such stoppage time as playing time.

- 2.2.3 Substitute fielders shall only be permitted in cases of injury, illness or other wholly acceptable reasons. 'Wholly acceptable reasons' should be limited to extreme circumstances and should not include what is commonly referred to as a 'comfort break'.

Note: Squad members of the fielding team who are not playing in the match and who are not acting as substitute fielders shall be required to wear a team training bib whilst on the playing area (including the area between the boundary and the perimeter fencing).

3 LAW 3 - THE UMPIRES

3.1 Law 3.1 - Appointment and Attendance

Law 3.1 shall be replaced by the following:

- 3.1.1 ICC will appoint the on-field umpires.
- 3.1.2 Neither team will have a right of objection to an umpire's appointment.
- 3.1.3 The umpires shall be present at the ground at least one hour before the scheduled start of play.
- 3.1.4 ICC shall appoint a Tournament Referee who shall remain contactable throughout.

3.2 Third Umpires / TV Replays

The TV replay referral system shall not apply.

3.3 Law 3.2 - Change of Umpire

The following shall apply in place of Law 3.2:

- 3.3.1 An umpire shall not be changed during the match, other than in exceptional circumstances, such as injury or illness.

3.4 Law 3.4 - To Inform Captains and Scorers

In addition to Law 3.4 (i)

The event organisers may provide for the ringing of a bell, which shall be rung 5 minutes before the termination of an interval, when the umpires shall go to the wickets. The event organisers shall inform the participants at the start of the event that this practice is to be adopted.

3.5 Law 3.8 - Fitness of Ground, Weather and Light and

Law 3.9 - Suspension of Play for Adverse Conditions of Ground, Weather or Light

Laws 3.8 and 3.9 shall apply subject to the following:

- 3.5.1 The safety of all persons within the ground is of paramount importance to the ICC. In the event that any threatening circumstance, whether actual or perceived, comes to the attention of any umpire (including for example weather, pitch invasions, act of God, etc. See also 3.6), then the players and officials should immediately be asked to leave the field of play in a safe and orderly manner and to relocate to a secure and safe area (depending on each particular threat) pending the satisfactory passing or resolution of such threat or risk to the reasonable satisfaction of

the umpires, ICC Tournament Referee, the head of the relevant ground authority, the head of ground security and/or the police as the circumstances may require. See also clause 3.6 below.

Laws 3.8 & 3.9 shall be replaced by:

3.5.2 The umpires shall be the final judges of the fitness of the ground, weather and light for play. See 3.5.3 below and Law 7.2 (Fitness of the pitch for play).

3.5.3 Suspension of play for adverse conditions of ground, weather or light

- a) All references to ground include the pitch.
See Law 7.1 (Area of pitch).
- b) If at any time the umpires together agree that the conditions of ground, weather or light are so bad that there is obvious and foreseeable risk to the safety of any player or umpire, so that it would be unreasonable or dangerous for play to take place, then they shall immediately suspend play, or not allow play to commence or to restart. The decision as to whether conditions are so bad as to warrant such action is one for the umpires alone to make.

The fact that the grass and the ball are wet and slippery does not warrant the ground conditions being regarded as unreasonable or dangerous. If the umpires consider the ground is so wet or slippery as to deprive the bowler of a reasonable foothold, the fielders of the power of free movement, or the batsmen of the ability to play their strokes or to run between the wickets, then these conditions shall be regarded as so bad that it would be unreasonable for play to take place.

The Umpires shall disregard any shadow on the pitch from the stadium or from any permanent object on the ground.

- c) When there is a suspension of play it is the responsibility of the umpires to monitor the conditions. They shall make inspections as often as appropriate. Immediately the umpires together agree that conditions are suitable for play they shall call upon the players to resume the game.
 - d) If play is in progress up to the start of an agreed interval then it will resume after the interval unless the umpires together agree that the conditions of ground, weather or light are so bad that there is obvious and foreseeable risk to the safety of any player or umpire, so that it would be unreasonable or dangerous for play to take place.
- 3.5.4 Play may be suspended due to safety and security concerns by the umpires on the advice of the ICC Tournament Referee, the head of the relevant ground authority, the head of ground security or the police.
- 3.5.5 Where play is suspended under Clause 3.5.4 above the decision to abandon or resume play shall be the responsibility of the ICC Tournament Referee who shall act only after consultation with the head of ground security and the police.

3.6 Light Meters

Light Meters will not be used.

3.7 Use of Lights

Artificial lights shall not be used.

3.8 Clothing and Equipment

- 3.8.1 All matches shall be day matches
- 3.8.2 Pads and players' and umpires' clothing shall be coloured in all matches and shall comply with the provisions and specifications contained in the Members Participation Agreement (MPA) signed by the competing teams.
- 3.8.3 Sight screens will be black.

3.9 Advertising on grounds

3.9.1 Advertising on grounds

The logos on outfielders are to be positioned as follows:

- a) Behind the stumps – a minimum of 25.15 yards (23 meters) from the stumps.
- b) Midwicket/cover area – no advertising to be positioned within the 30 yard (27.50 meters) circle.

Note: Advertising closer to the stumps as set out above which is required to meet 3D requirements for broadcasters may be permitted, subject to prior ICC approval having been obtained.

3.9.2 Perimeter Boards

- a) Advertising on perimeter boards placed in front of the sightscreens is permitted save that the predominant colour of such advertising shall be of a contrasting colour to that of the ball.
- b) Advertising on perimeter boards behind the stumps at both ends shall not contain moving, flashing or flickering images and operators should ensure that the images are only changed or moved at a time that will not be distracting to the players or the umpires.
- c) In addition, the brightness of any electronic images shall be set at a level so that it is not a distraction to the players or umpires.

3.9.3 Sightscreens

- a) Sightscreens shall be provided at both ends of all grounds.
- b) Advertising shall be permitted on the sightscreen behind the striker, providing it is removed for the subsequent over from that end.
- c) Such advertising shall not contain flashing or flickering images and particular care should be taken by the operators that the advertising is not changed at a time which is distracting to the umpire.

4 LAW 4 - THE SCORERS

4.1 Law 4.2 - Correctness of Scores

Attention is drawn to Clause 21.

5 LAW 5 - THE BALL

5.1 Law 5.2 - Approval and Control of Balls

Law 5.2 shall be replaced by the following:

White cricket balls supplied by ICC will be used for all matches. Spare used balls for changing during a match, which shall also be of the same brand shall be provided.

The fielding captain or his nominee may select the ball with which he wishes to bowl from the supply provided by the event organisers. The third umpire or an on-field umpire shall take a box containing at least 3 new balls to the dressing room and supervise the selection of the balls.

The umpires shall retain possession of the match ball(s) throughout the duration of the match when play is not actually taking place. During play umpires shall periodically and irregularly inspect the condition of the ball and shall retain possession of it at the fall of a wicket, a drinks interval, or any other disruption in play. Each fielding team shall have one new ball for its innings.

5.2 Law 5.4 - New Ball in Match of More than One Day's Duration

Law 5.4 shall not apply.

5.3 Law 5.5 - Ball Lost or Becoming Unfit for Play

Law 5.5 shall be replaced by the following:

In the event of a ball during play being lost or in the opinion of the umpires, being unfit for play through normal use, the umpires shall allow it to be replaced by one that in their opinion has had a similar amount of wear.

In the event of the ball becoming wet and soggy as a result of play continuing in inclement weather or it being affected by dew, or a white ball becoming significantly discoloured and in the opinion of the umpires being unfit for play, the ball may be replaced for a ball that has similar amount of wear, even though it has not gone out of shape.

If the ball is to be replaced, the umpire shall inform the batsman. Either batsman or bowler may raise the matter with the umpires and the umpires' decision as to a replacement or otherwise will be final.

5.4 Law 5.6 - Specifications

Law 5.6 shall not apply.

6 LAW 6 - THE BAT

6.1 Law 6.1 - Width and Length

The following shall apply in addition to Law 6.1:

Subject to any moratoriums that may be in place only Grade A bats shall be used.

7 LAW 7 - THE PITCH

7.1 Law 7.3 - Selection and Preparation

The following will apply in addition to Law 7.3:

7.1.1 The ground staff shall ensure that during the period prior to the start of play and during intervals, the pitch area shall be secured as to prevent unauthorised access. (The pitch area shall include an area at least 2 metres beyond the rectangle made by the crease markings at both ends of the pitch).

- 7.1.2 The umpires shall ensure that, prior to the start of play and during any intervals, only authorised ground staff, the ICC match officials, players, team coaches and authorised television personnel shall be allowed access to the pitch area. Such access shall be subject to the following limitations:
- Only captains and team coaches may walk on the actual playing surface of the pitch area (outside of the crease markings).
 - No spiked footwear shall be permitted.
 - No one shall be permitted to bounce a ball on the pitch, strike it with a bat or cause damage to the pitch in any other way.
 - Access shall not interfere with pitch preparation.
- 7.1.3 In the event of any dispute, the ICC Tournament Referee will rule and his ruling will be final.

7.2 Law 7.4 - Changing the Pitch

Law 7.4 shall be replaced by the following:

- 7.2.1 In the event of a pitch being considered too dangerous for play to continue in the estimation of the on-field umpires, they shall stop play and immediately advise the ICC Tournament Referee.
- 7.2.2 The on-field umpires and/or ICC Tournament Referee shall consult with both captains.
- 7.2.3 If the captains agree to continue, play shall resume.
- 7.2.4 If the decision is not to resume play, the on-field umpires together with the ICC Tournament Referee and the Event Technical Committee shall consider whether the existing pitch can be repaired and the match resumed from the point it was stopped. In considering whether to authorise such repairs, the ICC Tournament Referee and the Event Technical Committee must consider whether this would place either side at an unfair advantage, given the play that had already taken place on the dangerous pitch.
- 7.2.5 If the decision is that the existing pitch cannot be repaired, then the match is to be abandoned with the following consequences:
- In the event of the required number of overs to constitute a match having been completed at the time the match is abandoned, the result shall be determined according to the provisions of clause 21.7.2.
 - In the event of the required number of overs to constitute a match not having been completed, the match will be abandoned as a no result.
- 7.2.6 If the match is abandoned as a no result, the ICC Tournament Referee and the Event Technical Committee shall consult with the objective of finding a way for a new match to be commenced and completed on the same date and venue.
- 7.2.7 Such a match may be played either on the repaired pitch or on another pitch, subject to the ICC Tournament Referee and the Event Technical Committee the relevant ground authority both being satisfied that the new pitch will be of the required standard. The playing time lost between the scheduled start time of the original match and the actual start time of the new match will be covered by the provisions of clauses 12 and 16.

- 7.2.8 If it is not possible to play a new match on the scheduled day of the original match the Event Technical Committee shall agree on whether the match can be replayed within the existing reserve days in accordance with clause 12.1.6.
- 7.2.9 Throughout the above decision making processes, the on-field umpires and/or ICC Tournament Referee shall keep informed both captains and the head of the ground authority. The head of the ground authority shall ensure that suitable and prompt public announcements are made.

7.3 Law 7.5 - Non-Turf Pitches

The following shall apply in addition to Law 7.5:

As a first preference, all matches shall be played on natural turf pitches. Where necessary matches can be rescheduled on non-turf pitches for any matches and/or reserve day, subject to compliance of Law 7.5.

8 LAW 8 - THE WICKETS

8.1 Law 8.2 - Size of Stumps

The following shall apply in addition to Law 8.2:

For televised matches the Home Board may provide a slightly larger cylindrical stump to accommodate the stump camera. When the larger stump is used, all three stumps must be exactly the same size.

8.2 Zing Wickets

For televised matches the use of Zing wickets is permitted.

9 LAW 9 - THE BOWLING, POPPING AND RETURN CREASES

9.1 Law 9.3 - The Popping Crease

Law 9.3 shall apply, except that the reference to 'a minimum of 6 ft' shall be replaced by 'a minimum of 15 yards (13.71m)'.

9.2 Additional Crease Markings

The following shall apply in addition to Law 9:

As a guideline to the umpires for the calling of wides on the offside the crease markings detailed in Appendix 2 shall be marked in white at each end of the pitch.

10 LAW 10 - PREPARATION AND MAINTENANCE OF THE PLAYING AREA

10.1 Law 10.1 - Rolling

The following shall apply in addition to Law 10.1:

- 10.1.1 Prior to tossing for choice of innings the artificial drying of the pitch and outfield shall be at the discretion of the groundsman. Thereafter and throughout the match the drying of the outfield may be undertaken at any time by the groundsman, but the drying of the affected area of the pitch shall be carried out only on the instructions and under the supervision of the umpires. The umpires shall be empowered to have the pitch dried without reference to the captains at any time they are of the opinion that it is unfit for play.

10.1.2 The umpires may instruct the groundsmen to use any available equipment, including any roller for the purpose of drying the pitch and making it fit for play.

10.1.3 An absorbent roller may be used to remove water from the covers including the cover on the match pitch.

10.2 Law 10.6 - Maintenance of Footholes

The following shall apply in addition to Law 10.6:

The umpires shall see that wherever possible and whenever it is considered necessary, action is taken during all intervals in play to do whatever is practicable to improve the bowler's foot holes.

10.3 Protection and preparation of adjacent pitches during matches

The protection (by way of an appropriate cover) and preparation of pitches which are adjacent to the match pitch will be permitted during the match subject to the following:

10.3.1 Such measures will only be possible if requested by the ground curator and approved by the umpires before the start of the match.

10.3.2 Approval should only be granted where such measures are unavoidable and will not compromise the safety of the players or their ability to execute their actions with complete freedom.

10.3.3 The preparation work shall be carried out under the supervision of the fourth umpire.

10.3.4 Any necessary watering shall be carried out only to the extent necessary for such preparations and shall not be permitted in circumstances which may in any way affect the match pitch.

10.3.5 The consent of the captains is not required but the umpires shall advise both captains and the ICC Tournament Referee before the start of the match on what has been agreed.

11 LAW 11 - COVERING THE PITCH

11.1 Law 11.1 - Before the Match

The following shall apply in addition to Law 11.1:

The pitch shall be entirely protected against rain up to commencement of play.

11.2 Law 11.2 - During the Match

Law 11.2 shall be replaced by the following:

The pitch shall be entirely protected against rain up to the re-commencement of play and for the duration of the period of the match.

The covers must totally protect the pitch and also the pitch surroundings, a minimum 5 metres either side of the pitch and any worn or soft areas in the outfield.

11.3 Law 11.3 - Covering Bowlers' Run Ups

Law 11.3 shall be replaced by the following:

Wherever possible and available the bowler's run-ups shall be covered to a distance of at least 5 x 5 metres.

11.4 Law 11.4 - Removal of Covers

Law 11.4 shall be replaced by the following:

The covers shall be removed no earlier than 5.00am and no later than 7.00am on the morning of the match (including the reserve day, if applicable), provided it is not raining at the time, but they will be replaced if rain falls prior to the commencement of play.

Attention is drawn to clauses 3.5 and 10.3 above.

12 LAW 12 - INNINGS

Law 12 shall apply subject to the following (see also clauses 15 and 16 below):

12.1 Law 12.1 - Number of Innings

Law 12.1 shall be replaced by the following:

- 12.1.1 All matches will consist of one innings per side, each innings being limited to a maximum of 50 overs.
- 12.1.2 All matches shall be of one day's scheduled duration.
- 12.1.3 Every effort will be made to complete matches on the scheduled day with any necessary reduction in overs taking place. Only if the minimum number of overs necessary to constitute a match cannot be bowled on the scheduled day will the match be deemed as abandoned.
- 12.1.4 Reserve days shall only be utilised for rescheduling of abandoned matches as deemed in 12.1.3.
- 12.1.5 For the preliminary group matches, where possible, reserve days shall be scheduled on which 'abandoned' matches shall be replayed in accordance with section 12.1.6 below.
- 12.1.6 Abandoned matches, as deemed in 12.1.3, shall be rescheduled to the reserve days as follows:
 - a) Individual abandoned matches (i.e. one or two matches from any incomplete round) will be given priority for rescheduling over any full round of abandoned matches (i.e. three matches). For the sake of clarity, one or two first round matches which need to be rescheduled in circumstances provided for in clause 1.1 shall be deemed to be abandoned matches for the purpose of this clause and they will be given priority for rescheduling over any full round of abandoned matches.
 - b) Individual abandoned matches will be rescheduled in order of either:
 - i) The scheduled round in which the most matches have been abandoned (i.e. a round with two abandoned matches will be prioritised over a round with one abandoned match),
then
 - ii) In order of the earliest scheduled round in the event of two or more rounds having an equal number of abandoned matches
 - c) Any full rounds of abandoned matches will be rescheduled (subject to 12.1.6 (a) above) in order of the earliest scheduled round

- 12.1.7 The ICC Event Technical Committee may, at their sole discretion, cancel the final and ranking play-offs, and utilise that day to reschedule matches in the following circumstances:
- Rescheduling of any individual abandoned matches which will have a bearing on the top four positions in the final league table on match points only
 - Rescheduling of any remaining full round of abandoned matches
- 12.1.8 There is no reserve day allocated for the finals and ranking play-off matches.
- 12.1.9 Subject to any of the previous points, if an abandoned match cannot be rescheduled on any reserve day, the match shall be declared as a no result and points will be awarded as provided for in 21.10.
- 12.1.10 In the event of any dispute the ICC Event Technical Committee may be called on to make a ruling and its ruling shall be final.
- 12.1.11 If less than (a specified number or rounds) are completed at tournament end the ICC Development Committee may use the completed results from this tournament, and its best discretion, to recommend to the Executive Board to decide which team(s) will progress from this tournament to future Pepsi ICC World Cricket League tournaments (i.e. it may not be the top ranked teams from the tournament).

12.2 Law 12.2 - Alternate Innings

Law 12.2 shall not apply.

12.3 Law 12.3 - Completed Innings

Laws 12.3 (c), (d) and (e) (iii) shall not apply.

12.4 Length of Innings

12.4.1 Uninterrupted Matches.

- Each team shall bat for 50 overs unless all out earlier.
- If the team fielding first fails to bowl the required number of overs by the scheduled time for cessation of the first innings, play shall continue until the required number of overs has been bowled. The interval shall be reduced to enable the second innings to commence at the scheduled time, subject to there being a minimum interval of 20 minutes. The team batting second shall receive its full quota of 50 overs irrespective of the number of overs it bowled in the scheduled time for the cessation of the first innings.
- If the team batting first is dismissed in less than 50 overs, the team batting second shall be entitled to bat for 50 overs.
- If the team fielding second fails to bowl 50 overs by the scheduled cessation time, the hours of play shall be extended until the required number of overs has been bowled or a result is achieved.
- Penalties shall apply for slow over rates (refer ICC Code of Conduct).

12.4.2 Delayed or Interrupted Matches

- a) Delay or Interruption to the Innings of the Team Batting First (see Appendix 2)
 - i) When playing time has been lost the revised number of overs to be bowled in the match shall be based on a rate of 14.28 overs per hour, which is inclusive of the provision of drinks intervals, in the total remaining time available for play.
 - ii) The revision of the number of overs should ensure, whenever possible, that both teams have the opportunity of batting for the same number of overs. The team batting second shall not bat for a greater number of overs than the first team unless the latter completed its innings in less than its allocated overs. To constitute a match, a minimum of 20 overs have to be bowled to the side batting second, subject to the innings not being completed earlier. subject to a result not being achieved earlier.
 - iii) As soon as the total minutes of playing time remaining is less than the completed overs faced by Team 1 multiplied by 4.2, then the first innings is terminated and the provisions of 12.4.2 (b) below take effect.
 - iv) A fixed time will be specified for the commencement of the interval, and also the close of play for the match, by applying a rate of 14.28 overs per hour. When calculating the length of playing time available for the match, or the length of either innings, the timing and duration of all relative delays, extensions in playing hours, interruptions in play, and intervals, excluding those for drinks, will be taken into consideration. This calculation must not cause the match to finish earlier than the original or rescheduled time for cessation of play on the final scheduled day for play. If required the original time shall be extended to allow for one extra over for each team.

If the team fielding first fails to bowl the revised number of overs by the specified time, play shall continue until the required number of overs have been bowled or the innings is completed.
 - v) Penalties shall apply for slow over rates (refer to ICC Code of Conduct).
- b) Delay or Interruption to the innings of the Team Batting Second
 - i) When playing time has been lost and, as a result, it is not possible for the team batting second to have the opportunity of receiving its allocated, or revised allocation of overs in the playing time available, the number of overs shall be reduced at a rate of 14.28 overs per hour, which is inclusive of the provision of drinks intervals, in respect of the lost playing time. Should the calculations result in a fraction of an over the fraction shall be ignored.
 - ii) In addition, should the innings of the team batting first have been completed prior to the scheduled, or re-scheduled time for the commencement of the interval, then any calculation relating to the revision of overs shall not be effective until an amount of time equivalent to that by which the second innings started early has elapsed.

- iii) To constitute a match, a minimum of 20 overs have to be bowled to the team batting second subject to a result not being achieved earlier.
- iv) The team batting second shall not bat for a greater number of overs than the first team unless the latter completed its innings in less than its allocated overs.
- v) A fixed time will be specified for the close of play by applying a rate of 14.28 overs per hour. With the exception of drinks intervals, the timing and duration of all relative delays, extensions in playing hours and interruptions in play, will be taken into consideration in specifying this time.
- vi) If the team fielding second fails to bowl the revised overs by the scheduled or re-scheduled close of play, the hours of play shall be extended until the overs have been bowled or a result achieved.
- vii) Penalties shall apply for slow over rates (refer ICC Code of Conduct).

12.5 Extra Time

In all matches where the start of play is delayed or play is suspended, the scheduled hours of play shall be extended up to an agreed maximum between the ICC and the Tournament Organisers.

12.6 Number of Overs per Bowler

No bowler shall bowl more than 10 overs in an innings.

In a delayed or interrupted match where the overs are reduced for both teams or for the team bowling second, no bowler may bowl more than one-fifth of the total overs allowed.

Where the total overs are not divisible by 5, one additional over shall be allowed to the maximum number per bowler necessary to make up the balance.

In the event of a bowler breaking down and being unable to complete an over, the remaining balls will be allowed by another bowler. Such part of an over will count as a full over only in so far as each bowler's limit is concerned.

Where possible the scoreboard shall show the total number of overs bowled and the number of overs bowled by each bowler.

12.7 Law 12.4 – The toss

Law 12.4 shall be replaced by the following:

The captains shall toss for the choice of innings, on the field of play and in the presence of the ICC Tournament Referee, who shall supervise the toss. The toss shall take place not earlier than 30 minutes, nor later than 15 minutes before the scheduled or any re-scheduled time for the match to start. Note, however, the provisions of Law 1.3 (Captain).

Note: Law 12.5 requiring the captain of the side winning the toss to notify the opposing captain as soon as the toss is completed of his decision to bat or to field first shall apply.

13 LAW 13 - THE FOLLOW-ON

Law 13 shall not apply.

14 LAW 14 - DECLARATION AND FORFEITURE

Law 14 shall not apply.

15 LAW 15 - INTERVALS

Law 15 shall apply subject to the following:

15.1 Law 15.5 - Changing agreed times for intervals - Interval between Innings

If the innings of the team batting first is completed prior to the scheduled time for the interval, the interval shall take place immediately and the innings of the team batting second will commence correspondingly earlier providing that this does not lead to an interval occurring more than 30 minutes prior to the scheduled interval.

If the innings of the team batting first is completed more than 30 minutes prior to the scheduled interval a 10 minute break will occur and the team batting second will commence its innings and the interval will occur as scheduled.

Where the innings of the side batting first is delayed or interrupted, the length of the interval will be reduced as follows:

- i) If up to 15 minutes of actual playing time is lost (total playing time lost less any extra time provided), then the interval will be reduced by the amount of actual playing time lost.
- ii) If more than 15 minutes of actual playing time is lost (total playing time lost less any extra time provided), then the interval will be reduced to 30 minutes (subject to (iii) below).
- iii) Note: The prescribed interval timings above may be reduced further by the ICC Match Referee taking into account the intention of not having a prolonged interval after a lengthy interruption close to the conclusion of the innings of the team batting first. However, the minimum interval shall not be less than ten minutes.

15.2 Law 15.9 - Intervals for Drinks

Two drinks breaks per session shall be permitted, each 1 hour 10 minutes apart. The provisions of Law 15.9 shall be strictly observed except that under conditions of extreme heat the umpires may permit extra intervals for drinks.

An individual player may be given a drink either on the boundary edge or at the fall of a wicket, on the field, provided that no playing time is wasted. No other drinks shall be taken onto the field without the permission of the umpires. Any player taking drinks onto the field shall be dressed in proper cricket attire (subject to the wearing of bibs – refer to the note in clause 2.1.3).

16 LAW 16 - START OF PLAY; CESSATION OF PLAY

Law 16 shall apply subject to the following (see also clauses 15 and 12.4):

16.1 Law 16.1 – Start and Cessation Times

To be determined by the ICC and the Tournament Organisers subject to there being 2 sessions of 3.5 hours each, separated by a 45 minute interval between innings.

Note: The playing hours of matches scheduled to take place at venues where dew is likely to be a factor should be determined so as to ensure that the effect of any dew is minimised.

16.2 Laws 16.6, 16.7 and 16.8 shall not apply.

16.3 Laws 16.9, 16.10, and 16.11 shall apply in so far as they are relevant to a one innings limited overs type match.

16.4 Minimum Over Rates

The minimum over rate to be achieved in matches will be 14.28 overs per hour.

The actual over rate will be calculated at the end of the match by the umpires.

In calculating the actual over rate for the match, allowances will be given for the actual time lost as a result of any of the following:

- 16.4.1 treatment given to a player by an authorised medical personnel on the field of play;
- 16.4.2 a player being required to leave the field as a result of a serious injury;
- 16.4.3 all third umpire referrals and consultations;
- 16.4.4 time wasting by the batting side; and
- 16.4.5 all other circumstances that are beyond the control of the fielding side.

In the event of any time allowances being granted to the fielding team under 16.4.4 above (time wasting by batting team), then such time shall be deducted from the allowances granted to such batting team in the determination of its over rate.

If a side is bowled out within the time determined for that innings pursuant to these playing conditions (taking into account all of the time allowances set out above), the fielding side shall be deemed to have complied with the required minimum over rate.

17 LAW 17 - PRACTICE ON THE FIELD

Law 17.1 shall apply subject to the following:

17.1 Practice on the pitch or rest of the square

Law 17.1 shall apply subject to the following:

- a) The use of the square for practice on any day of any match will be restricted to any netted practice area or bowling strips specifically prepared on the edge of the square for that purpose.
- b) Bowling practice on the bowling strips referred to in (a) above shall also be permitted during the interval (and change of innings if not the interval) unless the umpires consider that, in the prevailing conditions of ground and weather, it will be detrimental to the surface of the square.

17.2 Law 17.3 - Practice on the outfield between the call of play and the call of time

Law 17.3 shall apply save that Law 17.3 (c) shall be replaced with the following:

- c) There shall be no bowling or batting practice on the outfield. Bowling a ball, using a short run up to a player in the outfield is not to be regarded as bowling practice but shall be subject to the law.

18 LAW 18 - SCORING RUNS

Law 18 shall apply.

19 LAW 19 - BOUNDARIES

19.1 Law 19.1 - The Boundaries of the Field of Play

The playing area shall be a minimum of 140 yards (128.01 metres) from boundary to boundary square of the pitch. The pitch shall be a minimum 60 yards (54.86 metres) from one boundary square of the pitch. When this minimum distance is used, the pitch has to be a minimum 80 yards (73.15 metres) from the opposite square boundary. The straight boundary at both ends of the pitch shall be a minimum of 60 yards (54.86 metres). Distances shall be measured from the centre of the pitch to be used.

On large grounds the aim shall be to provide the largest playing area, subject to no boundary exceeding 90 yards (82.29 meters) from the centre of the pitch to be used.

19.2 Law 19.2 - Defining the Boundary - Boundary Marking

The following shall apply in addition to Law 19.2:

All boundaries must be designated by a rope, painted line with flags or similar object of a minimum standard as authorised by the ICC from time to time. Where appropriate the rope should be a required minimum distance (3 yards (2.74 metres) minimum) inside the perimeter fencing or advertising signs. For grounds with a large playing area, the maximum length of boundary should be used before applying the minimum 3 yards (2.74 metres) between the boundary and the fence.

19.3 Law 19.3 - Scoring a Boundary

The following shall apply in addition to Law 19.3:

If an unauthorized person enters the playing arena and handles the ball, the umpire at the bowler's end shall be the sole judge of whether the boundary allowance should be scored or the ball be treated as still in play or called dead ball if a batsman is liable to be out as a result of the unauthorized person handling the ball. See also Law 19.1 (c).

20 LAW 20 - LOST BALL

Law 20 shall apply.

21 LAW 21 - THE RESULT

Law 21 shall apply subject to the following:

21.1 Law 21.1 - A Win - Two Innings Match

Law 21.1 shall not apply.

21.2 Law 21.2 - A Win - One Innings Match

Law 21.2 shall apply in addition to the following:

21.2.1 Save for circumstances where a match is awarded to a team as a consequence of the opposing teams refusal to play (Law 21.3), a result can be achieved only if both teams have had the opportunity of batting for at least 20 overs, unless one team has been all out in less than 20 overs or unless the team batting second scores enough runs to win in less than 20 overs.

- 21.2.2 Save for circumstances where a match is awarded to a team as a consequence of the opposing teams refusal to play (Law 21.3), all matches in which both teams have not had an opportunity of batting for a minimum of 20 overs, shall be declared no result.

21.3 Law 21.3 – Umpire (Referee) Awarding a Match

Law 21.3 shall be replaced by the following:

- a) A match shall be lost by a side which either
 - i) concedes defeat or
 - ii) in the opinion of the ICC Tournament Referee refuses to play and the Referee shall award the match to the other side.
 - b) If an umpire considers that an action by any player or players might constitute a refusal by either side to play then the umpires together shall inform the ICC Tournament Referee of this fact. The ICC Tournament Referee shall together with the umpires ascertain the cause of the action. If the ICC Tournament Referee, after due consultation with the umpires, then decides that this action does constitute a refusal to play by one side, he shall so inform the captain of that side. If the captain persists in the action the ICC Tournament Referee shall award the match in accordance with (a)(ii) above.*
 - c) If action as in (b) above takes place after play has started and does not constitute a refusal to play the delay or interruption in play shall be dealt with in the same manner as provided for in clauses 12.4.2 and 15.1 above.
- * N/B In addition to the consequences of any refusal to play prescribed under this clause, any such refusal, whether temporary or final, may result in disciplinary action being taken against the captain and team responsible under the ICC Code of Conduct.

21.4 Law 21.4 – Matches in which there is an agreement under Law 12.1 (b)

Law 21.4 shall not apply.

21.5 Law 21.4 - A Tie

Law 21.4 shall apply in addition to the following:

- 21.5.1 If the scores are equal, the result shall be a tie and no account shall be taken of the number of wickets which have fallen.
- 21.5.2 In the round-robin matches, points are allocated for a tie as per Clause 21.10.
- 21.5.3 In the final and playoff matches, the teams shall compete in a Super Over to determine the winners. Refer Clause 21.10.3.

21.6 Law 21.5 - A Draw

Law 21.5 shall not apply.

21.7 Prematurely Terminated Matches - Calculation of the Target Score

21.7.1 Interrupted Matches - Calculation of the Target Score

If, due to suspension of play after the start of the match, the number of overs in the innings of either team has to be revised to a lesser number than originally allotted (minimum of 20 overs), then a revised target score (to win) should be set for the number of overs which the team batting second will have the opportunity of facing. This revised target is to be calculated using the current Duckworth/Lewis method. The target set will always be a whole number and one run less will constitute a Tie. (refer Duckworth/Lewis regulations)

21.7.2 Prematurely Terminated Matches

If the innings of the side batting second is suspended (with at least 20 overs bowled) and it is not possible for the match to be resumed, the match will be decided by comparison with the D/L 'Par Score' determined at the instant of the suspension by the Duckworth/Lewis method (refer Duckworth/Lewis regulations). If the score is equal to the par score, the match is a Tie. Otherwise the result is a victory, or defeat, by the margin of runs by which the score exceeds, or falls short of, the Par Score.

21.8 Correctness of Result

Any query on the result of the match as defined in Laws 21.2, 21.3, 21.5, 21.8 and 21.10 (as modified by these regulations) shall be resolved as soon as possible and a final decision made by the umpires at close of play.

21.9 Event Format

The tournament will be contested by a pre-determined number of teams. Unless specified as a two group tournament each team will play every other team once in a round-robin format.

Points will be allocated for each match in accordance with the system described in clause 21.10 of these playing conditions.

Unless specified, following the completion of the round-robin matches the top 2 teams (as determined in 21.10) will contest the final with all other teams playing ranking play-offs.

Therefore the games will be as follows:

On completion of the round-robin matches 1st and 2nd (as determined in 21.10) will play the final.

On completion of the round-robin matches 3rd and 4th (as determined in 21.10) will play the 3rd and 4th play-off.

On completion of the round-robin matches 5th and 6th (as determined in 21.10) will play the 5th and 6th play-off.

21.10 Standings

21.10.1 Preliminary Matches

The following points system shall apply:

Win	2
Tie or No Result	1
Loss	0

21.10.2 Round-Robin Matches

In the event of teams finishing on equal points at the end of the round-robin matches, the progression to the ranking play-offs will be decided in the following order of priority:

- a) The team with the most number of wins in the round-robin matches will be placed in the higher position.
- b) If there are teams with equal points and equal wins in the round-robin matches then in such case the team with the higher net run rate in these matches will be placed in the higher position (refer to 21.10.4 below for the calculation of net run rate).

- c) If following the net run rate calculation above there are teams which are still equal, then the team which was the winner of the head to head match played between them will be placed in the higher position.
- d) In the highly unlikely event that teams cannot be separated by the above this will be done by drawing lots.

Please note in a match declared as no result, run rate is not applicable.

21.10.3 Final and Ranking Play-offs

In the event of the final or ranking play-off being tied or there is no result, the following shall apply:

- 1 Tied match – the teams shall compete in a SuperOver to determine the final positions (refer to Appendix 6).
- 2 If following a tie, weather conditions prevent the SuperOver from being completed, or if the match is a no result, the teams shall be ranked according to their final position at the end of the round robin matches.

21.10.4 Net Run Rate

A team's net run rate is calculated by deducting from the average runs per over scored by that team throughout the competition, the average runs per over scored against that team throughout the competition.

In the event of a team being all out in less than its full quota of overs, the calculation of its net run rate of both teams shall be based on the full quota of overs to which the batting team would have been entitled and not on the number of overs in which the team was dismissed.

Note: Any play during a SuperOver is excluded from these calculations.

Only those matches where results are achieved will count for the purpose of net run rate calculations. Where a match is abandoned, but a result is achieved under Duckworth/Lewis, for net run rate purposes Team 1 will be accredited with Team 2's Par Score on abandonment off the same number of overs faced by Team 2. Where a match is concluded but with Duckworth/Lewis having been applied at an earlier point in the match, Team 1 will be accredited with 1 run less than the final target score for Team 2 off the total number of overs allocated to Team 2 to reach the target.

In circumstances where a match (and the points for such match) is awarded to a team as a result of the other team's refusal to play, either by the ICC Tournament Referee in accordance with Law 21.3 (a)(ii) as read with playing condition 21.3 or in accordance with the provisions of the relevant event agreements signed by the participating teams, the net run rate of the defaulting team shall be affected in that the full 50 overs of the defaulting team's innings in such forfeited match shall be taken into account in calculating the average runs per over of the defaulting team over the course of the relevant portion of the competition. For the avoidance of doubt the runs scored and overs bowled in such forfeited match will not be taken into account when calculating the net run rate of the team to whom the match was awarded.

- 21.10.5 In the event of any dispute the ICC Event Technical Committee may be called on to make a ruling and its ruling will be final.

22 LAW 22 - THE OVER

Law 22 shall apply subject to the addition of the following to Law 22.5:

22.1 Law 22.5 - Umpire Miscounting

Whenever possible the third umpire or the scorers shall inform the on-field umpires if the over has been miscounted.

23 LAW 23 - DEAD BALL

Law 23 shall apply subject to the addition of the following to Law 23.4.

23.1 Law 23.4 – Umpire calling and signalling ‘Dead Ball’

In a match where cameras are being used on or over the field of play (e.g. Spydercam), should a ball that has been hit by the batsman make contact, while still in play, with the camera, its apparatus or its cable, either umpire shall call and signal ‘dead ball’. The ball shall not count as one of the over and no runs shall be scored. If the delivery was called a no ball it shall count and the no ball penalty applied, including if appropriate a free hit from the next delivery. No other runs (including penalty runs) apart from the no ball penalty shall be scored.

Should a ball thrown by a fielder make contact with a camera on or over the field of play, its apparatus or its cable, either umpire shall call and signal dead ball. Unless this was already a no-ball or wide, the ball shall count as one of the over. All runs scored to that point shall count, plus the run in progress if the batsmen have already crossed.

24 NO BALL

Law 24 shall apply subject to the following:

24.1 Law 24.1 (b) Mode of Delivery

Law 24.1 (b) shall be replaced by the following:

The bowler may not deliver the ball underarm. If a bowler bowls a ball underarm the umpire shall call and signal no ball, and the ball is to be re-bowled overarm.

24.2 Free Hit After a Foot-Fault No Ball

In addition to the above, the delivery following a no ball called for a foot fault (Law 24.5) shall be a free hit for whichever batsman is facing it. If the delivery for the free hit is not a legitimate delivery (any kind of no ball or a wide ball), then the next delivery will become a free hit for whichever batsman is facing it.

For any free hit, the striker can be dismissed only under the circumstances that apply for a no ball, even if the delivery for the free hit is called wide ball.

Field changes are not permitted for free hit deliveries unless there is a change of striker (the provisions of clause 41.2 shall apply).

The umpires will signal a free hit by (after the normal No Ball signal) extending one arm straight upwards and moving it in a circular motion.

24.3 Fair Delivery - The feet

Law 24.5 shall apply, subject to the final paragraph being replaced by the following:

If the bowler's end umpire is satisfied that any of these three conditions have not been met, he shall call and signal No ball.

25 LAW 25 - WIDE BALL**25.1 Law 25.1 - Judging a Wide**

Law 25 shall apply with the following addition to Law 25.1:

Umpires are instructed to apply very strict and consistent interpretation in regard to this Law in order to prevent negative bowling wide of the wicket.

Any offside or legside delivery which in the opinion of the umpire does not give the batsman a reasonable opportunity to score shall be called a wide.

A penalty of one run for a wide shall be scored. This penalty shall stand in addition to any other runs which are scored or awarded. All runs, which are run or result from a wide ball, which is not a no ball, shall be scored wide balls.

26 LAW 26 - BYE AND LEG BYE

Law 26 shall apply.

27 LAW 27 - APPEALS

Law 27 shall apply.

28 LAW 28 - THE WICKET IS DOWN

Law 28 shall apply.

29 LAW 29 - BATSMAN OUT OF HIS GROUND

Law 29 shall apply.

30 LAW 30 - BOWLED

Law 30 shall apply.

31 LAW 31 - TIMED OUT

Law 31 shall apply.

32 LAW 32 - CAUGHT

Law 32 shall apply.

33 LAW 33 - HANDLED THE BALL

Law 33 shall apply.

34 LAW 34 - HIT THE BALL TWICE

Law 34 shall apply.

35 LAW 35 - HIT WICKET

Law 35 shall apply.

36 LAW 36 - LEG BEFORE WICKET

Law 36 shall apply.

37 LAW 37 - OBSTRUCTING THE FIELD

Law 37 shall apply.

For the avoidance of doubt, if an umpire feels that a batsman, in running between the wickets, has significantly changed his direction without probable cause and thereby obstructed a fielder's attempt to effect a run out, the batsman should, on appeal, be given out, obstructing the field. It shall not be relevant whether a run out would have occurred or not.

If the change of direction involves the batsman crossing the pitch, Law 42.14 shall also apply.

38 LAW 38 - RUN OUT

Law 38 shall apply.

39 LAW 39 - STUMPED

Law 39 shall apply.

40 LAW 40 - THE WICKET-KEEPER

Law 40 shall apply.

41 LAW 41 - FIELDER

Law 41 shall apply subject to the following:

41.1 Law 41.1 - Protective Equipment

The following shall apply in addition to Law 41.1:

The exchanging of protective equipment between members of the fielding side on the field shall be permitted provided that the umpires do not consider that it constitutes a waste of playing time.

41.2 Restrictions on the Placement of Fieldsmen

41.2.1 At the instant of delivery, there may not be more than 5 fieldsmen on the leg side.

41.2.2 In addition to the restriction contained in clause 41.2.1 above, further fielding restrictions shall apply to certain overs in each innings. The nature of such fielding restrictions and the overs during which they shall apply (hereinafter referred to as the Powerplay Overs) are set out in the following paragraphs.

41.2.3 The following fielding restrictions shall apply:

- a) Two semi-circles shall be drawn on the field of play. The semi-circles shall have as their centre the middle stump at either end of the pitch. The radius of each of the semi-circles shall be 30 yards (27.43 metres). The semi-circles shall be linked by two parallel straight lines drawn on the field. (Refer attached Appendix 5). The fielding restriction areas should be marked by continuous painted white lines or 'dots' at 5 yard (4.57 metres) intervals, each 'dot' to be covered by a white plastic or rubber (but not metal) disc measuring 7 inches (18 cm) in diameter.

During the **first block of Powerplay Overs** (as set out below), only two fieldsmen shall be permitted outside this fielding restriction area at the instant of delivery.

During the **second block of Powerplay Overs** only three fieldsmen shall be permitted outside this fielding restriction area at the instant of delivery.

- b) Two inner circles shall be drawn on the field of play. The circles shall have as their centres the centrepoint of the popping crease at either end of the pitch. The radius of each of the circles shall be 15 yards (13.72 metres). These fielding restriction areas should be marked by 'dots'. The segment of the circles reserved for the slip positions shall not be demarcated (refer attached Appendix 5).

During the **first** block of Powerplay Overs (in an uninterrupted innings, the first 10), there must be a minimum of two stationary fieldsmen within the applicable fielding restriction area measured from the striker's end at the instant of delivery. When a fast bowler is bowling the two stationary fieldsmen may be permitted to stand deeper than 15 yards (13.72 metres) (in the undemarcated area) provided only that they are standing in slip, leg slip or gully positions.

- 41.2.4 During the non Powerplay Overs, no more than **four** fieldsmen shall be permitted outside the fielding restriction area referred to in clause 41.2.3 (a) above.
- 41.2.5 Subject to the provisions of 41.2.6 below, the Powerplay Overs shall apply for 15 overs per innings to be taken as follows:
 - a) The first block of Powerplay Overs (block of 10 overs for an uninterrupted match) shall be at the commencement of the innings.
 - b) The second block of Powerplay Overs (block of 5 overs for an uninterrupted match) shall be taken at the discretion of either of the batsmen at the wicket. In an innings of scheduled duration of between 41 and 50 overs, it may not be completed later than the 40th over. (No equivalent restriction applies to innings of shorter scheduled duration.)
 - c) A batsman must nominate his team's Powerplay no later than the moment at which the umpire reaches the stumps at the bowler's end for the start of the next over.
 - d) Once a batsman has nominated a Powerplay, the decision can not be reversed.
 - e) Should the batting side choose not to exercise their discretion, their Powerplay Overs will automatically commence at the latest available point in the innings (e.g. in a 50 over innings, this will begin at the start of the 36th over).
- 41.2.6 In circumstances when the number of overs of the batting team is reduced, the number of Powerplay Overs shall be reduced in accordance with the table below. For the sake of clarity, it should be noted that the table shall apply to both the 1st and 2nd innings of the match.

INNINGS DURATION	FIRST POWERPLAY	SECOND POWERPLAY	POWERPLAY TOTAL
20 - 21	4	2	6
22 - 24	5	2	7
25 - 28	5	3	8
29 - 31	6	3	9
32 - 34	7	3	10
35 - 38	7	4	11
39 - 41	8	4	12
42 - 44	9	4	13
45 - 48	9	5	14
49	10	5	15

41.2.7 Each block of Powerplay Overs must commence at the start of an over.

41.2.8 If play is interrupted not during the Powerplay overs, then on resumption, it is necessary to determine how any remaining Powerplay overs should be allocated. The total number of Powerplay overs for the innings is derived from the table in 41.2.6. Any Powerplay overs already taken prior to the interruption will be deemed to have been from the initial allocation followed by the batting side's allocation. The decision of the batting side of when to take any remaining Powerplay overs is made in the usual way.

Illustrations of 41.2.8:

A match starts as 50 overs, is interrupted after 12 overs and reduced to 43 overs. (The first 10 overs have been Powerplays (PP); the next two were not.) The new PP allocation is 9+4, so there are 3 overs left for the batting side. These must start no later than the 38th over in order to be completed by the 40th over.

41.2.9 If play is interrupted during the first Powerplay and on resumption the overs required to be bowled in that Powerplay have already been exceeded, then the second Powerplay will be assumed to have been taken immediately and will continue until it is completed.

Illustrations of 41.2.9

A 50 over innings is interrupted after 9.3 overs, and on resumption has been reduced to 43 overs. Powerplay overs are 9+4. 2nd Powerplay is in progress with 0.3 out of the 4 overs completed, i.e. it covers overs 10 to 13. The fielding restrictions relating to the second powerplay take immediate effect on resumption.

41.2.10 If following an interruption, on resumption the total number of Powerplay Overs for the innings has already been exceeded, then there will be no further Powerplay deliveries bowled in the innings. Note that this is the only circumstance under which the Powerplay status can be changed during an over.

Illustrations of 41.2.10

A 45 over innings is interrupted after 8.3 overs, and on resumption has been reduced to 28 overs. Powerplay overs are 5+3. All Powerplay overs have been completed. Non-Powerplay restrictions take effect immediately and do not need to wait until the end of the over.

- 41.2.11 If following an interruption while a Powerplay is not in progress, it is found on resumption that the recalculated number of Powerplay Overs remaining exceeds the number of overs to be bowled in the innings, then the Powerplays will commence at the start of the next over, with fewer than the scheduled number of Powerplay Overs being bowled in the innings.

Illustration of 41.2.11:

A 41 over innings in which only the 1st Powerplay has been taken is interrupted after 35.1 overs and reduced to 39 overs. Powerplay overs are still 8+4. Powerplays automatically resume for the start of the next over, but only 11 of the 12 scheduled Powerplay overs can be bowled in the innings.

- 41.2.12 At the commencement of the second block of Powerplay Overs, the umpire shall signal such commencement to the scorers by rotating his arm in a large circle.
- 41.2.13 The umpire shall also indicate to the fielding captain before any signal is made that the batting side has chosen its Powerplay.
- 41.2.14 A light or other indicator shall be displayed on the scoreboard whenever the Powerplay Overs are being bowled, along with the number of overs remaining in the current block of Powerplay Overs.
- 41.2.15 The public address system shall be used to keep the spectators informed.
- 41.2.16 In the event of an infringement of any of the above fielding restrictions, the square leg umpire shall call and signal 'No Ball'

42 LAW 42 - FAIR AND UNFAIR PLAY

42.1 Law 42.3 - The Match Ball - Changing its Condition

Law 42.3 shall apply, subject to the following:

Law 42.3 (d) and (e) shall be replaced with the following:

If the umpires together agree that the deterioration in the condition of the ball is greater than is consistent with the use it has received, they shall consider that there has been a contravention of this Law. They shall then decide together whether they can identify the player(s) responsible for such conduct.

42.1.1 If it is possible to identify the player(s) responsible:

- Change the ball forthwith. The batsman at the wicket shall choose the replacement ball from a selection of six other balls of various degrees of usage (including a new ball) and of the same brand as the ball in use prior to the contravention.

Additionally the bowler's end umpire shall:

- Award 5 penalty runs to the batting side.
- Inform the captain of the fielding side of the reason for the action taken.
- Inform the captain of the batting side as soon as practicable of what has occurred.
- Together with the other umpire report the incident to the ICC Match Referee who shall take action as is appropriate against the player(s) responsible for the conduct under the ICC Code of Conduct.

42.1.2 If it is not possible to identify the player(s) responsible:

- a) Change the ball forthwith. The umpires shall choose the replacement ball for one of similar wear and of the same brand as the ball in use prior to the contravention.
- b) The bowler's end umpire shall issue the captain with a first and final warning, and
- c) Advise him that should there be any further incident by that team during the remainder of the match or subsequent matches within the event, steps 42.1.1 a) to e) above will be adopted, with the captain deemed under e) to be the player responsible should the umpires be unable to identify other player(s) responsible.

42.2 Law 42.4 - Deliberate Attempt to Distract Striker

Law 42.4 shall apply subject to the following:

In addition, the umpires shall report the incident to the ICC Tournament Referee under the ICC Code of Conduct.

42.3 Law 42.5 - Deliberate Distraction or Obstruction of Batsman

Law 42.5 shall apply subject to the following:

In addition, the umpire shall report the incident to the ICC Tournament Referee under the ICC Code of Conduct.

42.4 Law 42.6 - Dangerous and Unfair Bowling

42.4.1 Law 42.6 (a) - The Bowling of Fast Short Pitched Balls

Law 42.6 (a) shall be replaced by the following:

- a) A bowler shall be limited to two fast short-pitched deliveries per over.
- b) A fast short-pitched delivery is defined as a ball which passes or would have passed above the shoulder height of the striker standing upright at the popping crease.
- c) The umpire at the bowlers end shall advise the bowler and the batsman on strike when each fast short pitched delivery has been bowled.
- d) In addition, for the purpose of this regulation and subject to Clause 42.4.1 (f) below, a ball that passes above head height of the batsman, that prevents him from being able to hit it with his bat by means of a normal cricket stroke shall be called a wide.
- e) For the avoidance of doubt any fast short pitched delivery that is called a wide under this playing condition shall also count as **one** of the allowable short pitched deliveries in that over.
- f) In the event of a bowler bowling more than **two** fast short-pitched deliveries in an over as defined in Clause 42.4.1 (b) above, the umpire at the bowlers end shall call and signal no ball on each occasion. A differential signal shall be used to signify a fast short pitched delivery. The umpire shall call and signal 'no ball' and then tap the head with the other hand.
- g) If a bowler delivers a **third** fast short pitched ball in an over, the umpire, after the call of no ball and when the ball is dead, shall caution the bowler, inform the other umpire, the captain of the fielding side and the batsmen at the wicket of what has occurred. This caution shall apply throughout the innings.

- h) If there is a second instance of the bowler being no balled in the innings for bowling more than **two** fast short pitched deliveries in an over, the umpire shall advise the bowler that this is his final warning for the innings.
- i) Should there be any further instance by the same bowler in that innings, the umpire shall call and signal no ball and when the ball is dead direct the captain to take the bowler off forthwith. If necessary, the over shall be completed by another bowler, who shall neither have bowled the previous over, or part thereof, nor be allowed to bowl the next over, or part thereof.
- j) The bowler thus taken off shall not be allowed to bowl again in that innings.
- k) The umpire will report the occurrence to the other umpire, the batsmen at the wicket and as soon as possible to the captain of the batting side.
- l) The umpires will then report the matter to the ICC Match Referee who shall take such action as is considered appropriate against the captain and the bowler concerned. (Refer also to Law 42.1 Fair and Unfair Play - Responsibility of the Captains.)

The above is not a substitute for Clause 42.5 below which umpires are able to apply at any time.

42.4.2 Law 42.6 (b) Bowling of High Full Pitched Balls

Law 42.6 (b) shall be replaced by the following:

- a) Any delivery, which passes or would have passed on the full above waist height of the striker standing upright at the popping crease is deemed unfair, whether or not it is likely to inflict physical injury on the striker.
- b) In the event of a bowler bowling a high full pitched ball as defined in Clause 42.4.2 (a) above, the umpire at the bowler's end shall call and signal no ball.
- c) If, in the opinion of the umpire, such a delivery is considered likely to inflict physical injury on the batsman, the umpire at the bowler's end shall, in addition to calling and signalling no ball, when the ball is dead, caution the bowler and issue a first and final warning. The umpire shall inform the other umpire, the captain of the fielding side and the batsmen at the wicket of what has occurred.
- d) Should there be any further instance (where a high full pitched ball is bowled and is considered likely to inflict physical injury on the batsman) by the same bowler in that innings, the umpire shall in addition to calling and signalling no ball, when the ball is dead, direct the captain to take the bowler off forthwith. If necessary, the over shall be completed by another bowler, who shall neither have bowled the previous over, or part thereof, nor be allowed to bowl the next over, or part thereof.
- e) The bowler thus taken off shall not be allowed to bowl again in that innings.
- f) The umpire will report the occurrence to the other umpire, the batsman at the wicket and as soon as possible to the captain of the batting side.

- g) The umpires will then report the matter to the ICC Match Referee who shall take such action as is considered appropriate against the captain and the bowler concerned. (Refer also to Law 42.1 Fair and Unfair Play - Responsibility of the Captains.)

42.5 Law 42.7 - Dangerous and Unfair Bowling - Action by the Umpire

Law 42.7 shall be replaced by the following:

Regardless of any action taken by the umpire as a result of a breach of Clauses 42.4.1, 42.4.2 and 42.6 the following shall apply at any time during the match:

42.5.1 The bowling of fast short pitched balls is unfair if in the opinion of the umpire at the bowler's end he considers that by their repetition and taking into account their length, height and direction, they are likely to inflict physical injury on the striker, irrespective of the protective clothing and equipment he may be wearing. The relative skill of the striker shall also be taken into consideration.

42.5.2 In the event of such unfair bowling, the umpire at the bowler's end shall adopt the following procedure:

- a) In the first instance the umpire shall call and signal no ball, caution the bowler and inform the other umpire, the captain of the fielding side and the batsmen of what has occurred.
- b) If this caution is ineffective, he shall repeat the above procedure and indicate to the bowler that this is a final warning.
- c) Both the above caution and final warning shall continue to apply even though the bowler may later change ends.
- d) Should there be any further instance by the same bowler in that innings, the umpire shall call and signal no ball and when the ball is dead direct the captain to take the bowler off forthwith. If necessary, the over shall be completed by another bowler, who shall neither have bowled the previous over, or part thereof, nor be allowed to bowl the next over, or part thereof. See Law 22.8. (Bowler Incapacitated or Suspended during an Over).
- e) The bowler thus taken off shall not be able to bowl again in that innings.
- f) The umpire will report the occurrence to the other umpire, the batsmen at the wicket and as soon as possible to the captain of the batting side.
- g) The umpires will then report the matter to the ICC Tournament Referee who shall take such action as is considered appropriate against the captain and the bowler concerned. (Refer also to Law 42.1 Fair and Unfair Play - Responsibility of the Captains.)

42.6 Law 42.8 - Deliberate Bowling of High Full Pitched Balls

Law 42.8 shall be replaced by the following:

If the umpire considers that a high full pitch delivery which is deemed dangerous and unfair as defined in Clause 42.4.2 was deliberately bowled, then the caution and warning process shall be dispensed with.

The umpire at the bowler's end shall:

- 42.6.1 Call and signal no ball.

- 42.6.2 When the ball is dead, direct the captain to take the bowler off forthwith.
- 42.6.3 Not allow the bowler to bowl again in that innings.
- 42.6.4 Ensure that the over is completed by another bowler, provided that the bowler does not bowl two overs or part thereof consecutively.
- 42.6.5 Report the occurrence to the other umpire, to the captain of the batting side and the ICC Tournament Referee who shall take such action as is considered appropriate against the captain and the bowler concerned. (Refer also to Law 42.1 Fair and Unfair Play Responsibility of the Captains).

42.7 Action by the Umpires for Dangerous and Unfair Bowling

Should the umpires initiate the caution and warning procedures set out in Clauses 42.4.1, 42.4.2, 42.5 and 42.6 such cautions and warnings are not to be cumulative.

42.8 Law 42.9 - Time Wasting by the Fielding Side

Law 42.9 shall apply subject to Law 42.9 (b) being replaced by the following:

If there is any further waste of time in that innings, by any member of the fielding side the umpire shall:

- 42.8.1 Call and signal dead ball if necessary, and;
- 42.8.2 Award 5 penalty runs to the batting side (see Law 42.17).
- 42.8.3 Inform the other umpire, the batsmen at the wicket and as soon as possible the captain of the batting side of what has occurred.
- 42.8.4 Report the occurrence to the ICC Match Referee who shall take such action as is considered appropriate against the captain and the team concerned under the ICC Code of Conduct.

42.9 Law 42.10 - Batsman Wasting Time

Law 42.10 shall apply, subject to the following:

If the incoming batsman is not in position to take guard or his partner not ready to receive the next ball within 2 minutes of the fall of the previous wicket, the action should be regarded by the umpires as time wasting and the provisions of Law 42.10 shall apply.

In addition, the umpires will report the incident to the ICC Tournament Referee under the ICC Code of Conduct.

42.10 Law 42.14 Batsman damaging the pitch

Law 42.14 shall apply.

See also clause 37 above.

42.11 Law 42.15 – Bowler attempting to run out non-striker before delivery

Law 42.15 shall be replaced by the following:

The bowler is permitted, before releasing the ball and provided he has not completed his usual delivery swing, to attempt to run out the non-striker. Whether the attempt is successful or not, the ball shall not count as one of the over. If the bowler fails in an attempt to run out the non-striker, the umpire shall call and signal Dead ball as soon possible.

42.12 Use of Electronic Communications Equipment

The use of electronic communication devices and equipment of any kind to communicate with players on the field of play shall not be permitted.

APPENDIX 1

All penalty runs in the Laws of Cricket (2000 5th Edition – 2013) apply in International Cricket.

APPENDIX 2A**Calculation sheet for use when a delay or interruptions occur in the First Innings****Time**

Net playing time available at start of the match	420 minutes	(A)
Time innings in progress	_____	(B)
Playing time lost	_____	(C)
Extra time available	_____	(D)
Time made up from reduced interval	_____	(E)
Effective playing time lost [C – (D + E)]	_____	(F)
Remaining playing time available [A - F]	_____	(G)
G divided by 4.2 (to 2 decimal places)	_____	(H)
Max overs per team [H/2] (round up fractions)	_____	(I)
Maximum overs per bowler [I / 5]	_____	
Duration of Powerplay Overs (initial, batting side)	_____ + _____	

Rescheduled Playing Hours

First session to commence or recommence	_____	(J)
Length of innings [I x 4.2] (round up fractions)	_____	(K)
Rescheduled first innings cessation time [J + (K – B)]	_____	(L)
Length of interval	_____	(M)
Second innings commencement time [L + M]	_____	(N)
Rescheduled second innings cessation time [N + K]	_____	*(O)

* Ensure that the match is not finishing earlier than the original or rescheduled cessation time by applying Clause 12.4.2 a) iv). If so, add at least one over to each team and recalculate (I) to (O) above to prevent this from happening.

APPENDIX 2B**Calculation sheet to check whether an interruption during the First Innings should terminate the innings**

Proposed re-start time	_____	(P)
Rescheduled cut-off time allowing for full use of any extra time provision	_____	(Q)
Minutes between P and Q	_____	(R)
Potential overs to be bowled [R / 4.2] (round up fractions)	_____	(S)
Number of complete overs faced to date in first innings	_____	(T)
If S is greater than T then revert to Appendix 2A		
If S is less than or equal to T then the first innings is terminated and go to Appendix 3A		

APPENDIX 3A

Calculation sheet for the start of the Second Innings

Maximum overs to be bowled:

(If first innings was terminated, S from Appendix 2B) _____ (A)

Scheduled length of innings: [$A \times 4.2$] (round up fractions) _____ (B)

Start time _____ (C)

Scheduled cessation time [$C + B$] _____ (D)

Overs per bowler and Fielding Restrictions

Maximum overs per bowler [$J / 5$] _____ overs

Duration of Powerplay overs (initial, batting side) _____ + _____

APPENDIX 3B

Calculation sheet for use when interruption occurs after the start of the Second Innings

Time

Time at start of innings _____ (A)

Time at start of interruption _____ (B)

Time innings in progress _____ (C)

Restart time _____ (D)

Length of interruption [$D - B$] _____ (E)

Additional time available: (Any unused provision for 'Extra Time' or for earlier than scheduled start of second innings) _____ (F)

Total playing time lost [$E - F$] _____ (G)

Overs

Maximum overs at start of innings _____ (H)

Overs lost [$G / 4.2$] (rounded down) _____ (I)

Adjusted maximum length of innings [$H - I$] _____ (J)

Rescheduled length of innings [$J \times 4.2$ rounded up] _____ (K)

Amended cessation time of innings [$D + (K - C)$] _____ (L)

Overs per bowler and Fielding Restrictions

Maximum overs per bowler [$J / 5$] _____ overs

Duration of Powerplay overs (initial, batting side) _____ + _____

APPENDIX 4 – CREASE MARKINGS

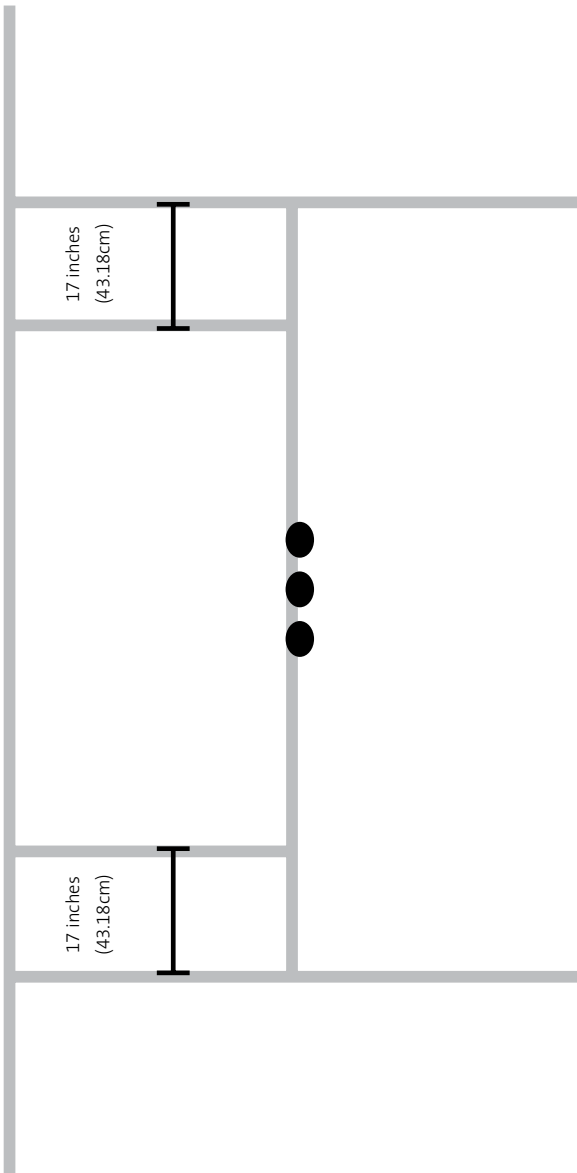

APPENDIX 5

Restriction of the placement of fieldsmen

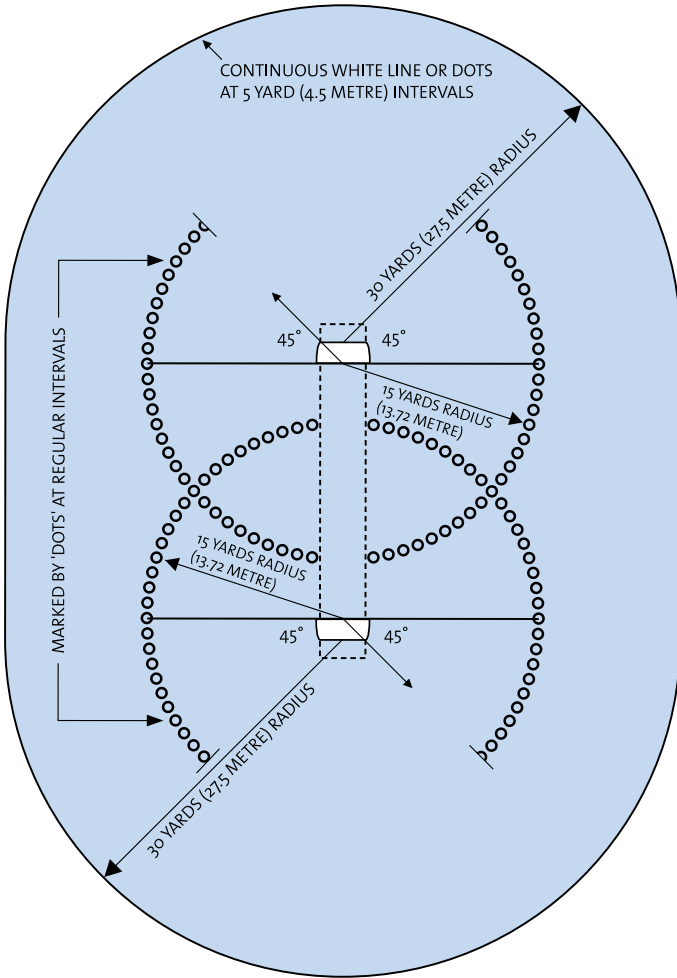

The final mark of the 15 yards radius shall be a line placed at an angle of 45°, measured from the popping crease at a point level with the middle stump.

APPENDIX 6

Procedure for the Super Over

The following procedure will apply should the provision for a **Super Over** be adopted in any match.

- 1 Subject to weather conditions the **Super Over** will take place on the scheduled day of the match at a time to be determined by the ICC Match Referee. In normal circumstances it shall commence 10 minutes after the conclusion of the match.
- 2 The amount of extra time allocated to the **Super Over** is the greater of (a) the extra time allocated to the original match less the amount of extra time actually utilised and (b) the gap between the actual end of the match and the time the original match would have been scheduled to finish had the whole of the extra time provision been utilised. Should play be delayed prior to or during the **Super Over** once the playing time lost exceeds the extra time allocated, the **Super Over** shall be abandoned. See clause 15.
- 3 The **Super Over** will take place on the pitch allocated for the match (the designated pitch) unless otherwise determined by the umpires in consultation with the ground authority and the ICC Match Referee.
- 4 The umpires shall stand at the same end as that in which they finished the match.
- 5 In both innings of the **Super Over**, the fielding side shall choose from which end to bowl.
- 6 Only nominated players in the main match may participate in the **Super Over**. Should any player (including the batsmen and bowler) be unable to continue to participate in the **Super Over** due to injury, illness or other wholly acceptable reasons, the relevant Laws and Playing Conditions as they apply in the main match shall also apply in the **Super Over**.
- 7 Any penance time being served in the main match shall be carried forward to the **Super Over**.
- 8 Each team's over is played with the same fielding restrictions as apply for the last over in a normal T20 International match.
- 9 The team batting second in the match will bat first in the **Super Over**.
- 10 The fielding captain or his nominee shall select the ball with which he wishes to bowl his over in the **Super Over** from the box of spare balls provided by the umpires. Such box to include the balls used in the main match, but no new balls. The team fielding first in the **Super Over** shall have first choice of ball. The team fielding second may choose to use the same ball as chosen by the team bowling first. If the ball needs to be changed, then playing conditions as stated for the main match shall apply.
- 11 The loss of two wickets in the over ends the team's one over innings.
- 12 In the event of the teams having the same score after the **Super Over** has been completed, if the original match was a tie under the D/L method, clause 14 immediately applies. Otherwise, the team whose batsmen hit the most number of boundaries combined from its two innings in both the main match and the **Super Over** shall be the winner.
- 13 If the number of boundaries hit by both teams is equal, the team whose batsmen scored more boundaries during its innings in the main match (ignoring the **Super Over**) shall be the winner.

- 14 If still equal, a count-back from the final ball of the **Super Over** shall be conducted. The team with the higher scoring delivery shall be the winner. If a team loses two wickets during its over, then any unbowled deliveries will be counted as dot balls. Note that for this purpose, the runs scored from a delivery is defined as the total team runs scored since the completion of the previous legitimate ball, i.e including any runs resulting from wides, no ball or penalty runs.

Example:

RUNS SCORED FROM:	TEAM 1	TEAM 2
Ball 6	1	1
Ball 5	4	4
Ball 4	2	1
Ball 3	6	2
Ball 2	0	1
Ball 1	2	6

In this example both teams scored an equal number of runs from the 6th and 5th ball of their innings. However team 1 scored 2 runs from its 4th ball while team 2 scored a single so team 1 is the winner.

- 15 Clause 2 examples:

Scheduled finish 5.00, 30 minutes extra time available, so scheduled finish time if the whole of the extra time provision is utilised is 5.30.

- No extra time is utilised in the original match which overruns ten minutes and finishes at 5.10. The **Super Over** is scheduled to start at 5.20 with 30 minutes extra time available. It starts on time but is interrupted at 5.25. Play must resume by 5.55 otherwise the **Super Over** is abandoned.
- 20 minutes of extra time was utilised, with the match scheduled to finish at 5.20, but it actually finishes at 5.10. Therefore the extra time allocated to the **Super Over** is the greater of a) 10 minutes (30 minutes extra time less 20 already utilised) and b) 20 minutes (the gap from the actual finish time of 5.10 and the scheduled finish had the full extra time been utilised of 5.30). The **Super Over** was due to start at 5.20, but is delayed by rain. It must therefore start by 5.40 or the **Super Over** is abandoned.
- The match finishes at 5.40 (having started 30 minutes late and overrun by 10 minutes). There is no extra time allocated to the **Super Over** which should start at 5.50. Any delay or interruption after 5.50 means the **Super Over** is abandoned.

ICC CODE OF CONDUCT FOR PLAYERS AND PLAYER SUPPORT PERSONNEL

ICC CODE OF CONDUCT FOR PLAYERS AND PLAYER SUPPORT PERSONNEL

	PAGE
Article 1	Scope and Application 13.2
Article 2	<i>Code of Conduct Offences</i> 13.3
Article 3	<i>Reporting an Alleged Offence Under the Code of Conduct</i> 13.9
Article 4	Notification Procedure 13.11
Article 5	The Disciplinary Procedure 13.12
Article 6	Standard of Proof and Evidence 13.19
Article 7	Sanctions on <i>Players and Player Support Personnel</i> 13.20
Article 8	Appeals 13.24
Article 9	Recognition of Decisions 13.27
Article 10	Amendment and Interpretation of The <i>Code Of Conduct</i> 13.27
Appendix 1	Definitions 13.28
Appendix 2	<i>Minimum Over Rate</i> Requirements, Calculation <i>Reporting and Disciplinary Process and Sanctions</i> 13.30
Appendix 3	<i>Match Fees</i> 13.33
Appendix 4	Expedited Procedure for <i>Code of Conduct Offences</i> Occurring During an <i>ICC Event</i> 13.34

INTRODUCTION

The ICC is the international federation responsible for the global governance of the sport of cricket and the Code of Conduct for Players and Player Support Personnel (the 'Code of Conduct') is adopted and implemented as part of the ICC's continuing efforts to maintain the public image, popularity and integrity of cricket by providing: (a) an effective means to deter any participant from conducting themselves improperly on and off the 'field-of-play' or in a manner that is contrary to the 'spirit of cricket'; and (b) a robust disciplinary procedure pursuant to which all matters of improper conduct can be dealt with fairly, with certainty and in an expeditious manner.

Unless otherwise indicated, references to Articles and Appendices are to articles and appendices of the *Code of Conduct*. Words in italicised text in the *Code of Conduct* are defined terms and their definitions are set out in Appendix 1.

ARTICLE 1 – SCOPE AND APPLICATION

- 1.1 All *Players* and *Player Support Personnel* are automatically bound by and required to comply with all of the provisions of the *Code of Conduct*. Accordingly, by their participation (in the case of a *Player*) or assistance in a *Player's* participation (in the case of a *Player Support Personnel*) in an *International Match*, such *Players* or *Player Support Personnel* shall be deemed to have agreed:
 - 1.1.1 that it is their personal responsibility to familiarise themselves with all of the requirements of the *Code of Conduct*, including what conduct constitutes an offence under the *Code of Conduct*;
 - 1.1.2 to submit to the exclusive jurisdiction of any *Match Referee*, *Judicial Commissioner* or *Appeal Panel* convened under the *Code of Conduct* to hear and determine charges brought (and any appeals in relation thereto) pursuant to the *Code of Conduct*; and
 - 1.1.3 not to bring any proceedings in any court or other forum that are inconsistent with the foregoing submission to the jurisdiction of the *Match Referee*, *Judicial Commissioner* or *Appeal Panel*.
- 1.2 All *Players* and *Player Support Personnel* shall continue to be bound by and required to comply with the *Code of Conduct* until he/she has not participated (in the case of a *Player*), or assisted a *Player's* participation (in the case of a *Player Support Personnel*) in an *International Match* for a period of three (3) months and the ICC shall continue to have jurisdiction over him/her under the *Code of Conduct* thereafter in respect of matters taking place prior to that point.
- 1.3 Without prejudice to Articles 1.1 and 1.2, the ICC and the *National Cricket Federations* shall be responsible for promoting *Code of Conduct* awareness and education amongst all *Players* and *Player Support Personnel*.
- 1.4 It is acknowledged that certain *Players* and *Player Support Personnel* may also be subject to other rules of *National Cricket Federations* that govern discipline and/or conduct, and that the same conduct of such *Players* and/or *Player Support Personnel* may implicate not only the *Code of Conduct* but also such other rules that may apply. For the avoidance of any doubt, *Players* and *Player Support Personnel* acknowledge and agree that: (a) the *Code of Conduct* is not intended to limit the responsibilities of any *Player* or *Player Support Personnel* under such other rules; and (b) nothing in such other rules shall be capable of removing, superseding or amending in any way the jurisdiction of the *Match Referee*, *Judicial Commissioner* or *Appeal Panel* to determine matters properly arising pursuant to the *Code of Conduct*.

- 1.5 For the avoidance of any doubt:
- 1.5.1 all *Umpires* and *Match Referees* officiating in any *International Matches* are automatically bound by and required to comply with all of the provisions of the *ICC Code of Conduct for Umpires and Referees*; and
 - 1.5.2 where a representative side of a *National Cricket Federation* participates in an *International Tour Match* against a domestic or invitational team, for the purposes of their participation in such *International Tour Match*:
 - 1.5.2.1 all *Players* and *Player Support Personnel* representing the *National Cricket Federation's* representative side are automatically bound by, required to comply with, and shall submit themselves to the jurisdiction of this Code of Conduct; and
 - 1.5.2.2 all *Players* or *Player Support Personnel* representing the domestic or invitational team shall not be bound by this *Code of Conduct*. Instead, such individuals will be bound by, required to comply with, and shall submit themselves to the jurisdiction of the relevant *National Cricket Federation's* own applicable rules of conduct.

ARTICLE 2 - CODE OF CONDUCT OFFENCES

The conduct described in Articles 2.1 – 2.5, if committed by a *Player* or *Player Support Personnel* shall amount to an offence by such *Player* or *Player Support Personnel* under the *Code of Conduct*.

COMMENT: Where considered helpful, guidance notes have been provided in text boxes beneath the description of a particular offence. Such notes are intended only to provide guidance as to the nature and examples of certain conduct that might be prohibited by a particular Article and should not be read as an exhaustive or limiting list of conduct prohibited by such Article.

2.1 Level 1 Offences:

- 2.1.1 Breach of the ICC's *Clothing and Equipment Regulations* during an *International Match*, save for breaches relating to a 'Commercial Logo' or a 'Player's Bat Logo' as those terms are defined therein.

NOTE: One of the core objectives of the ICC's *Clothing and Equipment Regulations* is to ensure appropriate and professional standards of appearance on the field of play and to prevent those practices that undermine that objective (for example the cover up/alteration of clothing and equipment with sticking plaster or marker pens, the wearing of batting pads painted with paint that subsequently fades or falls off and/or the use of prohibited logos).

For the avoidance of any doubt, there shall be no requirement that the *Umpire* must first provide a warning to the offending person to remove or cover up a prohibited logo before a breach of this Article can be established. It shall be a defence to a charge brought under this Article to show that a *Player* or *Player Support Personnel* was required by his/her *National Cricket Federation* to use the offending clothing or equipment.

- 2.1.2 Abuse of cricket equipment or clothing, ground equipment or fixtures and fittings during an *International Match*.

NOTE: Article 2.1.2 includes any action(s) outside the course of normal cricket actions, such as hitting or kicking the wickets and any action(s) which intentionally or negligently results in damage to the advertising boards, boundary fences, dressing room doors, mirrors, windows and other fixtures and fittings.

- 2.1.3 Showing dissent at an *Umpire's* decision during an *International Match*.

NOTE: Article 2.1.3 includes: (a) excessive, obvious disappointment with an *Umpire's* decision; (b) an obvious delay in resuming play or leaving the wicket; (c) shaking the head; (d) pointing or looking at the inside edge when given out lbw; (e) pointing to the pad or rubbing the shoulder when caught behind; (f) snatching the cap from the *Umpire*; (g) requesting a referral to the TV *Umpire* (other than in the context of a legitimate request for a referral as may be permitted in such *International Match*); and (h) arguing or entering into a prolonged discussion with the *Umpire* about his decision.

It shall not be a defence to any charge brought under this Article to show that the *Umpire* might have, or in fact did, get any decision wrong.

- 2.1.4 Using language or a gesture that is obscene, offensive or insulting during an *International Match*.

NOTE: Article 2.1.4 includes: (a) excessively audible or repetitive swearing; and (b) obscene gestures which are not directed at another person, such as swearing in frustration at one's own poor play or fortune. In addition, this offence is not intended to penalise trivial behaviour.

When assessing the seriousness of the breach, the *Umpire* shall be required to take into account the context of the particular situation and whether the words or gesture are likely to: (a) be regarded as obscene; (b) give offence; or (c) insult another person.

This offence is not intended to cover any use of language or gestures that are likely to offend another person on the basis of their race, religion, gender, colour, descent, national or ethnic origin. Such conduct is prohibited under the ICC's Anti-Racism Code and must be dealt with according to the procedures set out therein.

- 2.1.5 Excessive appealing during an *International Match*.

NOTE: For the purposes of Article 2.1.5, 'excessive' shall include: (a) repeated appealing of the same decision/appeal; (b) repeated appealing of different decisions/appeals when the bowler/fielder knows the batter is not out with the intention of placing the *Umpire* under pressure; or (c) celebrating a dismissal before the decision has been given. It is not intended to prevent loud or enthusiastic appealing.

- 2.1.6 Pointing or gesturing towards the pavilion by a bowler or other member of the fielding side upon the dismissal of a batsman during an *International Match*.

- 2.1.7 Public criticism of, or inappropriate comment in relation to an incident occurring in an *International Match* or any *Player, Player Support Personnel, Match official* or team participating in any *International Match*, irrespective of when such criticism or inappropriate comment is made.

NOTE: Without limitation, *Players and Player Support Personnel* will breach Article 2.1.7 if they publicly criticise the *Match officials* or denigrate a *Player* or team against which they have played in relation to incidents which occurred in an *International Match*. When assessing the seriousness of the breach, the context within which the comments have been made and the gravity of the offending comments must be taken into account.

For the avoidance of doubt, any posting by a *Player* or *Player Support Personnel* of comments on a social media platform (including, without limitation, Facebook, Twitter, YouTube, Google+, Pinterest and LinkedIn) shall be deemed to be 'public' for the purposes of this offence. Consequently a *Player* or *Player Support Personnel* may breach Article 2.1.7 where they criticize or make an inappropriate comment in relation to an incident occurring in an *International Match* or any *Player, Player Support Personnel, Match official* or team participating in any *International Match* in any posting they make on a social media platform.

- 2.1.8 Where the facts of the alleged incident are not adequately or clearly covered by any of the above offences, conduct that either: (a) is contrary to the spirit of the game; or (b) brings the game into disrepute.

NOTE: Article 2.1.8 is intended to be a 'catch-all' provision to cover all types of conduct of a minor nature that is not (and, because of its nature, cannot be) adequately covered by the specific offences set out elsewhere in the Code of Conduct.

By way of example, Article 2.1.8(a) may (depending upon the seriousness and context of the breach) prohibit the following: (a) the use of an illegal bat or illegal wicket-keeping gloves; (b) deliberate time wasting; (c) cheating during an *International Match*, including deliberate attempts to mislead the *Umpire*; (d) failure to comply with the provisions of clause 7.1 of the ICC Standard Test Match, ODI and Twenty20 *International Match Playing Conditions*; and (e) any conduct which is considered 'unfair play' under Law 42 of the Laws of Cricket.

By way of example, Article 2.1.8(b) may (depending upon the seriousness and context of the breach) prohibit the following: (a) public acts of misconduct; (b) unruly public behaviour; and (c) inappropriate comments which are detrimental to the interests of the game.

2.2 Level 2 Offences:

- 2.2.1 Showing serious dissent at an *Umpire's* decision during an *International Match*.

NOTE: Dissent, including the examples given in Article 2.1.3 above will be classified as 'serious' when the conduct contains an element of anger or abuse which is directed at the *Umpire* or the *Umpire's* decision or where there is excessive delay in resuming play or leaving the wicket or where there is persistent re-reference to the incident over time.

It shall not be a defence to any charge brought under this Article to show that the *Umpire* might have, or in fact did, get any decision wrong.

- 2.2.2 Breach of the ICC's *Clothing and Equipment Regulations* during an *International Match* relating to a 'Commercial Logo' or a 'Player's Bat Logo' as those terms are defined.

NOTE: Article 2.2.2 only relates to breaches of the regulations regarding 'Commercial Logos' and 'Player's Bat Logos'.

For the avoidance of any doubt, there shall be no requirement that the Umpire must first provide a warning to the offending person to remove or cover up a prohibited logo before a breach of this Article can be established.

It shall be a defence to a charge brought under this Article to show that a Player or Player Support Personnel is required by his/her National Cricket Federation to use the offending clothing or equipment.

- 2.2.3 Serious public criticism of, or inappropriate comment in relation to an incident occurring in an *International Match* or any *Player, Player Support Personnel, Match official* or team participating in any *International Match*, irrespective of when such criticism or inappropriate comment is made.

NOTE: Without limitation, *Players and Player Support Personnel* will breach this rule if they publicly criticise the *Match officials* or denigrate a *Player* or team against which they have played in relation to incidents which occurred in an *International Match*. When assessing the seriousness of the breach, the context within which the comments have been made and the gravity of the offending comments must be taken into account.

For the avoidance of doubt, any posting by a Player or Player Support Personnel of comments on a social media platform (including, without limitation, Facebook, Twitter, YouTube, Google+, Pinterest and LinkedIn) shall be deemed to be 'public' for the purposes of this offence. Consequently a Player or Player Support Personnel may breach Article 2.2.3 where they seriously criticize or make an inappropriate comment in relation to an incident occurring in an International Match or any Player, Player Support Personnel, Match official or team participating in any International Match in any posting they make on a social media platform.

- 2.2.4 Inappropriate and deliberate physical contact between *Players* in the course of play during an *International Match*.

NOTE: Without limitation, *Players* will breach this regulation if they deliberately walk or run into or shoulder another *Player*.

- 2.2.5 Charging or advancing towards the *Umpire* in an aggressive manner when appealing during an *International Match*.
- 2.2.6 Deliberate and malicious distraction or obstruction on the field of play during an *International Match*.

NOTE: This offence supplements and does not replace ICC Standard Test Match, ODI and Twenty20 *International Match Playing Conditions* clauses 42.2 and 42.3.

- 2.2.7 Throwing a ball (or any other item of cricket equipment such as a water bottle) at or near a *Player, Player Support Personnel, Umpire, Match Referee* or any other third person in an inappropriate and/or dangerous manner during an *International Match*.

NOTE: This regulation will not prohibit a *fielder* or *bowler* from returning the ball to the stumps in the normal fashion.

- 2.2.8 Using language or gesture(s) that is seriously obscene, seriously offensive or of a seriously insulting nature to another *Player, Player Support Personnel, Umpire, Match Referee* or any other third person during an *International Match*.

NOTE: It is acknowledged that there will be verbal exchanges between *Players* in the course of play. Rather than seeking to eliminate these exchanges entirely, *Umpires* will be required to report such conduct that falls below an acceptable standard. This offence is not intended to penalise trivial behaviour.

When assessing the seriousness of the breach, the *Umpire* shall be required to take into account the context of the particular situation and whether the words or gesture are likely to: (a) be regarded as seriously obscene; or (b) give serious offence; or (c) seriously insult another person.

This offence is not intended to cover any use of language or gestures that are likely to offend another person on the basis of their race, religion, gender, colour, descent, national or ethnic origin. Such conduct is prohibited under the ICC's Anti-Racism Code and must be dealt with according to the procedures set out therein.

- 2.2.9 Changing the condition of the ball in breach of Law 42.3 of the Laws of Cricket, as modified by ICC Standard Test Match, ODI and Twenty20 International Match Playing Conditions clause 42.1.

NOTE: This offence supplements and does not replace ICC Standard Test Match, ODI and Twenty20 International Match Playing Conditions clause 42.1

Any action(s) likely to alter the condition of the ball which were not specifically permitted under Law 42.3(a) may be regarded as 'unfair'. The following actions shall not be permitted (this list of actions is not exhaustive but included for illustrative purposes): (a) deliberately throwing the ball into the ground for the purpose of roughening it up; (b) applying any artificial substance to the ball; and applying any non-artificial substance for any purpose other than to polish the ball; (c) lifting or otherwise interfering with any of the seams of the ball; (d) scratching the surface of the ball with finger or thumb nails or any implement.

The *Umpires* shall use their judgment to apply the principle that actions taken to maintain or enhance the condition of the ball, provided no artificial substances are used, shall be permitted. Any actions taken with the purpose of damaging the condition of the ball or accelerating the deterioration of the condition of the ball shall not be permitted.

- 2.2.10 Any attempt to manipulate an *International Match* for inappropriate strategic or tactical reasons.

NOTE: Article 2.2.10 is intended to prevent the manipulation of *International Matches* for inappropriate strategic or tactical reasons (such as when a team deliberately loses a pool Match in an ICC Event in order to affect the standings of other teams in that ICC Event). It might also apply to the inappropriate manipulation of a net run rate or accumulation of bonus points or otherwise.

Article 2.2.10 is not intended to cover any corrupt or fraudulent acts (including any use of inside information and/or related betting activity). Such conduct is prohibited under the ICC's Anti-Corruption Code and must be dealt with according to the procedures set out therein.

The *Team Captain* of any team guilty of such conduct shall be held responsible (and subject to sanction) for any offence found to have been committed under this Article.

- 2.2.11 Where the facts of the alleged incident are not adequately or clearly covered by any of the above offences, conduct that either: (a) is contrary to the spirit of the game; or (b) brings the game into disrepute.

NOTE: Article 2.2.11 is intended to be a 'catch-all' provision to cover all types of conduct of a serious nature that is not (and, because of its nature, cannot be) adequately covered by the specific offences set out elsewhere in the Code of Conduct.

See guidance notes to Article 2.1.8 for examples of conduct that may (depending upon the seriousness and context of the breach) be prohibited under Article 2.2.11.

2.3 Level 3 Offences:

- 2.3.1 Intimidation of an *Umpire* or *Match Referee* whether by language or conduct (including gestures) during an *International Match*.

NOTE: Includes appealing in an aggressive or threatening manner.

- 2.3.2 Threat of assault on another *Player*, *Player Support Personnel* or any other person (including a spectator) during an *International Match*.

NOTE: This offence is not intended to cover threats of assault against *Umpires* or *Match Referees*, which are prohibited under Article 2.4.1.

- 2.3.3 Where the facts of the alleged incident are not adequately or clearly covered by any of the above offences, conduct that either: (a) is contrary to the spirit of the game; or (b) brings the game into disrepute.

NOTE: Article 2.3.3 is intended to be a 'catch-all' provision to cover all types of conduct of a very serious nature that is not (and, because of its nature, cannot be) adequately covered by the specific offences set out elsewhere in the Code of Conduct.

See guidance notes to Article 2.1.8 for examples of conduct that may (depending upon the seriousness and context of the breach) be prohibited under Article 2.3.3.

2.4 Level 4 Offences:

- 2.4.1 Threat of assault on an *Umpire* or *Match Referee* during an *International Match*.

- 2.4.2 Physical assault of another *Player*, *Player Support Personnel*, *Umpire*, *Match Referee* or any other person (including a spectator) during an *International Match*.

- 2.4.3 Any act of violence on the field of play during an *International Match*.

- 2.4.4 Where the facts of the alleged incident are not adequately or clearly covered by any of the above offences, conduct that either: (a) is contrary to the spirit of the game; or (b) brings the game into disrepute.

NOTE: Article 2.4.4 is intended to be a 'catch-all' provision to cover all types of conduct of an overwhelmingly serious nature that is not (and, because of its nature, cannot be) adequately covered by the specific offences set out elsewhere in the Code of Conduct.

See guidance notes to Article 2.1.8 for examples of conduct that may (depending upon the seriousness and context of the breach) be prohibited under Article 2.4.4.

2.5 *Minimum Over Rate Offences:*

Failure by a fielding team participating in an *International Match* to meet the *Minimum Over Rate* requirements contained in Appendix 2 constitutes an offence under this *Code of Conduct* by the relevant *Team Captain* and each of the *Players* in that fielding team according to the following:

- 2.5.1 where the actual over rate in any *Test Match* or any other *International Match* of at least four days in duration is up to (and including) five overs short of the *Minimum Over Rate*, or, in any *One Day International Match*, *Twenty20 International Match* or any other *International Match* of fifty (50) or twenty (20) overs per side, up to (and including) two overs short of the *Minimum Over Rate*, such an offence shall be considered a '**Minor Over Rate Offence**'.
- 2.5.2 where the actual over rate in any *Test Match* or any other *International Match* of at least four days in duration is more than five overs short of the *Minimum Over Rate*, or, in any *One Day International Match*, *Twenty20 International Match* or any other *International Match* of fifty (50) or twenty (20) overs per side, is more than two overs short of the *Minimum Over Rate*, such an offence shall be considered a '**Serious Over Rate Offence**'.

NOTE: *Subjective intent on behalf of the Team Captain to waste time is not required. It is sufficient to establish that the Minimum Over Rate was not met. To avoid liability under this offence the Team Captain would need to establish, on the balance of probabilities, that the shortfall was due to factors beyond his control and that the time allowances permitted by the Match officials in calculating the required over rate were not sufficient. The presence or absence of subjective intent and the extent of the shortfall shall be relevant in relation to the issue of penalty.*

The identity of the relevant Team Captain for the purposes of this Article 2.5 and Appendix 2 shall be determined in accordance with clause 1.3 of the Playing Conditions applicable to the particular International Match.

ARTICLE 3 - REPORTING AN ALLEGED OFFENCE UNDER THE CODE OF CONDUCT

NOTE: *Where a Code of Conduct offence is alleged to have occurred during, or in relation to an International Match that is played as part of an ICC Event, the Code of Conduct shall apply in full, but with a series of amendments to the reporting process (Article 3), disciplinary procedure (Article 5) and appeal process (Article 8) in order to ensure that any matters arising can be dealt with expediently. Such amendments are described in detail in Appendix 4.*

Where a Minimum Over Rate Offence may have occurred, see Appendix 2 for the reporting process, disciplinary process and sanctions that are to be applied.

- 3.1 Any one of the following individuals can *report* an alleged offence under the *Code of Conduct* (other than *Minimum Over Rate Offences* - as to which see Appendix 2) by lodging a *report* in the manner described in Article 3.2, below (a '**Report**'):
 - 3.1.1 an *Umpire* that officiated in the *International Match* during which the alleged offence was committed;
 - 3.1.2 the *Team Manager* or CEO of either of the two *National Cricket Federations* whose representative teams participated in the *International Match* during, or in relation to which, the alleged offence was committed;
 - 3.1.3 the ICC's *Chief Executive Officer*; or
 - 3.1.4 provided it is a *Level 3 Offence* or *Level 4 Offence* that is alleged to have been committed, the *Match Referee* that was appointed to officiate in the *International Match* during which the alleged offence was committed. (For the avoidance of any doubt, the *Match Referee* is not entitled to lodge a *Report* in relation to an alleged *Level 1 Offence* or *Level 2 Offence*).

- 3.2 All *Reports* must be completed on Form 'Rep 1' (or such other form as may be made available for such purpose by the ICC from time to time). All *Reports* must be signed and dated by the person lodging the *Report*.
- 3.2.1 Where the *Report* is lodged by any of the individuals described in Articles 3.1.1 or 3.1.2 in relation to:
- 3.2.1.1 a *Level 1 Offence* or a *Level 2 Offence* that is alleged to have been committed on the field of play during an *International Match*, then the *Report* must be lodged with the *Match Referee* (or, where, for logistical reasons, it is impractical to lodge with the *Match Referee*, the ICC's Cricket Operations Department) within eighteen hours of the close of the day's play in the relevant *International Match* or prior to the start of the following day's play or the start of the next relevant *International Match*, whichever is the sooner; or
 - 3.2.1.2 a *Level 1 Offence* or a *Level 2 Offence* that is alleged to have been committed at any time or place other than on the field of play then the *Report* must be lodged with the *Match Referee* (or, where, for logistical reasons, it is impractical to lodge with the *Match Referee*, the ICC's Cricket Operations Department) as soon as reasonably practicable, and in any event, no later than forty-eight (48) hours (where the *Report* is lodged by an *Umpire*) or ninety-six (96) hours (where the *Report* is lodged by the *Team Manager* or CEO of either of the two *National Cricket Federations*) after: (a) the commission of the alleged offence; or (b) the alleged offence was brought to the attention of the person lodging the *Report*; or
 - 3.2.1.3 a *Level 3 Offence* or a *Level 4 Offence* that is alleged to have been committed, then the *Report* must be lodged with the ICC's *Head of Legal* as soon as reasonably practicable, and in any event no later than seven (7) days after either: (a) the commission of the alleged offence; or (b) the alleged offence was brought to the attention of the person lodging the *Report*.
- 3.2.2 Where the *Report* is lodged by the individual described in Article 3.1.3 in relation to:
- 3.2.2.1 a *Level 1 Offence* or a *Level 2 Offence* that is alleged to have been committed at any time or place (whether on the field of play or otherwise), then the *Report* must be lodged with the *Match Referee* (or, where, for logistical reasons, it is impractical to lodge with the *Match Referee*, the ICC's Cricket Operations Department) within five (5) days of the commission of the alleged offence; or
 - 3.2.2.2 a *Level 3 Offence* or a *Level 4 Offence* that is alleged to have been committed at any time or place (whether on the field of play or otherwise), then the *Report* must be lodged with the ICC's *Head of Legal* as soon as reasonably practicable, and in any event no later than seven (7) days after: (a) the commission of the alleged offence; or (b) the alleged offence was brought to the attention of the ICC's *Chief Executive Officer*.
- 3.2.3 Where the *Report* is lodged by the individual described in Article 3.1.4 in relation to a *Level 3 Offence* or a *Level 4 Offence* that is alleged to have been committed, then the *Report* must be lodged with the ICC's *Head of Legal* as soon as reasonably practicable, and in any event no later than seven (7) days after: (a) the commission of the alleged offence; or (b) the alleged offence was brought to the attention of the *Match Referee*.

- 3.3 Where it is alleged that a *Player* or *Player Support Personnel* has committed more than one offence under the *Code of Conduct* during, or in relation to an *International Match* (whether arising out of the same set of facts or otherwise), then a separate *Report* should be filed in accordance with this Article 3 for each of the offences that are alleged to have been committed.

ARTICLE 4 - NOTIFICATION PROCEDURE

Level 1 Offences, Level 2 Offences and Minimum Over Rate Offences:

- 4.1 Where a *Match Referee* receives a *Report* lodged under Articles 3.2.1.1, 3.2.1.2, 3.2.2.1 or Article 3.2 of Appendix 2 (in the case of *Minimum Over Rate Offences*), he/she must promptly provide a copy of the *Report*, together with a completed Form 'Not 1', (such documents comprising the '**Notice of Charge**'), to the following individuals:
- 4.1.1 the *Player* or *Player Support Personnel* named in the *Report*, or, where appropriate in the case of an offence under either Article 2.2.9 (changing the condition of the ball), 2.2.10 (manipulating an *International Match*), or 2.5.1/2.5.2 (failure to meet the *Minimum Over Rate*), the relevant *Team Captain*; and
 - 4.1.2 the *Team Manager* of the relevant *Player* or *Player Support Personnel* named in the *Report*.
- 4.2 The *Notice of Charge* shall specify that the *Player* or *Player Support Personnel* shall have the following three options:
- 4.2.1 he/she may admit the offence charged and accede to the proposed sanction specified in the *Notice of Charge* (which sanction shall be strictly at the *Match Referee's* discretion, but at all times within the appropriate range for the level of offence). In such circumstances, and provided that such admission has been received by the *Match Referee* prior to the commencement of the hearing at the time/place specified in the *Notice of Charge*, the hearing before the *Match Referee* shall not be required and no further action shall be taken, save that the *ICC* shall promptly issue a public statement confirming: (a) the commission of an offence under the *Code of Conduct*; and (b) the imposition of the applicable sanction specified in the *Notice of Charge*; or
 - 4.2.2 he/she may admit the offence charged but dispute the proposed sanction specified in the *Notice of Charge*, in which case the matter shall proceed to a hearing in accordance with Article 5.1; or
 - 4.2.3 he/she may deny the offence charged, in which case the matter shall proceed to a hearing in accordance with Article 5.1.

Level 3 Offences and Level 4 Offences:

- 4.3 Where the *ICC's Head of Legal* receives a *Report* lodged under Articles 3.2.1.3, 3.2.2.2 or 3.2.3, he/she must promptly conduct a review to determine whether the *Player* or *Player Support Personnel* named in the *Report* has a case to answer.
- 4.4 If the initial review of the *Report* reveals that there is no case to answer, then the *ICC* shall notify the person who filed the *Report* of that fact, and the matter shall not proceed any further.
- 4.5 If the initial review of the *Report* reveals that there is a case to answer, then the *ICC* shall promptly provide a copy of the *Report*, together with a completed Form 'Not 1' (such documents comprising the '**Notice of Charge**') to the following individuals:

- 4.5.1 the *Player* or *Player Support Personnel* named in the *Report*; and
 - 4.5.2 the *Team Manager* of the relevant *Player* or *Player Support Personnel* named in the *Report*; and
 - 4.5.3 the CEO of the *National Cricket Federation* to which the relevant *Player* or *Player Support Personnel* is affiliated.
- 4.6 The *Notice of Charge* shall specify that the *Player* or *Player Support Personnel* shall have the following options:
- 4.6.1 he/she may admit the offence charged and accede to the proposed sanction specified in the *Notice of Charge* (which sanction shall be strictly at the ICC's discretion, but at all times within the appropriate range for the level of offence). In such circumstances, and provided that such admission has been received by the ICC's *Head of Legal* prior to the commencement of the hearing at the time/place specified in the *Notice of Charge*, the hearing before the *Judicial Commissioner* shall not be required and no further action shall be taken, save that the ICC shall promptly issue a public statement confirming: (a) the commission of an offence under the *Code of Conduct*; and (b) the imposition of the applicable sanction specified in the *Notice of Charge*; or
 - 4.6.2 he/she may admit the offence charged but dispute the proposed sanction specified in the *Notice of Charge*, in which case the matter shall proceed to a hearing in accordance with Article 5.2; or
 - 4.6.3 he/she may deny the offence charged, in which case the matter shall proceed to a hearing in accordance with Article 5.2.

ARTICLE 5 - THE DISCIPLINARY PROCEDURE

NOTE: Where a *Match Referee* appointed to adjudicate any matter brought under this Code of Conduct is not physically present at the relevant *International Match* (and therefore required to perform his/her duties remotely) then all hearings arising under Article 5.1 will be held by telephone conference or video conference (if available) and the provisions of Article 5.1 are to be interpreted accordingly.

Level 1 Offences, Level 2 Offences and Minimum Over Rate Offences:

- 5.1 Where a matter proceeds to a hearing under Article 4.2.2 or 4.2.3, then the case shall be referred to the *Match Referee* for adjudication in accordance with the following procedure:
- 5.1.1 Subject to the discretion of the *Match Referee* to order otherwise for good cause shown by the *Player* or *Player Support Personnel*, the hearing will take place at the time specified in the *Notice of Charge* (which should, in the absence of exceptional circumstances, be no more than thirty-six (36) hours after the receipt by the *Player* or *Player Support Personnel* of the *Notice of Charge*) and, subject to the note to Article 5, in the country in which the alleged offence was committed. For the avoidance of doubt, nothing in this Article
 - 5.1.1 prevents a hearing from being convened at a time during which the *International Match* in relation to which the alleged offence took place, remains in progress.
 - 5.1.2 The procedure followed at the hearing shall be at the discretion of the *Match Referee*, provided that the hearing is conducted in a manner which offers the *Player* or *Player Support Personnel* a fair and reasonable opportunity to present evidence (including the right to call and to question witnesses by telephone or video-conference where necessary), address the *Match Referee* and present his/her case.

- 5.1.3 The hearing before the *Match Referee* shall be in English, and certified English translations shall be submitted of any non-English documents put before the *Match Referee*. The cost of the translation shall be borne by the party offering the document(s).
- 5.1.4 Where video evidence of the alleged offence is available at the hearing before the *Match Referee*, then it may be relied upon by any party, provided that all other parties shall have the right to make such representations in relation to it that they may see fit.
- 5.1.5 Unless exceptional circumstances apply, each of the following individuals must attend any hearing before the *Match Referee*: (a) the *Player* or *Player Support Personnel* who has been charged with the alleged offence; and (b) the person who lodged the *Report* (or, in the case of the ICC's *Chief Executive Officer*, his/her representative/nominee). Where any such individual has a compelling justification for his/her non-attendance, then they shall be given the opportunity to participate in the hearing before the *Match Referee* by telephone or video conference (if available). Without prejudice to the *Player* or *Player Support Personnel's* ability to call and to question such witnesses as may be necessary and/or to be represented by such other person of his/her own choosing pursuant to Article 5.1.6, one of the *Team Captain*, *Team Vice-Captain* or *Team Manager* of the team that the *Player* or *Player Support Personnel* represents may also attend such a hearing to provide additional support and assistance to the *Player* or *Player Support Personnel*.
- 5.1.6 Each of the individuals described in Article 5.1.5(a) and (b) shall have the right (at his/her or its own expense) to be represented at the hearing before the *Match Referee* by such representative (including legal counsel) of his/her or its own choosing. Where the person lodging the *Report* is an *Umpire* that officiated in the *International Match* in question or the ICC's *Chief Executive Officer*, then such person shall be entitled to be represented prior to, and during, the hearing (if he/she considers necessary) by a representative of the ICC's Legal Department.
- 5.1.7 The non-attendance of any *Player* or *Player Support Personnel* or his/her representative at the hearing, shall not prevent the *Match Referee* from proceeding with the hearing in his/her absence and issuing a ruling in relation to the offence charged.
- 5.1.8 At the end of a hearing, where the *Match Referee* considers that further evidence is necessary or further time is required to consider the evidence that has been presented, he/she shall adjourn the hearing for an appropriate period of time and make such directions as may be necessary.
- 5.1.9 Alternatively, at the end of a hearing:
- 5.1.9.1 brought under Article 4.2.2:
- a) as soon as possible after the conclusion of the hearing (and, in any event, no later than forty-eight (48) hours thereafter), the *Match Referee* will confirm the *Player* or *Player Support Personnel's* admission that he/she had committed a *Code of Conduct* offence and announce his/her decision in writing, with reasons, setting out: (a) what sanctions, if any, are to be imposed (including any fine and/or period of suspension); (b) the date that any period of suspension shall come into force and effect; and (c) any rights of appeal that may exist pursuant to Article 8.

- 5.1.9.2 brought under Article 4.2.3 (or where the *Player* or *Player Support Personnel* has failed to respond in a timely fashion to the *Notice of Charge*):
- a) the *Match Referee* shall adjourn the hearing (for a period of no less than ten (10) minutes and no more than twenty-four (24) hours), following which he/she will reconvene the hearing and verbally announce his/her finding as to whether a *Code of Conduct* offence has been committed;
 - b) where the *Match Referee* determines that a *Code of Conduct* offence has been committed, the *Player* or *Player Support Personnel* may request a short adjournment (of no more than thirty (30) minutes) to prepare any submissions that he/she might wish to make in relation to the appropriate sanction that ought to be applied; and
 - c) as soon as possible after the conclusion of the hearing (and, in any event, no later than forty-eight (48) hours thereafter), the *Match Referee* will announce his/her decision in writing, with reasons, setting out: (a) the finding as to whether a *Code of Conduct* offence had been committed; (b) what sanctions, if any, are to be imposed (including any fine and/or period of suspension); (c) the date that any period of suspension shall come into force and effect; and (d) any rights of appeal that may exist pursuant to Article 8.
- 5.1.10 The *Match Referee* shall have the discretion to announce the substance of his/her decision prior to the issue of the written reasoned decision referred to in Article 5.1.9.
- 5.1.11 A copy of the written reasoned decision will be provided to the *Player* or *Player Support Personnel*, the CEO of the *Player* or *Player Support Personnel's National Cricket Federation*, and the ICC's *Cricket Operations Manager*.
- 5.1.12 Subject only to the rights of appeal under Article 8, the *Match Referee's* decision shall be the full, final and complete disposition of the matter and will be binding on all parties.

Level 3 Offences and Level 4 Offences:

- 5.2 Where a matter proceeds to a hearing under Article 4.6.2 or 4.6.3, then the case shall be referred to a *Judicial Commissioner* for adjudication in accordance with the following procedure:
- 5.2.1 As soon as reasonably possible, the ICC shall appoint one member from the ICC's *Code of Conduct Commission* to sit as the *Judicial Commissioner* to hear the case sitting alone. The appointed member shall be independent of the parties, have had no prior involvement with the case and shall not, unless otherwise agreed between the parties, be from a country participating in the *International Match*, during, or in relation to which, the alleged offence was committed.
 - 5.2.2 The *Judicial Commissioner* shall convene a preliminary hearing with the ICC and its legal representatives, together with the *Player* or *Player Support Personnel* and his/her legal representatives (if any). The preliminary hearing should take place as soon as possible by telephone conference call unless the *Judicial Commissioner* determines otherwise. The non-participation, without compelling justification, of the *Player*

or *Player Support Personnel* or his/her representative at the preliminary hearing, after proper notice of the preliminary hearing has been provided, shall not prevent the *Judicial Commissioner* from proceeding with the preliminary hearing, whether or not any written submissions are made on behalf of the *Player* or *Player Support Personnel*.

- 5.2.3 The purpose of the preliminary hearing shall be to allow the *Judicial Commissioner* to address any preliminary issues that need to be resolved prior to the hearing date. In particular (but without limitation), the *Judicial Commissioner* shall:
- 5.2.3.1 determine the date(s) upon which the full hearing shall be held. Save in exceptional circumstances or where the parties otherwise agree, the full hearing should take place no longer than fourteen (14) days after the receipt by the *Player* or *Player Support Personnel* of the *Notice of Charge*.
 - 5.2.3.2 establish dates reasonably in advance of the date of the full hearing by which:
 - a) the *ICC* shall submit an opening brief with argument on all issues that the *ICC* wishes to raise at the hearing and a list of the witnesses that the *ICC* intends to call at the hearing (and a summary of the subject areas of the witness's anticipated testimony), and enclosing copies of the exhibits that the *ICC* intends to introduce at the hearing;
 - b) the *Player* or *Player Support Personnel* shall submit an answering brief, addressing the *ICC*'s arguments and setting out argument on the issues that he/she wishes to raise at the hearing, as well as a list of the witnesses that he/she intends to call at the hearing (and a summary of the subject areas of the witness's anticipated testimony), and enclosing copies of the exhibits that he/she intends to introduce at the hearing; and
 - c) the *ICC* may (at its discretion) submit a reply brief, responding to the answer brief of the *Player* or *Player Support Personnel* and listing any rebuttal witnesses that the *ICC* intends to call at the hearing (and a summary of the subject areas of the witness's anticipated testimony), and enclosing copies of any other exhibits that the *ICC* intends to introduce at the hearing; and
 - 5.2.3.3 make such order as the *Judicial Commissioner* shall deem appropriate in relation to the production of relevant documents and/or other materials between the parties.
- 5.2.4 Subject to the discretion of the *Judicial Commissioner* to order otherwise for good cause shown by either party, or if otherwise agreed between the parties, hearings before the *Judicial Commissioner* shall take place in the country in which the alleged offence was committed.
- 5.2.5 The procedure followed at the hearing shall be at the discretion of the *Judicial Commissioner*, provided that the hearing is conducted in a manner which offers the *Player* or *Player Support Personnel* a fair and reasonable opportunity to present evidence (including the right to call and to question witnesses by telephone or video-conference where necessary), address the *Judicial Commissioner* and present his/her case.

- 5.2.6 The hearing before the *Judicial Commissioner* shall be in English, and certified English translations shall be submitted of any non-English documents put before the *Judicial Commissioner*. The cost of the translation shall be borne by the party offering the document(s). If required by the *Judicial Commissioner* (at his/her discretion), the ICC shall make arrangements to have the hearing recorded or transcribed. If requested by the *Player* or *Player Support Personnel*, the ICC shall also arrange for an interpreter to attend the hearing. Such costs of transcription and interpretation shall be paid by the ICC.
- 5.2.7 Where video evidence of the alleged offence is available at the hearing before the *Judicial Commissioner*, then it may be relied upon by any party, provided that all other parties shall have the right to make such representations in relation to it that they may see fit.
- 5.2.8 Unless exceptional circumstances apply, each of the following individuals must attend any hearing before the *Judicial Commissioner*: (a) the *Player* or *Player Support Personnel* who has been charged with the alleged offence; (b) the person who lodged the *Report* (or, in the case of the ICC's *Chief Executive Officer*, his/her representative/nominee); and (c) a representative of the ICC's Legal Department. Where any such individual has a compelling justification for his/her non-attendance, then they shall be given the opportunity to participate in the hearing before the *Judicial Commissioner* by telephone or video conference (if available). Without prejudice to the *Player* or *Player Support Personnel*'s ability to call and to question such witnesses as may be necessary and/or to be represented by such other person of his/her own choosing pursuant to Article 5.2.9, one of the *Team Captain*, *Team Vice-Captain* or *Team Manager* of the team that the *Player* or *Player Support Personnel* represents may also attend such hearing to provide additional support and assistance to the *Player* or *Player Support Personnel*.
- 5.2.9 Each of the individuals described in Article 5.2.8(a) and (b) shall have the right (at his/her or its own expense) to be represented at the hearing before the *Judicial Commissioner* by such representative (including legal counsel) of his/her or its own choosing. Where the person lodging the *Report* is an *Umpire* or *Match Referee* that officiated in the *International Match* in question or the ICC's *Chief Executive Officer*, then such person shall be entitled to be represented prior to, and during, the hearing (if he/she considers necessary) by a representative of the ICC's Legal Department.
- 5.2.10 The non-attendance of the *Player* or *Player Support Personnel* or his/her representative at the hearing, after proper notice of the hearing has been provided, shall not prevent the *Judicial Commissioner* from proceeding with the hearing in his/her absence, whether or not any written submissions are made on his/her behalf.
- 5.2.11 At the end of a hearing, where the *Judicial Commissioner* considers that further evidence is necessary or further time is required to consider the evidence that has been presented, he/she shall adjourn the hearing for an appropriate period of time and make such directions as may be necessary.

5.2.12 Alternatively, at the end of a hearing:

5.2.12.1 brought under Article 4.6.2:

- a) as soon as possible after the conclusion of the hearing (and, in any event, no later than forty-eight (48) hours thereafter), the *Judicial Commissioner* will confirm the *Player* or *Player Support Personnel's* admission that he/she had committed a *Code of Conduct* offence and announce his/her decision in writing, with reasons, setting out: (a) what sanctions, if any, are to be imposed (including any fine and/or period of suspension); (b) the date that any period of suspension shall come into force and effect; and (c) any rights of appeal that may exist pursuant to Article 8.

5.2.12.2 brought under Article 4.6.3 (or where the *Player* or *Player Support Personnel* has failed to respond in a timely fashion to the *Notice of Charge*):

- a) the *Judicial Commissioner* shall adjourn the hearing (for a period of no less than ten (10) minutes and no more than twenty-four (24) hours), following which he/she will reconvene the hearing and verbally announce his/her finding as to whether a *Code of Conduct* offence has been committed;
- b) where the *Judicial Commissioner* determines that a *Code of Conduct* offence has been committed, the *Player* or *Player Support Personnel* may request a short adjournment (of no more than thirty (30) minutes) to prepare any submissions that he/she might wish to make in relation to the appropriate sanction that ought to be applied; and
- c) as soon as possible after the conclusion of the hearing (and, in any event, no later than forty-eight (48) hours thereafter), the *Judicial Commissioner* will announce his/her decision in writing, with reasons, setting out: (a) the finding as to whether a *Code of Conduct* offence had been committed; (b) what sanctions, if any, are to be imposed (including any fine and/or period of suspension); (c) the date that any period of suspension shall come into force and effect; and (d) any rights of appeal that may exist pursuant to Article 8.

5.2.13 The *Judicial Commissioner* shall have the discretion to announce the substance of his/her decision prior to the issue of the written reasoned decision referred to in Article 5.2.12.

5.2.14 A copy of the written reasoned decision will be provided to the *Player* or *Player Support Personnel*, the CEO of the *Player* or *Player Support Personnel's National Cricket Federation*, and the ICC's *Cricket Operations Manager*.

5.2.15 Subject only to the rights of appeal under Article 8, the *Judicial Commissioner's* decision shall be the full, final and complete disposition of the matter and will be binding on all parties.

General Principles of Procedure

- 5.3 Where a *Report* is filed by more than one of the individuals described in Article 3.2 in relation to the same alleged offence under the *Code of Conduct*, then the *Player* or *Player Support Personnel* alleged to have committed the offence will only be served with one *Notice of Charge* in accordance with the procedures set out in Article 4. However, all persons who filed a *Report* (or, in the case of the ICC's *Chief Executive Officer*, his/her representative/nominee) in relation to the alleged offence are required to attend the hearing before the *Match Referee* or *Judicial Commissioner* unless there is a compelling justification for his/her non-attendance, in which case they shall be given the opportunity to participate in the hearing by telephone or video conference (if available).
- 5.4 Where two or more *Players* or *Player Support Personnel* are alleged to have committed offences under the *Code of Conduct*, they may both be dealt with at the same hearing where the proceedings arise out of the same incident or set of facts, or where there is a clear link between separate incidents, provided that the *Code of Conduct* permits the alleged offences to be determined by the same adjudicator. For the avoidance of doubt:
- 5.4.1 any number of *Level 1 Offences* and/or *Level 2 Offences* can all be determined by a *Match Referee* at the same hearing; and
 - 5.4.2 any number of *Level 3 Offences* and/or *Level 4 Offences* can all be determined by a *Judicial Commissioner* at the same hearing; but
 - 5.4.3 a *Level 1 Offence* or *Level 2 Offence* cannot be determined at the same hearing as a *Level 3 Offence* or a *Level 4 Offence* (and vice versa), and separate proceedings should therefore be issued in relation to each alleged offence.
- 5.5 Where a *Player* or *Player Support Personnel* is alleged to have committed more than one breach of the *Code of Conduct* during, or in relation to the same *International Match*, then all of the alleged offences may be dealt with at the same hearing, provided that the *Code of Conduct* permits the offences that are alleged to have been committed to be determined by the same adjudicator. For the avoidance of doubt:
- 5.5.1 any number of *Level 1 Offences* and/or *Level 2 Offences* can all be determined by a *Match Referee* at the same hearing; and
 - 5.5.2 any number of *Level 3 Offences* and/or *Level 4 Offences* can all be determined by a *Judicial Commissioner* at the same hearing; but
 - 5.5.3 a *Level 1 Offence* or *Level 2 Offence* cannot be determined at the same hearing as a *Level 3 Offence* or a *Level 4 Offence*, and separate proceedings should therefore be issued in relation to each alleged offence.
- 5.6 Any failure or refusal by any *Player* or *Player Support Personnel* to provide assistance to a *Match Referee* or *Judicial Commissioner* in connection with any charge made pursuant to this *Code of Conduct* may constitute a separate offence (depending upon the seriousness and context of such failure or refusal) under Articles 2.1.8, 2.2.12, 2.3.3 or 2.4.3 of the *Code of Conduct*.

- 5.7 Where a *Match Referee* is, or becomes unwilling or unable to hear a case (for example, where he/she finds him/herself in a position of conflict), then the ICC's *Head of Legal* shall have the discretion to appoint the ICC's *Chief Referee* or such other referee as the ICC deems to be appropriate in all the circumstances. Where the ICC's *Chief Referee* (or such other referee) is unwilling or unable to hear the case, a member of the ICC's *Code of Conduct Commission* (who shall have had no prior involvement with the case and shall not, unless otherwise agreed between the parties, be from a country participating in the *International Match* during, or in relation to which, the alleged offence was committed) as a replacement to the *Match Referee* and all of the remaining procedure will apply accordingly.
- 5.8 Where a *Judicial Commissioner* is, or becomes unwilling or unable to hear a case (for example, where he/she finds him/herself in a position of conflict), then the ICC's *Head of Legal* shall have the discretion to appoint another member of the ICC's *Code of Conduct Commission* (who shall have had no prior involvement with the case and shall not, unless otherwise agreed between the parties, be from a country participating in the *International Match* during, or in relation to which, the alleged offence was committed) as a replacement to the *Judicial Commissioner* and all of the remaining procedure will apply accordingly.
- 5.9 The ICC will issue a public announcement regarding any decision of the *Match Referee* or *Judicial Commissioner* made under the *Code of Conduct*, as soon as is reasonably practicable after the decision has been communicated to the parties. The public announcement of the decision may include details of the offences committed under the *Code of Conduct* and of the sanctions imposed, if any. Until such time as a public announcement is published, all parties and participants in the proceedings shall treat such proceedings as strictly confidential. For the avoidance of doubt, nothing in this Article shall prevent any party (or any relevant *National Cricket Federation*) publicly confirming the date of the hearing, the offence that is alleged to have been committed and/or the name of the *Player* or *Player Support Personnel* charged.

ARTICLE 6 - STANDARD OF PROOF AND EVIDENCE

- 6.1 Unless otherwise described herein, the standard of proof in all cases brought under the *Code of Conduct* shall be whether the *Match Referee* or *Judicial Commissioner* is comfortably satisfied, bearing in mind the seriousness of the allegation that is made, that the alleged offence has been committed. This standard of proof in all cases shall be determined on a sliding scale from, at a minimum, a mere balance of probability (for the least serious offences) up to proof beyond a reasonable doubt (for the most serious offences).
- 6.2 The *Match Referee* or *Judicial Commissioner* shall not be bound by judicial rules governing the admissibility of evidence. Instead, facts relating to an offence committed under the *Code of Conduct* may be established by any reliable means, including admissions.
- 6.3 The *Match Referee* or *Judicial Commissioner* may draw an inference adverse to the *Player* or *Player Support Personnel* who is asserted to have committed an offence under the *Code of Conduct* based on his/her refusal, without compelling justification, after a request made in a reasonable time in advance of the hearing, to appear at the hearing (either in person or telephonically as directed by the *Match Referee* or *Judicial Commissioner*) and/or to answer any relevant questions.

ARTICLE 7 - SANCTIONS ON PLAYERS AND PLAYER SUPPORT PERSONNEL

- 7.1 Where a *Match Referee* or *Judicial Commissioner* determines that an offence under the *Code of Conduct* has been committed, he/she will be required to impose an appropriate sanction on the *Player* or *Player Support Personnel*.
- 7.2 In order to determine the sanction that is to be imposed in each case, the *Match Referee* or *Judicial Commissioner* must first consider whether the *Player* or *Player Support Personnel* has previously been found guilty of an offence under the same Article of the *Code of Conduct* (or any predecessor regulations that may have applied) within a period of twelve months prior to the date on which the alleged offence took place.
- 7.3 Once the *Match Referee* or *Judicial Commissioner* has established whether this is a repeat offence within the relevant twelve month period, then he/she shall go on to take into account any other factors that he/she deems relevant and appropriate to the mitigation or aggravation of the nature of the *Code of Conduct* offence (including, without limitation, the nature and frequency of any previous offences under the *Code of Conduct*) before determining, in accordance with the following table, what the appropriate sanction(s) should be:

LEVEL OF OFFENCE	RANGE OF PERMISSIBLE SANCTIONS (FIRST OFFENCE)	RANGE OF PERMISSIBLE SANCTIONS (SECOND OFFENCE WITHIN 12 MONTHS)	RANGE OF PERMISSIBLE SANCTIONS (THIRD OFFENCE WITHIN 12 MONTHS)	RANGE OF PERMISSIBLE SANCTIONS (FOURTH AND SUBSEQUENT OFFENCES WITHIN 12 MONTHS)
Level 1	Warning/reprimand and/or the imposition of a fine of up to 50% of the applicable <i>Match Fee</i> .	The imposition of a fine of between 50-100% of the applicable <i>Match Fee</i> and/or up to two (2) <i>Suspension Points</i> .	The imposition of between two (2) and eight (8) <i>Suspension Points</i> .*	The imposition of eight (8) <i>Suspension Points</i> or a suspension for a fixed period of time ranging between the equivalent of eight (8) <i>Suspension Points</i> and one (1) year.*
Level 2	The imposition of a fine of between 50-100% of applicable <i>Match Fee</i> and/or up to two (2) <i>Suspension Points</i> .	The imposition of between two (2) and eight (8) <i>Suspension Points</i> .*	The imposition of eight (8) <i>Suspension Points</i> or a suspension for a fixed period of time ranging between the equivalent of eight (8) <i>Suspension Points</i> and one (1) year.*	The imposition of a suspension of between one (1) and five (5) years.
Level 3	The imposition of between four (4) and eight (8) <i>Suspension Points</i> .*	The imposition of eight (8) <i>Suspension Points</i> or a suspension for a fixed period of time ranging between the equivalent of eight (8) <i>Suspension Points</i> and one (1) year.*	The imposition of a suspension between one (1) year and a lifetime.	n/a
Level 4	The imposition of eight (8) <i>Suspension Points</i> or a suspension for a fixed period of time ranging between, at a minimum, the lesser of the equivalent of eight (8) <i>Suspension Points</i> and one (1) year, up to a maximum of a lifetime's suspension.	The imposition of a suspension of between one (1) year and a lifetime.	n/a	n/a
Minimum Over Rate Offences	See specific sanctions described in the table at Article 4 of Appendix 2.			

***NOTE:** In all cases marked with a *, the maximum 'actual' period of suspension shall be no more than one (1) year, irrespective of the number and/or the practical application of any *Suspension Points* that might be imposed.

- 7.4 Where a *Match Referee* or *Judicial Commissioner* imposes a period of suspension on any *Player* or *Player Support Personnel*, then, unless such period is for a fixed period of time (for example, one year) then, any such period of suspension shall be referenced by *Suspension Points*, which shall carry the following weightings:
- 7.4.1 a *Test Match* or any other *International Match* of at least four days in duration is given a weighting of two (2) *Suspension Points*;
 - 7.4.2 a *One Day International Match* or *Twenty20 International Match* is given a weighting of one (1) *Suspension Point*; and
 - 7.4.3 all other *International Matches* are given a weighting of one (1) *Suspension Point*.
- 7.5 Where *Suspension Points* are imposed against a *Player* or *Player Support Personnel*, then such *Suspension Points* will be applied in accordance with the following principles:
- 7.5.1 the *Match Referee* or *Judicial Commissioner* shall have regard to the *Player's* or *Player Support Personnel's* participation in the various formats of *International Matches* over the previous two years in order to determine (to the best of his/her ability) which of the forthcoming *International Matches* the *Player* is most likely to participate in or the *Player Support Personnel* is most likely to assist the participation of a *Player* in;
 - 7.5.2 where necessary, the *Match Referee* or *Judicial Commissioner* shall be entitled to consult with the *ICC* in order to make a determination as to which of the forthcoming *International Matches* the *Player* is most likely to participate in or the *Player Support Personnel* is most likely to assist the participation of a *Player* in;
 - 7.5.3 in so far as is reasonably possible, the *Match Referee* or *Judicial Commissioner* shall apply the *Suspension Points* to the subsequent *International Matches* in which the *Player* is most likely to participate in or the *Player Support Personnel* is most likely to assist the participation of a *Player* in, on a chronological basis immediately following the announcement of the decision;
 - 7.5.4 where a *Player* or *Player Support Personnel* has his/her *Suspension Points* applied to an *International Match* that is subsequently cancelled, postponed or otherwise abandoned prior to the actual day on which it is scheduled to take place, then such *Suspension Points* must be reallocated to the next subsequent *International Matches* in which the *Player* is most likely to participate in or the *Player Support Personnel* is most likely to assist the participation of a *Player* in. Where an *International Match* is cancelled, postponed or otherwise abandoned at any time on the actual day on which it is scheduled to take place, then the *Suspension Points* will remain allocated to that *International Match*, irrespective of such cancellation, postponement or abandonment.

Examples of the Application of Suspension Points:

- 1 Where a Player's playing history suggests that he/she is most likely to represent his National Cricket Federation in Test Matches only, then the Suspension Points shall be applied to his/her future participation in Test Matches only, so that six (6) Suspension Points would be applied to the three (3) Test Matches immediately following the announcement of the decision, notwithstanding that the National Cricket Federation might be participating in intervening One Day International Matches and/or Twenty20 International Matches.
- 2 Where a Player's playing history suggests that he/she is likely to be selected to represent his National Cricket Federation in all formats of International Matches, then the Suspension Points shall be applied to his/her future participation in all International Matches in the sequential order in which such International Matches take place immediately following the announcement of the decision. The examples set out below, would apply to the following chronological list of potential playing fixtures:
 - Code of Conduct decision
 - One-Day International Match - weighting 1 Suspension Point ('Match A')
 - One-Day International Match - weighting 1 Suspension Point ('Match B')
 - Test Match - weighting 2 Suspension Point ('Match C')
 - Test Match weighting 2 Suspension Point ('Match D')
 - Twenty20 International Match - weighting 1 Suspension Point ('Match E')
 - Twenty20 International Match - weighting 1 Suspension Point ('Match F')
 - a) One (1) Suspension Point would be applied to Match A;
 - b) Two (2) Suspension Points would be applied to Matches A and B;
 - c) Three (3) Suspension Points would be applied to Matches A, B and E;
 - d) Four (4) Suspension Point would be applied to Match A, B and C;
 - e) Five (5) Suspension Points would be applied to Matches A, B, C and E;
 - f) Six (6) Suspension Points would be applied to Matches A, B, C and D;
 - g) Seven (7) Suspension Points would be applied to Matches A, B, C, D and E;
 - h) Eight (8) Suspension Points would be applied to Matches A, B, C, D, E and F.

7.6 For the avoidance of any doubt:

- 7.6.1 the Match Referee or Judicial Commissioner will have no jurisdiction to adjust, reverse or amend the results of any International Match;
- 7.6.2 where a Player or Player Support Personnel is found guilty of committing two separate Code of Conduct offences that do not relate to the same incident or set of circumstances arising during an International Match and sanctioned separately for each offence, then any sanctions should run cumulatively (and not concurrently);

- 7.6.3 where a *Player* or *Player Support Personnel* is found guilty of committing two *Code of Conduct* offences in relation to the same incident or set of circumstances arising during an *International Match* and sanctioned separately, then any sanctions imposed should run concurrently (and not cumulatively);
- 7.6.4 nothing in this *Code of Conduct* shall permit plea bargaining in relation to any alleged offence committed under this *Code of Conduct*;
- 7.6.5 where the *Match Referee* or *Judicial Commissioner* finds a *Player* or *Player Support Personnel* not guilty of the offence allegedly committed under the *Code of Conduct*, then it remains open to him/her, at his/her discretion, to find the *Player* or *Player Support Personnel* guilty of an offence of a lower level than that with which he/she has been charged. For example where a *Player* or *Player Support Personnel* has been charged with (but been found not guilty of) the *Level 2 Offence* of 'showing serious dissent at an *Umpire's* decision' (Article 2.2.1), the *Match Referee* may, instead, find the *Player* or *Player Support Personnel* guilty of the *Level 1 Offence* of 'showing dissent at an *Umpire's* decision' (Article 2.1.3) and impose an appropriate sanction; and
- 7.6.6 where a fine and/or costs award is imposed against a *Player* or *Player Support Personnel*, then such fine and/or costs award must be paid: (a) by the *Player* or *Player Support Personnel* (and not any other third party, including a *National Cricket Federation*); (b) to the *Player* or *Player Support Personnel's National Cricket Federation* (for onward transmission to the *ICC*) within one calendar month of receipt of the decision imposing the fine. However, the *ICC* will consider any request from any *Player* or *Player Support Personnel* to make the payment of such fines and/or costs over a prolonged period of time on the grounds of financial hardship. Should any fine and/or costs award (or agreed part-payment or instalment thereof) not be paid to the relevant *National Cricket Federation* within such deadline or by the time of the next agreed payment date, the *Player* or *Player Support Personnel* may not play, coach or otherwise participate or be involved in any capacity in any *International Match* until such payment has been satisfied in full.
- 7.7 Where a *Player* or *Player Support Personnel* has had *Suspension Points* imposed against him/her or has been suspended for a fixed period of time, he/she may not play, coach or otherwise participate or be involved in any capacity in the *International Match(es)* which: (a) are covered by the application of his/her *Suspension Points* as determined in accordance with Article 7.7; or (b) take place during the fixed period of his/her suspension.

NOTE: For the avoidance of any doubt, a *Player* or (where relevant) *Player Support Personnel* who has had *Suspension Points* imposed against him/her or has been suspended for a fixed period of time shall not, during the *International Matches* which are covered by his/her *Suspension Points* or the period of suspension:

- a) be nominated as, or carry out any of the duties or responsibilities of, a substitute fielder; or
- b) enter any part of the playing area (which shall include, for the avoidance of doubt, the field of play and the area between the boundary and perimeter boards) at any time, including during any scheduled or unscheduled breaks in play.

In addition, *Player Support Personnel* so sanctioned shall not be permitted to enter the *players' dressing room* (including the viewing areas) during any *International Match* covered by his/her *Suspension Points* or the period of suspension. *Players* so sanctioned will, however, be permitted to enter the *players' dressing room* provided that the *players' dressing room* (or any part thereof) for the relevant *International*

Match is not within the player area described in (b) above (for example, no such Player shall be permitted access to an on-field 'dug-out').

Finally, any Player or Player Support Personnel so sanctioned shall not be prevented from attending any post-match ceremonies or presentations taking place anywhere on the field of play or otherwise following the conclusion of an International Match covered by his/her Suspension Points or the period of suspension unless the suspension or Suspension Points have been imposed in respect of a Level 3 or Level 4 Offence under this Code of Conduct. In such circumstances, the Player or Player Support Personnel shall not be permitted to attend such ceremonies or presentations.

- 7.8** Once any *Suspension Points* or fixed period of suspension has expired, the *Player or Player Support Personnel* will automatically become re-eligible to participate (in the case of a *Player*) or assist the participation (in the case of a *Player Support Personnel*) in *International Matches* provided that he/she has paid, in full, all amounts forfeited under the *Code of Conduct*, including any fines, compensatory awards or award of costs that may have been imposed against him/her.

ARTICLE 8 - APPEALS

8.1 Appeals from decisions in relation to a first Level 1 Offence

- 8.1.1 Decisions made under the *Code of Conduct* by a *Match Referee* in relation to a first *Level 1 Offence* shall be non-appealable and shall remain the full and final decision in relation to the matter.

8.2 Appeals from decisions in relation to: (a) a second, third or fourth Level 1 Offence; (b) a Level 2 Offence; or (c) a Minimum Over Rate Offence

- 8.2.1 Decisions made under the *Code of Conduct* by a *Match Referee* in relation to: (a) a second, third or fourth *Level 1 Offence* within the applicable twelve month period; or (b) a *Level 2 Offence*; or (c) a *Minimum Over Rate Offence*, may be challenged solely by appeal as set out in this Article 8.2. Such decision shall remain in effect while under appeal unless any *Judicial Commissioner* properly convened to hear the appeal orders otherwise.
- 8.2.2 The only parties who may appeal a decision of this nature shall be: (a) the *Player or Player Support Personnel* found guilty of the offence or, where appropriate in the case of an offence under either Article 2.2.9 (changing the condition of the ball), 2.2.10 (manipulation of an *International Match*), or 2.5.1/2.5.2 (failure to meet the *Minimum Over Rate*), the relevant *Team Captain*; and (b) the *ICC's Chief Executive Officer* (or his/her designee).
- 8.2.3 Any notice to appeal under this Article must be lodged with the *ICC's Head of Legal* within 48 hours of receipt of the written decision of the *Match Referee*. In all cases, a copy of such notice will also be provided to the CEO of the *National Cricket Federation* to which the *Player or Player Support Personnel* is affiliated. Thereafter, the following will apply:
- 8.2.3.1 Within 48 hours of receipt of a notice to appeal: (a) the *ICC's Head of Legal* will appoint a member of the *ICC's Code of Conduct Commission* who is (unless otherwise agreed between the parties) from a country other than those participating in the *International Match* during, or in relation to which, the alleged offence was committed, to act as *Judicial Commissioner* and hear the appeal sitting alone; and (b) the *Match Referee* will provide a written statement to the *ICC's Head of Legal* setting out any relevant facts (to be copied to the *Player or Player Support Personnel*).

- 8.2.3.2 The *provisions* of Articles 5.1.2 to 5.1.11, applicable to proceedings before the *Match Referee*, shall apply *mutatis mutandis* (ie with changes deemed to have been made as required to reflect the different context) to appeal hearings before the *Judicial Commissioner*.
- 8.2.3.3 The *Judicial Commissioner* shall hear and determine all issues arising from any matter which is appealed pursuant to this Article on a *de novo* basis, ie he/she shall hear the matter over again, from the beginning, without being bound in any way by the decision being appealed. For the avoidance of doubt, the *Judicial Commissioner* shall have the power to increase or decrease, amend or otherwise substitute a new decision on the appropriateness (or otherwise) of the sanction imposed at first instance, provided that any new sanction must be within the permitted range of sanctions set out in the table in Article 7.3 (or, where applicable, Article 4 of Appendix 2).
- 8.2.3.4 Appeal hearings pursuant to this Article 8.2 should be completed expeditiously. Save where all parties agree or fairness requires otherwise, the appeal hearing shall be commenced no later than seven (7) days after the appointment of the member of the *Judicial Commissioner*.
- 8.2.3.5 The *Judicial Commissioner* shall have the power to order some or all of the costs of the appeal proceedings (including the costs of holding the hearing, any interpretation costs, the legal and/or travel/accommodation costs of the *Judicial Commissioner* and/or any other relevant parties) to be paid by the appealing party if he/she considers that such party has acted spuriously, frivolously or otherwise in bad faith.
- 8.2.3.6 Any decision made by the *Judicial Commissioner* under this Article 8.2, shall be the full, final and complete disposition of the matter and will be binding on all parties.

8.3 Appeals from decisions in relation to a **Level 3 Offence** or **Level 4 Offence**

- 8.3.1 Decisions made under the *Code of Conduct* by a *Judicial Commissioner* in relation to a **Level 3 Offence** or **Level 4 Offence** may be challenged solely by appeal as set out in this Article 8.3. Such decision shall remain in effect while under appeal unless any properly convened *Appeal Panel* orders otherwise.
- 8.3.2 The only parties who may appeal a decision made in relation to a **Level 3 Offence** or **Level 4 Offence** shall be: (a) the *Player* or *Player Support Personnel* found guilty of the offence; and (b) the *ICC's Chief Executive Officer*.
- 8.3.3 Any notice to appeal under this Article must be lodged with the *ICC's Head of Legal* within seven (7) days of receipt of the written decision of the *Judicial Commissioner*. In all cases, a copy of such notice will also be provided to the CEO of the *National Cricket Federation* to which the *Player* or *Player Support Personnel* is affiliated. Thereafter, the following will apply:
- 8.3.3.1 Within forty-eight (48) hours of receipt of a notice to appeal: (a) the *ICC's Head of Legal* will appoint three members of the *ICC's Code of Conduct Commission* each of whom are (unless otherwise agreed between the parties) from a country other than those participating in the relevant *International Match* to sit as the *Appeal Panel* to hear the appeal; and (b) the

Judicial Commissioner will provide a written statement to the *ICC's Head of Legal* setting out any relevant facts (to be copied to the *Player* or *Player Support Personnel*).

- 8.3.3.2 The provisions of Articles 5.2.2 to 5.2.14, applicable to proceedings before the *Judicial Commissioner*, shall apply *mutatis mutandis* (ie with changes deemed to have been made as required to reflect the different context) to appeal hearings before the *Appeal Panel*.
- 8.3.3.3 The *Appeal Panel* shall hear and determine all issues arising from any matter which is appealed to it pursuant to this Article on a *de novo* basis, ie it shall hear the matter over again, from the beginning, without being bound in any way by the decision being appealed. For the avoidance of doubt, the *Appeal Panel* shall have the power to increase or decrease, amend or otherwise substitute a new decision on the appropriateness (or otherwise) of the sanction imposed at first instance, provided that any new sanction must be within the permitted range of sanctions set out in the table in Article 7.3.
- 8.3.3.4 Appeal hearings pursuant to this Article 8.3 should be completed expeditiously. Save where all parties agree or fairness requires otherwise, the appeal hearing shall be commenced no later than thirty (30) days after the appointment of the *Appeal Panel*.
- 8.3.3.5 The *Appeal Panel* shall have the power to order some or all of the costs of the appeal proceedings (including the costs of holding the hearing, any interpretation costs, the legal and/or travel/accommodation costs of the *Appeal Panel* and/or any other relevant parties) to be paid by the appealing party if it considers that such party has acted, spuriously, frivolously or otherwise in bad faith.
- 8.3.3.6 Any decision made by the *Appeal Panel* under this Article 8.3, shall be the full, final and complete disposition of the matter and will be binding on all parties.

8.4 No appeal in relation to an accepted sanction

- 8.4.1 For the avoidance of doubt, where a *Player* or *Player Support Personnel* admits the offence charged and accedes to the proposed sanction specified in the *Notice of Charge* in accordance with the procedure described in Articles 4.2.1 or 4.6.1, the *Player* or *Player Support Personnel* waives his/her right to any appeal against the imposition of such a sanction.

ARTICLE 9 - RECOGNITION OF DECISIONS

- 9.1 Any hearing results or other final adjudications under the *Code of Conduct* shall be recognised and respected by the ICC and its *National Cricket Federations* automatically upon receipt of notice of the same, without the need for any further formality. Each of the ICC and its *National Cricket Federations* shall take all steps legally available to it to enforce and give effect to such decisions.
- 9.2 It shall be a condition of membership of the ICC that all *National Cricket Federations* shall comply with the *Code of Conduct*.

ARTICLE 10 - AMENDMENT AND INTERPRETATION OF THE CODE OF CONDUCT

- 10.1 The *Code of Conduct* may be amended from time to time by the Executive Board of the ICC, with such amendments coming into effect on the date specified by the ICC.
- 10.2 The headings used for the various Articles of the *Code of Conduct* are for the purpose of guidance only and shall not be deemed to be part of the substance of the *Code of Conduct* or to inform or affect in any way the language of the provisions to which they refer.
- 10.3 The *Code of Conduct* shall come into full force and effect on 1 October 2013 (the **Effective Date**). It shall not apply retrospectively to matters pending before the *Effective Date*; provided, however, that any case pending prior to the *Effective Date*, or brought after the *Effective Date* but based on an offence that is alleged to have occurred before the *Effective Date*, shall be governed by the predecessor version of the *Code of Conduct* in force at the time of the alleged offence, subject to any application of the principle of *lex mitior* by the hearing panel determining the case.
- 10.4 If any Article or provision of this *Code of Conduct* is held invalid, unenforceable or illegal for any reason, the *Code of Conduct* shall remain otherwise in full force apart from such Article or provision which shall be deemed deleted insofar as it is invalid, unenforceable or illegal.
- 10.5 The *Code of Conduct* is governed by and shall be construed in accordance with English law. Strictly without prejudice to the arbitration provisions of Articles 5 and 8 of the *Code of Conduct*, disputes relating to the *Code of Conduct* shall be subject to the exclusive jurisdiction of the English courts.

APPENDIX 1 - DEFINITIONS

Affiliate Member. Any National Cricket Federation with *affiliate member* status of the ICC.

Appeal Panel. A panel of three persons appointed by the ICC from the members of the ICC Code of Conduct Commission to perform the functions assigned to the Appeal Panel under the Code of Conduct. Each member of the Appeal Panel shall be independent of the ICC, which may provide reasonable compensation and reimbursement of expenses to such members.

Associate Member. Any National Cricket Federation with *associate member* status of the ICC.

Effective Date. As defined in Article 10.3.

Full Member. Any National Cricket Federation with *full member* status of the ICC.

ICC. The International Cricket Council or its designee.

ICC's Chief Executive Officer. The person appointed by the ICC from time to time to act as the ICC's Chief Executive Officer (or his/her designee).

ICC's Chief Referee. The person appointed by the ICC from time to time to act as the ICC's Chief Referee (or his/her designee).

ICC's Clothing and Equipment Regulations. The ICC's Clothing and Equipment Regulations, in force from time to time.

ICC Code of Conduct Commission. An official committee of the ICC established, amongst other things, to provide independent enquiries, investigations and rulings in relation to matters brought to its attention pursuant to the Code of Conduct. Each member of the ICC Code of Conduct Commission shall be independent of the ICC, which may provide reasonable compensation and reimbursement of expenses to such members.

ICC Code of Conduct for Umpires and Referees. The ICC's Code of Conduct for Umpires and Referees, in force from time to time.

ICC Events. Each of the following: (a) the ICC Cricket World Cup; (b) the ICC World Twenty20; (c) the ICC Champions Trophy; (d) the ICC World Cricket League Divisions 1-8 (inclusive), together with any regional qualifying events thereto; (e) the ICC Women's Cricket World Cup; (f) the ICC Under 19 Cricket World Cup; (g) the ICC World Cup Qualifying Tournament; (h) the ICC Women's Cricket World Cup Qualifying Tournament, together with any regional qualifying events thereto; (i) the ICC World Twenty20 Qualifying Tournament; (j) the ICC Under 19 Cricket World Cup Qualifying Tournament, together with any regional qualifying events thereto; (k) the ICC Intercontinental Cup and Shield; and (l) any other event organised or sanctioned by the ICC from time to time to which the ICC deems it appropriate that the Code of Conduct should apply.

ICC's Head of Legal. The person appointed by the ICC from time to time to act as the ICC's Head of Legal (or his/her designee).

ICC's Operating Manual. The ICC's Official Operating Manual in force from time to time.

International Match. Each of the following (in men's and women's cricket): (a) any Test Match, One Day International Match or Twenty20 International Match; (b) any Match played as part of an ICC Event; (c) any International Tour Match; or (d) any other Match organised or sanctioned by the ICC from time to time to which the ICC deems it appropriate that the Code of Conduct should apply.

International Tour Match. Any Match played between a representative team of a Full Member (or Associate Member with Test and/or ODI or T20I Status) and any domestic, guest or invitational team.

Judicial Commissioner. The independent person appointed by the ICC from the ICC Code of Conduct Commission, to perform the functions assigned to the Judicial Commissioner under the Code of Conduct.

Level 1 Offence. Any of the offences described in Articles 2.1.1 – 2.1.8.

Level 2 Offence. Any of the offences described in Articles 2.2.1 – 2.2.12.

Level 3 Offence. Any of the offences described in Articles 2.3.1 – 2.3.3.

Level 4 Offence. Any of the offences described in Articles 2.4.1 – 2.4.4.

Match. A cricket *match* of any format and duration in length played between representative teams (male or female) of two *National Cricket Federations* affiliated to the ICC.

Match Fee. The designated *match fee* (which is to be used for the purposes of calculating sanctions in accordance with Article 7) as set out in Appendix 3 of this *Code of Conduct*.

Match Referee. The independent person appointed by the ICC (or any other relevant party) as the official *match referee* for a designated *International Match*, whether such *Match Referee* carries out his/her functions remotely or otherwise. Where a *Match Referee* is not physically present at a particular *Match*, he/she may be assisted in the administrative performance of his/her duties under this *Code of Conduct* by any official 'Match Manager' who may be appointed to officiate at such *International Match*.

Minimum Over Rate. As defined in Appendix 2 of this *Code of Conduct*.

Minimum Over Rate Offence. Any of the offences described in Articles 2.5.1 – 2.5.2.

Minor Over Rate Offence. As defined in Article 2.5.1.

National Cricket Federation. A national or regional entity which is a member of or is recognised by the ICC as the entity governing the sport of cricket in a country (or collective group of countries associated for cricket purposes).

Notice of Charge. As defined in Article 4.1 and/or Article 4.5.

One Day International Match. As defined by Section 33 (*ICC Classification of Official Cricket*) of the ICC's *Operating Manual*.

Player. Any cricketer who is selected in any playing or touring team or squad that is chosen to represent a *National Cricket Federation* in any *International Match* or series of *International Matches*.

Player Support Personnel. Any coach, trainer, manager, selector, team official, doctor, physiotherapist or any other person employed by, representing or otherwise affiliated to a playing/touring team or squad that is chosen to represent a *National Cricket Federation* in any *International Match* or series of *International Matches*.

Report. As defined in Article 3.1.

Serious Over Rate Offence. As defined in Article 2.5.2.

Suspension Points. The weighting points used to determine the period of suspension imposed against any *Player* or *Player Support Personnel* pursuant to Article 7 of the *Code of Conduct*.

Team Captain or Vice Captain. The official captain or vice captain of any team participating in a *Match*.

Team Manager. The official manager of any team participating in a *Match*.

Test Match. As defined by Section 33 (*ICC Classification of Official Cricket*) of the ICC's *Operating Manual*.

Twenty20 International Match. As defined by Section 33 (*ICC Classification of Official Cricket*) of the ICC's *Operating Manual*.

Umpire. Any *umpire* (including any third or other *umpires*) appointed to officiate in a *Match*.

APPENDIX 2 – MINIMUM OVER RATE REQUIREMENTS, CALCULATION, REPORTING AND DISCIPLINARY PROCESS AND SANCTIONS

1 MINIMUM OVER RATE

The *minimum over rate* to be achieved by the fielding team in all *International Matches* shall be as set out in the playing conditions to the relevant *International Match* (the '**Minimum Over Rate**').

2 CALCULATING THE ACTUAL OVER RATE

- 2.1 The actual over rate will be calculated at the end of each *International Match* by those *Umpires* appointed to officiate in such *International Match*. In the case of *Test Matches* (or other *International Matches* of at least four days in duration), the actual over rate will be the average rate which is achieved by the fielding team across both of the batting team's innings.
- 2.2 In calculating the actual over rate for an *International Match*, allowances will be given for the actual time lost as a result of any of the following:
 - 2.2.1 treatment given to a *Player* by an authorised medical personnel on the field of play;
 - 2.2.2 a *Player* being required to leave the field as a result of a serious injury;
 - 2.2.3 all third *Umpire* referrals and consultations;
 - 2.2.4 time wasting by the batting side (which may, in addition, constitute a separate offence pursuant to any of Articles 2.1.8, 2.2.11, 2.3.3 or 2.4.4 depending upon the context and seriousness of the incident); and
 - 2.2.5 all other circumstance that are beyond the control of the fielding team.
- 2.3 In addition, the following time allowances will only be given in:
 - 2.3.1 *Test Matches* (or other *International Matches* of at least four days in duration):
 - a) 2 minutes per wicket taken, provided that such wicket results in the subsequent batsmen immediately commencing his innings. For the avoidance of any doubt, no time allowance will be given for the final wicket of an innings or where a wicket falls immediately prior to any interval; and
 - b) 4 minutes per drinks break taken (one per session).
 - 2.3.2 *Twenty20 International Matches*:
 - a) 1 minute for every 3 full overs that an innings is reduced by as a result of any delay and/or interruption in play.
- 2.4 Further, where the batting team:
 - 2.4.1 in a *Test Match* (or other *International Match* of at least four days in duration) is bowled out in 3½ hours or less (taking into account all of the time allowances described in this Article 2) in any particular innings, no account shall be taken of the actual over rate in that innings when calculating the actual over rate at the end of such *Match*.
 - 2.4.2 in an *One Day International Match* is bowled out within the time determined for that innings pursuant to the ICC's Standard ODI Playing Conditions, no sanction may be imposed in respect of a breach of the *Minimum Over Rate*.

3 PROCEDURE

- 3.1 Where the actual over rate is calculated by the *Umpires* as being equal to or in excess of the *Minimum Over Rate*, no further action shall be taken.
- 3.2 Where the actual over rate is calculated by the *Umpires* as being less than the *Minimum Over Rate*, the following shall apply:
- 3.2.1 only the *Umpires* that officiated in the *International Match* during which the alleged offence was committed can *report* such an offence to the *Match Referee*, and such *Report*, which must be completed on Form 'Rep 1' must be lodged with the *Match Referee* (or, where, for logistical reasons, it is impractical to lodge with the *Match Referee*, the ICC's Cricket Operations Department) within 18 hours of the close of the day's play in the relevant *International Match* or prior to the start of the following day's play, whichever is the sooner;
- 3.2.2 thereafter, the *Match Referee* shall promptly consult with the *Umpires* and shall be entitled, after such consultation, to make such amendments to the actual over rate calculation as he/she deems appropriate in the circumstances to reflect those circumstances that are beyond the control of the fielding team (including, but not limited to those set out in Article 2 of this Appendix 2).
- 3.2.3 where the *Match Referee* confirms that the *Minimum Over Rate* has not been achieved by the fielding side in any *International Match*, this shall constitute an offence under either Article 2.5.1 or 2.5.2 of the *Code of Conduct* and the *Match Referee* will promptly issue a *Notice of Charge* in accordance with Article 4.1 of the *Code of Conduct* (with the *Team Captain* being charged on behalf of the *Players* in the fielding side as well as him/herself) and the matter will be thereafter be adjudicated by the *Match Referee* in accordance with the procedure set out in Article 5.

4 APPLICABLE SANCTIONS FOR A MINIMUM OVER RATE OFFENCE

- 4.1 The principles set out in Article 7 (regarding sanctions) shall be applied in full except that:
- 4.1.1 in order to determine the sanction that is to be imposed in each case, the *Match Referee* must first consider whether the *Player* has previously been found guilty of the same offence under the *Code of Conduct* (or any predecessor regulations that may have applied) in the same format of the game within a period of twelve months prior to the date on which the alleged offence took place.
- 4.1.2 once the *Match Referee* has established whether or not this is a repeat offence in the same format of the game within the relevant twelve month period, then:
- 4.1.2.1 in the case of a *Minor Over Rate Offence*, (and subject to the qualifying guidance note below), he/she shall apply the mandatory sanctions that are set out in the table at Article 4.2, below; or
- 4.1.2.2 in the case of a *Serious Over Rate Offence*, he/she shall take into account any other factors that he/she deems relevant and appropriate to the mitigation or aggravation of the nature of the *Serious Over Rate Offence* before determining, in accordance with the table at Article 4.2, below, what the appropriate sanction(s) should be.

4.2 For the purposes of *Minimum Over Rate Offences* only, the table at Article 7.3 of the *Code of Conduct* shall be replaced with the following:

MINIMUM OVER RATE OFFENCE	INDIVIDUAL	RANGE OF PERMISSIBLE SANCTIONS (FIRST OFFENCE)	RANGE OF PERMISSIBLE SANCTIONS (SECOND OFFENCE IN THE SAME FORMAT OF THE GAME WITHIN 12 MONTHS)
Minor Over Rate Offence (Article 2.5.1)	Player	10% of Match Fee per over short of <i>Minimum Over Rate</i> .	
	Team Captain	20% of Match Fee per over short of <i>Minimum Over Rate</i>	20% of Match Fee per over short of <i>Minimum Over Rate</i> AND the imposition of a suspension for the immediately subsequent one (1) <i>International Match in the same format of the game</i> as that in which the offence occurred.

NOTE: For the avoidance of doubt, where a Team Captain whose team has already been found to have committed two Minor Over Rate Offences in the same format of the game within a period of twelve months, commits a further offence in the same format of the game in the same twelve month period, in determining the sanction to be imposed, the latest offence shall be treated as a first offence for the purposes of the table at Article 4.2 above.

MINIMUM OVER RATE OFFENCE	INDIVIDUAL	RANGE OF PERMISSIBLE SANCTIONS (FIRST OFFENCE)	RANGE OF PERMISSIBLE SANCTIONS (SECOND OFFENCE IN THE SAME FORMAT OF THE GAME WITHIN 12 MONTHS)	RANGE OF PERMISSIBLE SANCTIONS (THIRD OFFENCE IN THE SAME FORMAT OF THE GAME WITHIN 12 MONTHS)
Serious Over Rate Offence (Article 2.5.2)	Player	10% of Match Fee per over short of the <i>Minimum Over Rate</i> for the: (a) first five overs in a <i>Test Match</i> (or other <i>International Matches</i> of at least four days in duration); or (b) first two overs in any <i>One Day International Match</i> , <i>Twenty20 International Match</i> or any other <i>International Match</i> of fifty (50) or twenty (20) overs per side AND 20% of Match Fee per additional over short of the <i>Minimum Over Rate</i> .		
	Team Captain	The imposition of two (2) <i>Suspension Points</i> .	The imposition of between two (2) and eight (8) <i>Suspension Points</i> .	The imposition of between eight (8) <i>Suspension Points</i> and a suspension for one (1) year.

APPENDIX 3 – MATCH FEES

Unless otherwise agreed in advance of an *International Match* or *ICC Event*, for the purposes of any sanctions that are to be applied pursuant to this *Code of Conduct*, the following designated *Match Fees* shall apply:

TYPE OF INTERNATIONAL MATCH	DESIGNATED MATCH FEE
Any men's <i>Test Match</i> , <i>One Day International Match</i> or <i>Twenty20 International Matches</i> .	A country-specific amount which is to be determined by the ICC's Chief Executive's Committee in consultation with the relevant <i>National Cricket Federations</i> .
<i>All other International Matches</i> .	No <i>Match Fee</i> will be applied. Accordingly, no <i>Match Referee</i> or <i>Judicial Commissioner</i> shall have jurisdiction under this <i>Code of Conduct</i> to impose any financial sanctions against any <i>Player</i> or <i>Player Support Personnel</i> for a breach of this <i>Code of Conduct</i> . However the remaining range of permissible sanctions (set out in the tables in Article 7.3 and Article 4 of Appendix 2) shall be available to the <i>Match Referee</i> and/or <i>Judicial Commissioner</i> in full.

For the avoidance of doubt, the designated *Match Fee* to be applied for the purposes of an offence committed by a *Player Support Personnel* shall be the same as that which would be applied to a *Player* from the same *National Cricket Federation* participating in the same *International Match*.

APPENDIX 4 - EXPEDITED PROCEDURE FOR CODE OF CONDUCT OFFENCES OCCURRING DURING AN ICC EVENT

Where a *Code of Conduct* offence is alleged to have occurred during, or in relation to, an *International Match* that is played as part of an *ICC Event* (except the *ICC Intercontinental Cup and Shield* in which no expedited procedure is to be applied), the provisions of the *Code of Conduct* shall apply in full save for the amendments described in this Appendix 4, which are deemed to be made in order to ensure that any matters arising can be dealt with expeditiously:

ARTICLE 3 - REPORTING AN ALLEGED OFFENCE UNDER THE CODE OF CONDUCT

- Article 3.2.1.2 – ‘forty-eight (48) hours (where the *Report* is lodged by an *Umpire*) or ninety-six (96) hours (where the *Report* is lodged by the *Team Manager* or CEO of either of the two relevant *National Cricket Federations*)’ is replaced with ‘eighteen (18) hours’.
- Article 3.2.1.3 – ‘seven (7) days’ is replaced with ‘thirty-six (36) hours’.
- Article 3.2.2.1 – ‘five (5) days’ is replaced with ‘twenty-four (24) hours’.
- Article 3.2.2.2 – ‘seven (7) days’ is replaced with ‘thirty-six (36) hours’.
- Article 3.2.3 – ‘seven (7) days’ is replaced with ‘thirty-six (36) hours’.

ARTICLE 4 - NOTIFICATION PROCEDURE

- Article 4.2.2 – ‘Article 5.1’ is replaced with ‘Article 5.1.1’
- Article 4.2.3 – ‘Article 5.1’ is replaced with ‘Article 5.1.1’
- Article 4.6.2 – ‘Article 5.2’ is replaced with ‘Article 5.1.2’
- Article 4.6.3 – ‘Article 5.2’ is replaced with ‘Article 5.1.2’

ARTICLE 5 - THE DISCIPLINARY PROCEDURE

- Articles 5.1 and 5.2 are replaced in their entirety with the following:

5.1 Where a matter proceeds to a hearing:

- 5.1.1 under Article 4.2.2 or 4.2.3, then the case shall be referred to the *Match Referee* for adjudication in accordance with the procedure described in Article 5.2.
- 5.1.2 under Article 4.6.2 or 4.6.3, then the *ICC* shall appoint one member of the *ICC’s Code of Conduct Commission* (who shall be independent of the parties, have had no prior involvement with the case and shall not, unless otherwise agreed between the parties, be from a country participating in the *International Match*, during, or in relation to which, the alleged offence was committed) to sit alone as the *Judicial Commissioner* and the case shall be referred to him/her for adjudication in accordance with the procedure described in Article 5.2.

5.2 Disciplinary Procedure during an *ICC Event*

- 5.2.1 Subject to the discretion of the *Match Referee* or *Judicial Commissioner* to order otherwise for good cause shown by the *Player* or *Player Support Personnel*, the hearing will take place at the time specified in the *Notice of Charge* (which should, in the absence of exceptional circumstances, be no more than twenty-four (24) hours after the receipt by the *Player* or *Player Support Personnel* of the *Notice of Charge*) and in the country in which the alleged offence was committed. For the avoidance of doubt, nothing in this Article 5.2.1 prevents a hearing from being convened at a time during which the *International Match* in relation to which the alleged offence took place, remains in progress.

- 5.2.2 The procedure followed at the hearing shall be at the discretion of the *Match Referee* or *Judicial Commissioner*, provided that the hearing is conducted in a manner which offers the *Player* or *Player Support Personnel* with a fair and reasonable opportunity to present evidence (including the right to call and to question witnesses by telephone or video-conference where necessary), address the *Match Referee* or *Judicial Commissioner* and present his/her case.
- 5.2.3 The hearing before the *Match Referee* or *Judicial Commissioner* shall be in English, and certified English translations shall be submitted of any non-English documents put before the *Match Referee* or *Judicial Commissioner*. The cost of the translation shall be borne by the party offering the document(s). In the case of a *Level 3 Offence* or *Level 4 Offence* only: (a) if required by the *Judicial Commissioner* (at his/her discretion), the ICC shall make arrangements to have the hearing recorded or transcribed; and (b) if requested by the *Player* or *Player Support Personnel*, the ICC shall also arrange for an interpreter to attend the hearing. Such costs of transcription and interpretation shall be paid by the ICC.
- 5.2.4 Where video evidence of the alleged offence is available at the hearing before the *Match Referee* or *Judicial Commissioner*, then it may be relied upon by any party, provided that all other parties shall have the right to make such representations in relation to it that they may see fit.
- 5.2.5 Unless exceptional circumstances apply, each of the following individuals must attend any hearing before the *Match Referee* or *Judicial Commissioner*: (a) the *Player* or *Player Support Personnel* who has been charged with the alleged offence; and (b) the person who lodged the *Report* (or, in the case of the ICC's *Chief Executive Officer*, his/her representative/nominee). Where any such individual has a compelling justification for his/her non-attendance, then they shall be given the opportunity to participate in the hearing before the *Match Referee* or *Judicial Commissioner* by telephone or video conference (if available). Without prejudice to the *Player* or *Player Support Personnel's* ability to call and to question such witnesses as may be necessary and/or to be represented by such other person of his/her own choosing pursuant to Article 5.2.6, one of the *Team Captain*, *Team Vice-Captain* or *Team Manager* of the team that the *Player* or *Player Support Personnel* represents may also attend such hearing before the *Match Referee* or *Judicial Commissioner* to provide additional support and assistance to the *Player* or *Player Support Personnel*.
- 5.2.6 Each of the individuals described in Article 5.2.5(a) and (b) shall have the right (at his/her or its own expense) to be represented at the hearing before the *Match Referee* or *Judicial Commissioner* by such representative (including legal counsel) of his/her or its own choosing. Where the person lodging the *Report* is an *Umpire* or *Match Referee* that officiated in the *International Match* in question or the ICC's *Chief Executive Officer*, then such person shall be entitled to be represented prior to, and during, the hearing (if he/she considers necessary) by a representative of the ICC's Legal Department.
- 5.2.7 The non-attendance of any *Player* or *Player Support Personnel* or his/her representative at the hearing, shall not prevent the *Match Referee* or *Judicial Commissioner* from proceeding with the hearing in his/her absence and issuing a ruling in relation to the offence charged.

- 5.2.8 At the end of a hearing, where the *Match Referee* or *Judicial Commissioner* considers that further evidence is necessary or further time is required to consider the evidence that has been presented, he/she shall adjourn the hearing for an appropriate period of time and make such directions as may be necessary.
- 5.2.9 Alternatively, at the end of a hearing:
- 5.2.9.1 brought under Article 4.2.2:
- a) as soon as possible after the conclusion of the hearing (and, in any event, no later than twenty-four (24) hours thereafter), the *Match Referee* or *Judicial Commissioner* will confirm the *Player* or *Player Support Personnel's* admission that he/she had committed a *Code of Conduct* offence and announce his/her decision in writing, with reasons, setting out: (a) what sanctions, if any, are to be imposed (including any fine and/or period of suspension); (b) the date that any period of suspension shall come into force and effect; and (c) any rights of appeal that may exist pursuant to Article 8.
- 5.2.9.2 brought under Article 4.2.3 (or where the *Player* or *Player Support Personnel* has failed to respond in a timely fashion to the *Notice of Charge*):
- a) the *Match Referee* or *Judicial Commissioner* shall adjourn the hearing (for a period of no less than ten (10) minutes and no more than two (2) hours), following which he/she will reconvene the hearing and verbally announce his/her finding as to whether a *Code of Conduct* offence has been committed;
 - b) where the *Match Referee* or *Judicial Commissioner* determines that a *Code of Conduct* offence has been committed, the *Player* or *Player Support Personnel* may request a short adjournment (of no more than thirty (30) minutes) to prepare any submissions that he/she might wish to make in relation to the appropriate sanction that ought to be applied; and
 - c) as soon as possible after the conclusion of the hearing (and, in any event, no later than twenty-four (24) hours thereafter), the *Match Referee* or *Judicial Commissioner* will announce his/her decision in writing, with reasons, setting out: (a) the finding as to whether a *Code of Conduct* offence had been committed; (b) what sanctions, if any, are to be imposed (including any fine and/or period of suspension); (c) the date that any period of suspension shall come into force and effect; and (d) any rights of appeal that may exist pursuant to Article 8.

- 5.2.10 The *Match Referee* shall have the discretion to announce the substance of his/her decision prior to the issue of the written reasoned decision referred to in Article 5.2.9.
- 5.2.11 A copy of the written reasoned decision will be provided to the *Player* or *Player Support Personnel*, the CEO of the *Player* or *Player Support Personnel's National Cricket Federation*, and the *ICC's Cricket Operations Manager*.
- 5.2.12 Subject only to the rights of appeal under Article 8, the *Match Referee's* or *Judicial Commissioner's* decision shall be the full, final and complete disposition of the matter and will be binding on all parties.

ARTICLE 8 - APPEALS

- Article 8.2.3 - '48 hours' is replaced with '24 hours'.
- Article 8.2.3.1 - '48 hours' is replaced with '24 hours'.
- Article 8.2.3.2 - 'Articles 5.1.2 to 5.1.10' is replaced with 'the amended Articles 5.1 and 5.2'.
- Article 8.2.3.4 - 'seven days' is replaced with '48 hours'.
- Article 8.3.3 - 'seven (7) days' is replaced with '48 hours'.
- Article 8.3.3.2 - 'Articles 5.2.2 to 5.2.13' is replaced with 'the amended Articles 5.1 and 5.2'.
- Article 8.3.3.4 - 'thirty (30) days' is replaced with '72 hours'.

ICC CODE OF CONDUCT FOR UMPIRES

ICC CODE OF CONDUCT FOR UMPIRES

Note: The Umpires Code of Conduct included herewith is currently under review. Until such time as the revised Code has been finalised this Code shall remain applicable.

1 CODE OF CONDUCT

- 1.1 Umpires shall not make any public pronouncement or media comment which is detrimental to:
 - a) the game of cricket in general, or
 - b) any particular tour between Member Countries in which any such Umpire is involved, or
 - c) any tour between Member Countries which is taking place; or
 - d) relations between the Cricket Authority of a Member Country and the Cricket Authority of any other Member Country.
- 1.2 Umpires shall not disclose or comment upon any alleged breach of this Code or the ICC Code of Conduct or any hearing, report or decision arising from such a breach unless such disclosure is required under the provisions of this Code or the ICC Code of Conduct.
- 1.3 Umpires shall not engage, directly or indirectly, in betting or any conduct described in the Appendix.
- 1.4 Umpires shall not use or in any way be concerned in the use or distribution of illegal drugs.
- 1.5 Umpires shall at all times observe and comply with the provisions of any Regulation of ICC which applies to Umpires including but not limited to ICC's Logo Policy from time to time in force.
- 1.6 Umpires shall not engage in any conduct which is prejudicial to the interests of the game of cricket.

2 APPLICATION OF THE CODE

- 2.1 An alleged breach of Clause 1.3 of the Code shall be dealt with by the ICC Code of Conduct Commission, through the ICC Executive Board.
- 2.2 Any other breach of the Code shall be dealt with by the Home Board of the Umpire concerned and the Home Board may, subject to the provisions of the Code, regulate its proceedings in relation thereto as it may think fit.

3 PROCEDURE FOR DEALING WITH DISCIPLINARY MATTERS

3.1 Reports

- 3.1.1 Eligibility to lodge a Report

An alleged breach of this Code by an Umpire may be reported by

 - a) the Referee;
 - b) the Team Manager (in his own right or on behalf of any of his players) of one of the cricket teams playing in the Test Match or ODI in relation to which such breach is alleged to have occurred;

- c) the Chief Executive Officer of a Cricket Authority whose Member Country was represented by one of the cricket teams playing in the Test Match or ODI in relation to which such breach is alleged to have occurred;
 - d) the ICC Chief Executive.
- 3.1.2 If any person eligible to lodge a report becomes aware of any alleged breach of the Code by an Umpire, he shall report the alleged breach in writing to the ICC Chief Executive as soon as possible and, forthwith upon the receipt of such written report, the ICC Chief Executive shall be responsible for informing the Home Board of its contents.

3.2 Hearings by the ICC Code of Conduct Commission

- 3.2.1 If an Umpire is reported for an alleged breach of Clause 1.3, the ICC Chief Executive shall be responsible for informing the Chairman of the ICC Code of Conduct Commission of the report's contents and any investigation shall be conducted in accordance with the Commission's Terms of Reference and not by the Home Board.

3.3 Hearings by the Home Board

- 3.3.1 A hearing of any alleged breach of the Code shall be arranged by the Home Board as soon as possible and practical after the Home Board has been informed by the ICC Chief Executive of the contents of the report of the alleged breach. Notice of the hearing shall be given by the Home Board to the Umpire concerned and the Home Board shall send him a copy of the said report. If the Umpire shall elect to have a legal representative appear on his behalf at the hearing, he shall forthwith notify the Home Board of his decision and the name of his legal representative. If the Umpire fails to do so, such legal representative may only appear on the Umpire's behalf at the sole and absolute discretion of the Chairman who shall require a good reason for such failure on the part of the Umpire.
- 3.3.2 The hearing should be attended by the Umpire against whom the alleged breach has been made, by any legal representative instructed by the Umpire to appear on his behalf and by any eligible person who shall have lodged a report with the ICC Chief Executive in relation to such breach, none of whom may be denied the right to appear at the hearing. The hearing may also be attended by a representative of ICC and by the Chief Executive Officer of the Home Board and by any other duly appointed representative of the Home Board, including a legal representative instructed by the Home Board to appear on its behalf. If the Umpire against whom the alleged breach is made fails to attend at the time and place fixed for the hearing, reasonable notice of which shall have been duly given to him, the hearing may be conducted in his absence. The Home Board shall appoint an individual to preside at the hearing as the Chairman, to decide whether or not a breach has occurred and, if so, to determine what penalty should be imposed.
- 3.3.3 The Chairman shall allow the Umpire concerned to present evidence, either oral or written, in support. The Chairman may, at his discretion, call such witnesses as may be necessary.

- 3.3.4 In hearing evidence of the alleged breach of the Code and in deciding what action should be taken in relation thereto, the Chairman shall have due regard to the principles of natural justice, guidelines on which appear as an appendix to the ICC Code of Conduct, and to the need to ensure a fair and prompt determination of the alleged breach.
- 3.3.5 The Home Board shall always have the right to investigate any incident which, in its opinion, may give rise to a breach of the Code, irrespective of whether or not a report in relation thereto has been lodged with the ICC Chief Executive; and, if it decides to hold a hearing in relation thereto, it shall, as soon as possible, notify in writing the Umpire in respect of whom an alleged breach of the Code has been made of the Home Board's decision and of the circumstances giving rise to the alleged breach and shall send a copy of the said notice to the ICC Chief Executive.

3.4 Decision

- 3.4.1 The Chairman's decision is final.
- 3.4.2 As soon as possible after the Chairman has arrived at his decision, he shall inform the chief executive officer of the Home Board and the Umpire concerned of his decision.
- 3.4.3 The chief executive officer of the Home Board shall announce the decision of the Chairman to the news media.
- 3.4.4 The Chairman and the Home Board shall not discuss or comment upon the Chairman's decision at any time save with the express authority in writing of the ICC Chief Executive.

3.5 Penalties

- 3.5.1 In the event that, after a hearing under the Code, the Chairman decides on a balance of probability that an Umpire is in breach of the Code, the Chairman may, in his absolute discretion impose any penalty by way of reprimand and/or fine and/or suspension, including power to suspend a fine or a suspension for a period not exceeding one year.
- 3.5.2 In deciding what penalty to impose on an Umpire for a breach of the Code, the Chairman shall have regard to:
 - a) The character of that Umpire
 - b) The nature of the action on the part of that Umpire giving rise to the breach of the Code; and
 - c) Any other circumstances of the case which may seem to the Chairman relevant to the imposition of a penalty.
- 3.5.3 The Home Board shall co-operate with the Chairman in ensuring that a penalty imposed on any such Umpire by way of suspension is carried into full force and effect and the Home Board is hereby authorised under the Code to take all necessary steps to enforce such suspension.
- 3.5.4 In the event that the Chairman shall decide to impose a fine on an Umpire, the fine shall be paid by the Umpire on whom it is imposed within one calendar month of the date on which he is notified of the Chairman's decision. In this respect, the ICC Chief Executive shall arrange with the Home Board for the fine to be paid by the Umpire concerned to the Home Board who will, in turn, forward it to ICC.

Any Umpire failing to pay such fine to the Home Board within the said period shall not, until such time as the fine has been paid, be eligible for appointment as an Umpire by ICC or by the Home Board for any international or national team fixture under the control of the Home Board.

- 3.5.5 In the event that the Chairman exercises his power to suspend any fine or suspension on an Umpire who is subsequently found to be in further breach of the Code during the period of suspension, the original penalty will automatically be imposed. The Chairman of the hearing of the subsequent breach may impose a penalty in respect of such further breach.

4 RECORDS

The Home Board shall supply ICC with a copy of all hearings conducted by it under the Code and ICC shall be responsible for keeping copies of all reports and of all hearings.

5 GENERAL

- 5.1 If there shall be any conflict between the provisions of the Code and the provisions of any code of conduct or similar regulation issued by any Cricket Authority, the provisions of the Code shall prevail and shall override any such code of conduct.
- 5.2 It shall be an implied condition in any contract, agreement, understanding or arrangement involving a Cricket Authority or a Home Board and an Umpire that the provisions of the Code shall be binding on such an Umpire and that his acceptance of an appointment to stand as an Umpire in any Test Match or ODI or to be a member of the international panel of Umpires established by ICC shall constitute his acceptance of his obligation to be bound by and his undertaking, directly with ICC as well as with the Home Board, to observe at all times the provisions of the Code.
- 5.3 Each Cricket Authority shall bring to the express notice of its Umpires the provisions of the Code and shall procure the compliance by its Umpires with the provisions of the Code.

APPENDIX 1

An Umpire shall be in breach of Clause 1.3 of the Code if he is found to have engaged in any of the following conduct and the penalties to be considered are the same as those set out in Clause C4 of the Code of Conduct for Players and

Team Officials:

- 1 Bet on any Test Match, One Day International Match or representative cricket match ('Match') or series of Matches, or on any event connected with any Match or series of Matches ('Event'), in which such Umpire took part or in which the Member Country of any such Umpire was represented;
- 2 Induced or encouraged any other person to bet on any Match or series of Matches or on any Event or to offer the facility for such bets to be placed;
- 3 Gambled or entered into any other form of financial speculation on any Match or on any Event or induced or encouraged any other person to do so;
- 4 Was a party to contriving or attempting to contrive the result of any Match or the occurrence of any Event;
- 5 Failed to meet the standards of a first-class Umpire owing to an arrangement relating to betting on the outcome of any Match or on the occurrence of any Event;
- 6 Induced or encouraged any player not to perform on his merits in any Match owing to any such arrangement;
- 7 Received from another person any money, benefit or other reward (whether financial or otherwise) for the provision of any information concerning the weather, the teams, the state of the ground, the status of, or the outcome of, any Match or the occurrence of any Event unless such information has been provided to a newspaper or other form of media in accordance with an obligation entered into in the normal course and disclosed in advance to the Home Board;
- 8 Received or provided any money, benefit or other reward (whether financial or otherwise) which could bring him or the game of cricket into disrepute;
- 9 Received any approaches from another person to engage in conduct such as that described in any of the above Paragraphs 1 to 8 and has failed to disclose the same to the ICC Chief Executive or to the chief executive officer of the Home Board;
- 10 Is aware that any other Umpire or individual has engaged in conduct, or received approaches, such as described in any of the above Paragraphs 1 to 9 and has failed to disclose the same to the ICC Chief Executive or to the chief executive officer of the Home Board;
- 11 Has received or is aware that any other person has received threats of any nature which might induce him to engage in conduct, or acquiesce in any proposal made by an approach, such as that described in any of the above Paragraphs 1 to 10 and has failed to disclose the same to the ICC Chief Executive or to the Chief Executive Officer of the Home Board;
- 12 Has engaged in any conduct which, in the opinion of the Executive Board, relates directly or indirectly to any of the above paragraphs 1 to 11 and is prejudicial to the interests of the game of cricket.

ICC ANTI-RACISM CODE FOR PLAYERS AND PLAYER SUPPORT PERSONNEL

ICC ANTI-RACISM CODE FOR PLAYERS AND PLAYER SUPPORT PERSONNEL

		PAGE
Article 1	Scope and Application	15.2
Article 2	Offence	15.3
Article 3	Reporting an Alleged Offence Under the <i>Anti-Racism Code</i>	15.3
Article 4	Notification and Conciliation Procedure	15.4
Article 5	The Disciplinary Procedure	15.7
Article 6	Standard of Proof and Evidence	15.11
Article 7	Sanctions	15.12
Article 8	Appeals	15.15
Article 9	Recognition of Decisions	15.16
Article 10	Amendment and Interpretation of the <i>Anti-Racism Code</i>	15.16
Appendix 1	Definitions	15.18
Appendix 2	Expedited Procedure for Offences Under the <i>Anti-Racism Code</i> Occurring During an ICC Event	15.20

INTRODUCTION

The ICC is the international federation responsible for the global governance of the sport of cricket and the Anti-Racism Code for Players and Player Support Personnel (the 'Anti-Racism Code') is adopted and implemented as part of the ICC's continuing efforts to maintain the public image, popularity and integrity of cricket by providing: (a) an effective means to deter any participant from conducting themselves in a manner that may be construed as racially and/or religiously offensive; and (b) a robust disciplinary procedure pursuant to which all matters of improper conduct of this nature can be dealt with fairly, with certainty and in an expeditious manner.

Unless otherwise indicated, references to Articles and Appendices are to articles and appendices of the *Anti-Racism Code*. Words in italicised text in the *Anti-Racism Code* are defined terms and their definitions are set out in Appendix 1.

ARTICLE 1 - SCOPE AND APPLICATION

- 1.1 All *Players* and *Player Support Personnel* are automatically bound by and required to comply with all of the provisions of the *Anti-Racism Code*. Accordingly, by their participation (in the case of a *Player*) or assistance in participation (in the case of a *Player Support Personnel*) in an *International Match*, such *Players* or *Player Support Personnel* shall be deemed to have agreed:
 - 1.1.1 that it is their personal responsibility to familiarise themselves with all of the requirements of the *Anti-Racism Code*, including what conduct constitutes an offence under the *Anti-Racism Code*;
 - 1.1.2 to submit to the exclusive jurisdiction of any *Judicial Commissioner* or *Appeal Panel* convened under the *Anti-Racism Code* to hear and determine charges brought (and any appeals in relation thereto) pursuant to the *Anti-Racism Code*; and
 - 1.1.3 not to bring any proceedings in any court or other forum that are inconsistent with the foregoing submission to the jurisdiction of the *Judicial Commissioner* or *Appeal Panel*.
- 1.2 All *Players* and *Player Support Personnel* shall continue to be bound by and required to comply with the *Anti-Racism Code* until he/she has not participated (in the case of a *Player*), or assisted a *Player's* participation (in the case of a *Player Support Personnel*) in an *International Match* for a period of three (3) months and the ICC shall continue to have jurisdiction over him/her under the *Anti-Racism Code* thereafter in respect of matters taking place prior to that point.
- 1.3 Without prejudice to Articles 1.1 and 1.2, the ICC and the *National Cricket Federations* shall be responsible for promoting *Anti-Racism Code* awareness and education amongst all *Players* and *Player Support Personnel*.
- 1.4 It is acknowledged that certain *Players* and *Player Support Personnel* may also be subject to other rules of *National Cricket Federations* that govern discipline and/or conduct, and that the same conduct of such *Players* and/or *Player Support Personnel* may implicate not only the *Anti-Racism Code* but also such other rules that may apply. For the avoidance of any doubt, *Players* and *Player Support Personnel* acknowledge and agree that:
 - (a) the *Anti-Racism Code* is not intended to limit the responsibilities of any *Player* or *Player Support Personnel* under such other rules; and
 - (b) nothing in such other rules shall be capable of removing, superseding or amending in any way the jurisdiction of the *Judicial Commissioner* or *Appeal Panel* to determine matters properly arising pursuant to the *Anti-Racism Code*.

- 1.5 The conduct prohibited under the *Anti-Racism Code* may also constitute a breach of other applicable laws or regulations (e.g. governing equal opportunities and/or anti-discrimination). The *Anti-Racism Code* is intended to supplement such laws and regulations with further rules of professional conduct for those involved in the sport of cricket. It is not intended, and may not be interpreted, construed or applied, to prejudice or undermine in any way the application of such laws and regulations. *Players and Player Support Personnel* must comply with all applicable laws and regulations at all times.
- 1.6 For the avoidance of any doubt:
- 1.6.1 the *Anti-Racism Code* is not intended in any way to replace the ICC Anti-Racism Policy for Members (as amended from time to time) which shall remain in full force and effect and to which the ICC and all *National Cricket Federations* agree to be bound at all times;
 - 1.6.2 all *Umpires* and *Match Referees* officiating in any *International Matches* are automatically bound by and required to comply with all of the provisions of the *ICC Code of Conduct for Umpires and Referees*; and
 - 1.6.3 where a representative side of a *National Cricket Federation* participates in an *International Tour Match* against a domestic or invitational team, for the purposes of their participation in such *International Tour Match*:
 - 1.6.3.1 all *Players* and *Player Support Personnel* representing the *National Cricket Federation's* representative side are automatically bound by, required to comply with, and shall submit themselves to the jurisdiction of this *Anti-Racism Code*; and
 - 1.6.3.2 all players or player support personnel representing the domestic or invitational team shall not be bound by this *Anti-Racism Code*. Instead, such individuals will be bound by, required to comply with, and shall submit themselves to the jurisdiction of the relevant *National Cricket Federation's* own applicable rules of conduct.

ARTICLE 2 - OFFENCE

- 2.1 The following conduct, if committed by a *Player* or *Player Support Personnel* at any time during, or in relation to, an *International Match*, shall amount to an offence under the *Anti-Racism Code*:
- 2.1.1 Engaging in any conduct (whether through the use of language, gestures or otherwise) which is likely to offend, insult, humiliate, intimidate, threaten, disparage or vilify any reasonable person in the position of a *Player*, *Player Support Personnel*, *Umpire*, *Match Referee* or any other person (including a spectator) on the basis of their race, religion, culture, colour, descent, national or ethnic origin.

ARTICLE 3 - REPORTING AN ALLEGED OFFENCE UNDER THE ANTI-RACISM CODE

Note: Where an offence under the *Anti-Racism Code* is alleged to have occurred during, or in relation to, an *International Match* that is played as part of an ICC Event, the *Anti-Racism Code* shall apply in full, but with a series of amendments to the reporting, notification, disciplinary and appeals procedure (Articles 3, 4, 5 and 8) in order to ensure that any matters arising can be dealt with expediently. Such amendments are described in detail in Appendix 2.

- 3.1 Any one of the following individuals can report an alleged offence under the *Anti-Racism Code* by lodging a report in the manner described in Article 3.2, below (a '**Report**')
- 3.1.1 an *Umpire* that officiated in the *International Match* during, or in relation to which, the alleged offence was committed;
 - 3.1.2 the *Match Referee* that was appointed to officiate in the *International Match* during, or in relation to which, the alleged offence was committed;
 - 3.1.3 the *Team Manager* or CEO of either of the two *National Cricket Federations* whose representative teams participated in the *International Match* during, or in relation to which, the alleged offence was committed; or
 - 3.1.4 the *ICC's Chief Executive Officer*.
- 3.2 All Reports must be completed on Form 'Rep 1' (or such other form as may be made available for such purposes by the *ICC* from time to time). All *Reports* must be signed and dated by the person lodging the *Report* and must be lodged with the *ICC's Head of Legal* as soon as reasonably practicable, and in any event no later than seven (7) days after: (a) the commission of the alleged offence; or (b) the alleged offence was brought to the attention of the person lodging the *Report*.
- 3.3 Where it is alleged that a *Player* or *Player Support Personnel* has committed more than one offence under the *Anti-Racism Code* during, or in relation to, an *International Match* (whether arising out of the same set of facts or otherwise), then a separate *Report* should be filed in accordance with this Article 3 for each of the offences alleged to have been committed.

ARTICLE 4 - NOTIFICATION AND CONCILIATION PROCEDURE

- 4.1 Where the *ICC's Head of Legal* receives a *Report* lodged under Article 3, he/she must promptly carry out an investigation into the circumstances detailed in the *Report* (which may include speaking with relevant parties and reviewing relevant documents and other supporting materials) in order to determine within five (5) business days of receipt of the *Report* whether the *Player* or *Player Support Personnel* named in the *Report* has a case to answer.
- 4.2 If the initial review of the *Report* reveals that there is no case to answer, then the *ICC* shall notify the person who filed the *Report* of that fact, and the matter shall not proceed any further.
- 4.3 If the initial review of the *Report* reveals that there is a case to answer, then, provided that the *ICC* consents to the matter being resolved by a process of conciliation (such consent not to be withheld unless it determines, acting reasonably, that the circumstances of the matter do no merit resolution by conciliation or there is a genuine and reasonable concern that a just and appropriate resolution of the matter will not be reached through a process of conciliation), the *ICC* shall comply with the following procedure:
- 4.3.1 The *ICC's Head of Legal* shall notify the following individuals of their entitlement to have the matter referred at the first instance to a process of conciliation and seek express written consent from each of them to proceed on that basis:

- 4.3.1.1 the *Player* or *Player Support Personnel* named in the *Report*; and
- 4.3.1.2 the individual(s) who has/have been the subject of the alleged offence.
- 4.3.2 Where the *ICC* does not consent to the matter being resolved by a process of resolution or where the *ICC's Head of Legal* is unable to obtain the express written consent from both of the individuals described in Articles 4.3.1.1 and 4.3.1.2 within a period of forty-eight (48) hours after receipt by those individuals of such notice, then the matter shall not be referred to a process of conciliation, instead it shall proceed in accordance with Article 4.4.
- 4.3.3 Where a matter proceeds to conciliation under Article 4.3.1, then the case shall be referred to a *Conciliator* who shall be responsible for overseeing a process of conciliation to take place as soon as possible and, in any event, no later than seven (7) days after the receipt by the *ICC's Head of Legal* of the consents described in Article 4.3.1, in accordance with the following procedure:
 - 4.3.3.1 The *ICC* shall appoint one independent *Conciliator* who will oversee the conciliation sitting alone. For the avoidance of doubt, the appointed *Conciliator* may be from a country participating in the *International Match* during, or in relation to which, the alleged offence was committed, provided that the *Conciliator* remains independent of the relevant parties and the *ICC* at all times.
 - 4.3.3.2 Unless exceptional circumstances apply, each of the parties identified in Articles 4.3.1.1 and 4.3.1.2, together with: (a) the person who lodged the *Report* (or, in the case of the *ICC's Chief Executive Officer*, his/her nominee); and (b) a representative of the *ICC's* Legal Department, must attend any conciliation meeting that is scheduled by the *Conciliator*. Each individual shall have the right (at his/her or its own expense) to be represented at such conciliation meeting by such representative (including legal counsel) of his/her or its own choosing. Where any such individual has a compelling justification for his/her non-attendance, then they shall be given the opportunity to participate in the conciliation by telephone or video conference (if available). In addition, any one of the *Team Captain*, *Team Vice Captain* or *Team Manager* of the team that any *Player* or *Player Support Personnel* attending such conciliation meeting represents, may also attend such conciliation meeting to provide additional support and assistance to that *Player* or *Player Support Personnel*.
 - 4.3.3.3 Subject to the discretion of the *Conciliator* to order otherwise for good cause shown by either party, conciliation meetings shall take place in the country in which the alleged offence was committed.
 - 4.3.3.4 All of the parties involved in the conciliation procedure must fully engage with the *Conciliator* and the conciliation procedure with an open mind and must act, at all times, honestly and in good faith.
 - 4.3.3.5 The procedure which is to be followed prior to, and during the conciliation meeting shall be entirely at the discretion of the *Conciliator*, provided that any such meeting is

conducted in an open, inquisitive, non-adversarial and fair manner which enables all of the attending parties a reasonable opportunity to present any evidence that is deemed by the *Conciliator* to be appropriate and to address the *Conciliator* on any matter relevant to the alleged offence. In accordance with Article 6.2, all statements, submissions and evidence made, heard or disclosed during any part of the conciliation process shall be so made, heard or disclosed strictly (unless the relevant party agrees otherwise) on a 'without prejudice' basis and may only be used by any party for the purposes of the conciliation process only.

- 4.3.3.6 During the conciliation meeting, the *Conciliator* will discuss the circumstances of the alleged offence with the relevant parties and explore the possibility of reaching a consensual solution for how to resolve the matter without invoking the disciplinary procedure set out in Article 5. Such a solution may incorporate, without limitation, any of the following (or any combination of the following) outcomes: (a) the voluntary imposition of a period of suspension (which period must be determined having due regard to the range of permissible sanctions in Article 7.3) by the *Player* or *Player Support Personnel* alleged to have committed the offence; and/or (b) a public apology and/or explanation as to the parties' conduct and circumstances surrounding the alleged offence; and/or (c) a private apology and/or explanation as to the parties' conduct and circumstances surrounding the alleged offence; and/or (d) a joint press statement being issued about the parties' conduct and circumstances surrounding the alleged offence and/or its resolution by conciliation; and/or (e) an agreement by the *Player* or *Player Support Personnel* alleged to have committed the offence, to undergo a specified programme of education and/or counselling designed to promote the understanding and awareness of issues directly relevant to the offence that is alleged to have been committed.
- 4.3.3.7 At the end of the conciliation meeting, if the *Conciliator* is satisfied that all of the parties have reached a consensual resolution of the matter, then he/she shall document such resolution and arrange for the signature of all relevant parties to be attested to such document. Any consensual resolution reached by all parties during such conciliation meeting shall be the full, final and complete disposition of the matter and will be binding on all parties.
- 4.3.3.8 At the end of the conciliation meeting, if the *Conciliator* is not satisfied that all of the parties have reached a consensual resolution of the matter, then the conciliation process shall be terminated immediately and the matter shall proceed in accordance with Article 4.4.
- 4.3.3.9 All parties involved in the conciliation procedure shall treat such procedure as strictly confidential, save that nothing in this Article shall prevent either of the parties (or any relevant *National Cricket Federation*) publicly confirming the date of any conciliation meeting, the offence that is alleged to have been committed and/or the name of the *Player* or *Player Support Personnel* charged.

- 4.4 If the initial review of the *Report* reveals that there is a case to answer and either: (a) the ICC did not consider it to be an appropriate matter for resolution through conciliation (Article 4.3); or (b) the relevant parties did not consent to the matter being resolved through a conciliation process (Article 4.3.2); or (b) following a conciliation meeting the *Conciliator* was not satisfied that the parties were able to reach a consensual resolution (Article 4.3.3.8), then the ICC shall promptly provide a copy of the *Report*, together with a completed Form 'Not 1' (such documents comprising the '**Notice of Charge**') to the following individuals:
- 4.4.1 the *Player* or *Player Support Personnel* named in the *Report*;
 - 4.4.2 the *Team Manager* of the relevant *Player* or *Player Support Personnel* named in the *Report*; and
 - 4.4.3 the CEO of the *National Cricket Federation* to which the relevant *Player* or *Player Support Personnel* is affiliated.
- 4.5 The *Notice of Charge* shall specify that the *Player* or *Player Support Personnel* shall have the following options:
- 4.5.1 he/she may admit the offence charged and accede to the proposed sanction specified in the *Notice of Charge* (which sanction shall be strictly at the ICC's discretion, but at all times within the appropriate range for the offence). In such circumstances, and provided that such admission has been received by the ICC's *Head of Legal* prior to the commencement of the hearing at the time/place specified in the *Notice of Charge*, the hearing before the *Judicial Commissioner* shall not be required and no further action shall be taken, save that the ICC shall promptly issue a public statement confirming: (a) the commission of an offence under the *Anti-Racism Code*; and (b) the imposition of the applicable sanction specified in the *Notice of Charge*; or
 - 4.5.2 he/she may admit the offence charge but dispute the proposed sanction specified in the *Notice of Charge*, in which case the matter shall proceed to a hearing in accordance with Article 5.1; or
 - 4.5.3 he/she may deny the offence charged, in which case the matter shall proceed to a hearing in accordance with Article 5.1.

ARTICLE 5 - THE DISCIPLINARY PROCEDURE

- 5.1 Where a matter proceeds to a hearing under Article 4.5.2 or 4.5.3, then the case shall be referred to a *Judicial Commissioner* for adjudication in accordance with the following procedure:
- 5.1.1 As soon as reasonably possible, the ICC shall appoint one member from the ICC's *Code of Conduct Commission* to sit as the *Judicial Commissioner* to hear the case sitting alone. The appointed member shall be independent of the parties, have had no prior involvement with the case and shall not, unless otherwise agreed between the parties, be from a country participating in the *International Match* during, or in relation to which, the alleged offence was committed.
 - 5.1.2 The *Judicial Commissioner* shall convene a preliminary hearing with the ICC and its legal representatives, and with the *Player* or *Player Support Personnel* and his/her legal representatives (if any). The preliminary hearing should take place as soon as possible (provided that the *Player* or *Player Support Personnel* shall be given a reasonable period of notice of the same) by telephone conference call unless the *Judicial Commissioner* determines otherwise. The non-participation of the *Player* or *Player Support*

Personnel or his/her representative at the preliminary hearing shall not prevent the *Judicial Commissioner* from proceeding with the preliminary hearing, whether or not any written submissions are made on behalf of the *Player* or *Player Support Personnel*.

- 5.1.3 The purpose of the preliminary hearing shall be to allow the *Judicial Commissioner* to address any preliminary issues. In particular (but without limitation), the *Judicial Commissioner* shall:
- 5.1.3.1 determine the date(s) upon which the full hearing shall be held. Save in exceptional circumstances or where the parties otherwise agree, the full hearing should take place no longer than fourteen (14) days after the receipt by the *Player* or *Player Support Personnel* of the *Notice of Charge*;
 - 5.1.3.2 establish dates reasonably in advance of the date of the full hearing by which:
 - a) the *ICC* shall submit an opening brief with argument on all issues that the *ICC* wishes to raise at the hearing and a list of the witnesses that the *ICC* intends to call at the hearing (and a summary of the subject areas of the witness's anticipated testimony), and enclosing copies of the exhibits that the *ICC* intends to introduce at the hearing;
 - b) the *Player* or *Player Support Personnel* shall submit an answering brief, addressing the *ICC*'s arguments and setting out argument on the issues that he/she wishes to raise at the hearing, as well as a list of the witnesses that he/she intends to call at the hearing (and a summary of the subject areas of the witness's anticipated testimony), and enclosing copies of the exhibits that he/she intends to introduce at the hearing; and
 - c) the *ICC* may (at its discretion) submit a reply brief, responding to the answer brief of the *Player* or *Player Support Personnel* and listing any rebuttal witnesses that the *ICC* intends to call at the hearing (and a summary of the subject areas of the witness's anticipated testimony), and enclosing copies of any other exhibits that the *ICC* intends to introduce at the hearing; and
 - 5.1.3.3 make such order as the *Judicial Commissioner* shall deem appropriate in relation to the production of relevant documents and/or other materials between the parties.
- 5.1.4 Subject to the discretion of the *Judicial Commissioner* to order otherwise for good cause shown by either party, hearings before the *Judicial Commissioner* shall take place in the country in which the alleged offence was committed.
- 5.1.5 The procedure followed at the hearing shall be at the discretion of the *Judicial Commissioner*, provided that the hearing is conducted in a manner which offers the *Player* or *Player Support Personnel* a fair and reasonable opportunity to present evidence (including the right to call and to question witnesses by telephone or video-conference where necessary), address the *Judicial Commissioner* and present his/her case. For the avoidance of any doubt, in accordance with Article 6.2, unless the relevant party agrees otherwise, no evidence shall be adduced, given or accepted during any hearing before the *Judicial Commissioner* in relation to anything that may have been said or disclosed during any part of any 'without prejudice' conciliation process carried out pursuant to Article 4.3.

- 5.1.6 The hearing before the *Judicial Commissioner* shall be in English, and certified English translations shall be submitted of any non-English documents put before the *Judicial Commissioner*. The cost of the translation shall be borne by the party offering the document(s). If required by the *Judicial Commissioner* (at his/her discretion), the ICC shall make arrangements to have the hearing recorded or transcribed. If requested by the *Player* or *Player Support Personnel*, the ICC shall also arrange for an interpreter to attend the hearing. Such costs of transcription and interpretation shall be paid by the ICC.
- 5.1.7 Where video evidence of the alleged offence is available at the hearing before the *Judicial Commissioner*, then it may be relied upon by any party, provided that all other parties shall have the right to make such representations in relation to it that they may see fit.
- 5.1.8 Unless exceptional circumstances apply, each of the following individuals must attend any hearing before the *Judicial Commissioner*: (a) the *Player* or *Player Support Personnel* who has been charged with the alleged offence; (b) the person who lodged the *Report* (or, in the case of the ICC's *Chief Executive Officer*, his/her representative/nominee); and (c) a representative of the ICC's Legal Department. Where any such individual has a compelling justification for his/her non-attendance, then they shall be given the opportunity to participate in the hearing before the *Judicial Commissioner* by telephone or video conference (if available). Without prejudice to the *Player* or *Player Support Personnel's* ability to call and to question such witnesses as may be necessary and/or to be represented by such other person of his/her own choosing pursuant to Article 5.1.9, one of the *Team Captain*, *Team Vice-Captain* or *Team Manager* of the team that the *Player* or *Player Support Personnel* represents may also attend such a hearing to provide additional support and assistance to the *Player* or *Player Support Personnel*.
- 5.1.9 Each of the individuals described in Article 5.1.8(a) and (b) shall have the right (at his/her or its own expense) to be represented at the hearing before the *Judicial Commissioner* by such representative (including legal counsel) of his/her or its own choosing. Where the person lodging the *Report* is an *Umpire* or *Match Referee* that officiated in the *International Match* in question or the ICC's *Chief Executive Officer*, then such person shall be entitled to be represented prior to, and during, the hearing (if he/she considers necessary) by a representative of the ICC's Legal Department.
- 5.1.10 The non-attendance of the *Player* or *Player Support Personnel* or his/her representative at the hearing, after proper notice of the hearing has been provided, shall not prevent the *Judicial Commissioner* from proceeding with the hearing in his/her absence, whether or not any written submissions are made on his/her behalf.
- 5.1.11 At the end of a hearing, where the *Judicial Commissioner* considers that further evidence is necessary or further time is required to consider the evidence that has been presented, he/she shall adjourn the hearing for an appropriate period of time and make such directions as may be necessary.

5.1.12 Alternatively, at the end of a hearing:

5.2.12.1 brought under Article 4.5.2:

- a) as soon as possible after the conclusion of the hearing (and, in any event, no later than forty-eight (48) hours thereafter), the *Judicial Commissioner* will confirm the *Player* or *Player Support Personnel's* admission that he/she had committed an offence under the *Anti-Racism Code* and announce his/her decision in writing, with reasons, setting out: (a) what sanctions, if any, are to be imposed; (b) the date that any period of suspension shall come into force and effect; and (c) any rights of appeal that may exist pursuant to Article 8.

5.2.12.2 brought under Article 4.5.3 (or where the *Player* or *Player Support Personnel* has failed to respond in a timely fashion to the *Notice of Charge*):

- a) the *Judicial Commissioner* shall adjourn the hearing (for a period of no less than ten (10) minutes and no more than twenty-four (24) hours), following which he/she will reconvene the hearing and verbally announce his/her finding as to whether an offence under the *Anti-Racism Code* has been committed;
- b) where the *Judicial Commissioner* determines that an offence under the *Anti-Racism Code* has been committed, the *Player* or *Player Support Personnel* may request a short adjournment (of no more than thirty (30) minutes) to prepare any submissions that he/she might wish to make in relation to the appropriate sanction that ought to be applied; and
- c) as soon as possible after the conclusion of the hearing (and, in any event, no later than forty-eight (48) hours thereafter), the *Judicial Commissioner* will announce his/her decision in writing, with reasons, setting out: (a) the finding as to whether an offence under the *Anti-Racism Code* had been committed; (b) what sanctions, if any, are to be imposed; (c) the date that any period of suspension shall come into force and effect; and (d) any rights of appeal that may exist pursuant to Article 8.

5.1.13 The *Judicial Commissioner* shall have the discretion to announce the substance of his/her decision prior to the issue of the written reasoned decision referred to in Article 5.1.12.

5.1.14 A copy of the written reasoned decision will be provided to the *Player* or *Player Support Personnel*, the CEO of the *Player* or *Player Support Personnel's National Cricket Federation* and the ICC's *Cricket Operations Manager*.

5.1.15 Subject only to the rights of appeal under Article 8, the *Judicial Commissioner's* decision shall be the full, final and complete disposition of the matter and will be binding on all parties.

General Principles of Procedure

- 5.2 Where a *Report* is filed by more than one of the individuals described in Article 3.1 in relation to the same alleged offence under the *Anti-Racism Code*, then the *Player* or *Player Support Personnel* alleged to have committed the offence will only be served with one *Notice of Charge* in accordance with the procedures set out in Article 4. However, all persons who filed a *Report* (or, in the case of the ICC's *Chief Executive*, his/her representative/nominee) in relation to the alleged offence are required to attend the hearing before the *Judicial Commissioner* unless there is a compelling justification for his/her non-attendance, in which case they shall be given the opportunity to participate in the hearing by telephone or video conference (if available).
- 5.3 Where two or more *Players* or *Player Support Personnel* are alleged to have committed offences under the *Anti-Racism Code*, they may both be dealt with at the same hearing where the proceedings arise out of the same incident or set of facts, or where there is a clear link between separate incidents.
- 5.4 Where a *Player* or *Player Support Personnel* is alleged to have committed more than one breach of the *Anti-Racism Code* during, or in relation to, the same *International Match*, then all of the alleged offences may be dealt with at the same hearing.
- 5.5 Any failure or refusal by any *Player* or *Player Support Personnel* to provide assistance to a *Judicial Commissioner* in connection with any charge made pursuant to this *Anti-Racism Code* may constitute a separate offence (depending upon the seriousness and context of such failure or refusal) under Articles 2.1.8, 2.2.11, 2.3.3 or 2.4.3 of the *Code of Conduct*.
- 5.6 Where a *Judicial Commissioner* is, or becomes unwilling or unable to hear a case (for example, where he/she finds him/herself in a position of conflict), then the ICC's *Head of Legal* shall have the discretion to appoint another member of the ICC's *Code of Conduct Commission* as a replacement to the *Judicial Commissioner* and all of the remaining procedure will apply accordingly.
- 5.7 The ICC will issue a public announcement regarding any decision of the *Judicial Commissioner* made under the *Anti-Racism Code*, as soon as is reasonably practicable after the decision has been communicated to the parties. The public announcement of the decision may include details of the offences committed under the *Anti-Racism Code* and of the sanctions imposed, if any. Until such time as a public announcement is published, all parties and participants in the proceedings shall treat such proceedings as strictly confidential. For the avoidance of doubt, nothing in this Article shall prevent any party (or any relevant *National Cricket Federation*) publicly confirming the date of the hearing, the offence that is alleged to have been committed and/or the name of the *Player* or *Player Support Personnel* charged.

ARTICLE 6 - STANDARD OF PROOF AND EVIDENCE

- 6.1 Unless otherwise described herein, the standard of proof in all cases brought under the *Anti-Racism Code* shall be whether the *Judicial Commissioner* is comfortably satisfied, bearing in mind the seriousness of the allegation that is made, that the alleged offence has been committed. This standard of proof in all cases shall be determined on a sliding scale from, at a minimum, a mere balance of probability (for the least serious offences) up to proof beyond a reasonable doubt (for the most serious offences).

- 6.2 The *Judicial Commissioner* shall not be bound by judicial rules governing the admissibility of evidence. Instead, facts relating to any alleged offence under the *Anti-Racism Code* may be established by any reliable means, including admissions. However, all statements, submissions and/or evidence made, heard or disclosed during any part of any conciliation process pursuant to Article 4.3, shall be so made, heard or disclosed strictly (unless the relevant party agrees) on a 'without prejudice' basis and used for the purposes of the conciliation process only. Accordingly, no such statements, submissions and/or evidence shall be adduced, given or accepted during any disciplinary hearing before the *Judicial Commissioner* without the express consent of the relevant party.
- 6.3 The *Judicial Commissioner* may draw an inference adverse to the *Player* or *Player Support Personnel* who is asserted to have committed an offence under the *Anti-Racism Code* based on his/her refusal, without compelling justification, after a request made in a reasonable time in advance of the hearing, to appear at the hearing (either in person or telephonically as directed by the *Judicial Commissioner*) and/or to answer any relevant questions.

ARTICLE 7 - SANCTIONS

- 7.1 Where a *Judicial Commissioner* determines that an offence under the *Anti-Racism Code* has been committed, he/she will be required to impose an appropriate sanction on the *Player* or *Player Support Personnel*.
- 7.2 In order to determine the appropriate sanction that is to be imposed in each case, the *Judicial Commissioner* must first consider whether the *Player* or *Player Support Personnel* has previously been found guilty of the same offence under the *Anti-Racism Code* or any predecessor regulations that may have applied (including the *Code of Conduct*).
- 7.3 Once the *Judicial Commissioner* has established whether this is a repeat offence, then he/she shall go on to take into account any other factors that he/she deems relevant and appropriate to the mitigation or aggravation of the nature of the offence (including, without limitation, the nature and frequency of any previous offences under the *Anti-Racism Code* or any predecessor regulations) before determining, in accordance with the following table, what the appropriate sanction(s) should be:

RANGE OF PERMISSIBLE SANCTIONS (FIRST OFFENCE)	RANGE OF PERMISSIBLE SANCTIONS (SECOND OFFENCE)	RANGE OF PERMISSIBLE SANCTIONS (THIRD OFFENCE)
The imposition of between four (4) and eight (8) <i>Suspension Points</i> .	The imposition of between eight (8) <i>Suspension Points</i> and a lifetime's suspension.	The imposition of a suspension of between one (1) year and a lifetime.
AND (in all cases)		
The mandatory requirement to undergo a programme of education/counselling designed to promote the understanding and awareness of issues directly relevant to the offence that the <i>Player</i> or <i>Player Support Personnel</i> has been determined to have committed.		

- 7.4 Where a *Judicial Commissioner* imposes a period of suspension on any *Player* or *Player Support Personnel*, then, unless such period is for a fixed period of time (for example, one year) then, any such period of suspension shall be referenced by *Suspension Points*, which shall carry the following weightings:
- 7.4.1 a *Test Match* or any other *International Match* of at least four days in duration is given a weighting of two (2) *Suspension Points*;
 - 7.4.2 a *One Day International Match* or *Twenty20 International Match* is given a weighting of one (1) *Suspension Point*; and
 - 7.4.3 all other *International Matches* are given a weighting of one (1) *Suspension Point*.
- 7.5 Where *Suspension Points* are imposed against a *Player* or *Player Support Personnel*, then such *Suspension Points* will be applied in accordance with the following principles:
- 7.5.1 the *Judicial Commissioner* shall have regard to the *Player's* or *Player Support Personnel's* participation in the various formats of *International Matches* over the previous two years in order to determine (to the best of his/her ability) which of the forthcoming *International Matches* the *Player* is most likely to participate in or the *Player Support Personnel* is most likely to assist the participation of a *Player* in;
 - 7.5.2 where necessary, the *Judicial Commissioner* shall be entitled to consult with the ICC in order to make a determination as to which of the forthcoming *International Matches* the *Player* is most likely to participate in or the *Player Support Personnel* is most likely to assist the participation of a *Player* in;
 - 7.5.3 in so far as is reasonably possible, the *Judicial Commissioner* shall apply the *Suspension Points* to the subsequent *International Matches* in which the *Player* is most likely to participate in or the *Player Support Personnel* is most likely to assist the participation of a *Player* in, on a chronological basis immediately following the announcement of the decision;
 - 7.5.4 where a *Player* or *Player Support Personnel* has his/her *Suspension Points* applied to an *International Match* that is subsequently cancelled, postponed or otherwise abandoned prior to the actual day on which it is scheduled to take place, then such *Suspension Points* must be reallocated to the next subsequent *International Matches* in which the *Player* is most likely to participate in or the *Player Support Personnel* is most likely to assist the participation of a *Player* in. Where an *International Match* is cancelled, postponed or otherwise abandoned at any time on the actual day on which it is scheduled to take place, then the *Suspension Points* will remain allocated to that *International Match*, irrespective of such cancellation, postponement or abandonment.

Examples of the Application of Suspension Points:

- 1 *Where a Player's playing history suggests that he/she is most likely to represent his National Cricket Federation in Test Matches only, then the Suspension Points shall be applied to his/her future participation in Test Matches only, so that six (6) Suspension Points would be applied to the three (3) Test Matches immediately following the announcement of the decision, notwithstanding that the National Cricket Federation might be participating in intervening One Day International Matches and/or Twenty20 International Matches.*
- 2 *Where a Player's playing history suggests that he/she is likely to be selected to represent his National Cricket Federation in all formats of International Matches, then the Suspension Points shall be applied to his/her future participation in all International Matches in the sequential order in which such International Matches take place immediately following the announcement of the decision. The examples set out below, would apply to the following chronological list of potential playing fixtures:*
 - *Code of Conduct decision*
 - *One-Day International Match - weighting 1 Suspension Point ('Match A')*
 - *One-Day International Match - weighting 1 Suspension Point ('Match B')*
 - *Test Match - weighting 2 Suspension Point ('Match C')*
 - *Test Match weighting 2 Suspension Point ('Match D')*
 - *Twenty20 International Match - weighting 1 Suspension Point ('Match E')*
 - *Twenty20 International Match - weighting 1 Suspension Point ('Match F')*
 - a) *One (1) Suspension Point would be applied to Match A;*
 - b) *Two (2) Suspension Points would be applied to Matches A and B;*
 - c) *Three (3) Suspension Points would be applied to Matches A, B and E;*
 - d) *Four (4) Suspension Point would be applied to Match A, B and C;*
 - e) *Five (5) Suspension Points would be applied to Matches A, B, C and E;*
 - f) *Six (6) Suspension Points would be applied to Matches A, B, C and D;*
 - g) *Seven (7) Suspension Points would be applied to Matches A, B, C, D and E;*
 - h) *Eight (8) Suspension Points would be applied to Matches A, B, C, D, E and F.*

- 7.6** For the avoidance of any doubt:
- 7.6.1 the *Judicial Commissioner* will have no jurisdiction to adjust, reverse or amend the results of any *International Match*;
 - 7.6.2 where a *Player* or *Player Support Personnel* is found guilty of committing two separate *Anti-Racism Code* offences that do not relate to the same incident or set of circumstances arising during an *International Match* and sanctioned separately for each offence, then any sanctions should run cumulatively (and not concurrently);
 - 7.6.3 where a *Player* or *Player Support Personnel* is found guilty of committing two *Anti-Racism Code* offences in relation to the same incident or set of circumstances during an *International Match* and sanctioned separately, then any sanctions imposed should run concurrently (and not cumulatively); and
 - 7.6.4 nothing in this *Anti-Racism Code* shall permit plea bargaining in relation to any alleged offence committed under this *Anti-Racism Code*.
- 7.7** Where a *Player* or *Player Support Personnel* has had *Suspension Points* imposed against him/her or has been suspended for a fixed period of time, he/she may not play, coach or otherwise participate or be involved in any capacity in the *International Match(es)* which: (a) are covered by the application of his/her *Suspension Points* as determined in accordance with Article 7.5; or (b) take place during the fixed period of his/her suspension.
- 7.5** Once any period of suspension has expired, the *Player* or *Player Support Personnel* will automatically become re-eligible to participate (in the case of a *Player*) or assist a *Player's* participation (in the case of a *Player Support Personnel*) in *International Matches* provided that he/she has first; (a) completed the official programme of education/counselling to the reasonable satisfaction of the relevant programme organiser or demonstrated that he/she continues to fully participate in such programme; and (b) satisfied, in full, any award of costs made against him/her by any *Appeal Panel* pursuant to Article 8.3.5.

ARTICLE 8 - APPEALS

- 8.1** Decisions made under the *Anti-Racism Code* by a *Judicial Commissioner* may be challenged solely by appeal as set out in Article 8. Such decisions shall remain in effect while under appeal unless any *Appeal Panel* properly convened to hear the appeal orders otherwise.
- 8.2** The only parties who may appeal a decision made under the *Anti-Racism Code* shall be: (a) the *Player* or *Player Support Personnel* found guilty of the offence; and (b) the ICC's *Chief Executive Officer*.
- 8.3** Any notice to appeal under this Article must be lodged with the ICC's *Head of Legal* within seven (7) days of receipt of the written decision of the *Judicial Commissioner*. In all cases, a copy of such notice will also be provided to the CEO of the *National Cricket Federation* to which the *Player* or *Player Support Personnel* is affiliated. Thereafter, the following will apply:
- 8.3.1 Within forty-eight (48) hours of receipt of a notice to appeal: (a) the ICC's *Head of Legal* will appoint three members of the ICC's *Code of Conduct Commission* each of whom are (unless otherwise agreed between the parties) from a country other than those participating in the relevant *International Match* to sit as the *Appeal Panel* to hear the appeal; and (b) the *Judicial Commissioner* will provide a written statement to the ICC's *Head of Legal* setting out any relevant facts (to be copied to the *Player* or *Player Support Personnel*).

- 8.3.2 The provisions of Articles 5.1.2 to 5.1.14, applicable to proceedings before the *Judicial Commissioner*, shall apply *mutatis mutandis* (ie with changes deemed to have been made as required to reflect the different context) to appeal hearings before the *Appeal Panel*.
- 8.3.3 The *Appeal Panel* shall hear and determine all issues arising from any matter which is appealed to it pursuant to this Article on a *de novo* basis, ie it shall hear the matter over again, from the beginning, without being bound in any way by the decision being appealed. For the avoidance of doubt, the *Appeal Panel* shall have the power to increase or decrease, amend or otherwise substitute a new decision on the appropriateness (or otherwise) of the sanction imposed at first instance, provided that any new sanction must be within the permitted range of sanctions set out in the table in Article 7.3.
- 8.3.4 Appeal hearings pursuant to this Article 8 should be completed expeditiously. Save where all parties agree or fairness requires otherwise, the appeal hearing shall be commenced no later than thirty (30) days after the appointment of the *Appeal Panel*.
- 8.3.5 The *Appeal Panel* shall have the power to order some or all of the costs of the appeal proceedings (including the costs of holding the hearing, any interpretation costs, the legal and/or travel/accommodation costs of the *Appeal Panel* and/or any other relevant parties) to be paid by the appealing party if it considers that such party has acted, spuriously, frivolously or otherwise in bad faith.
- 8.3.6 Any decision made by the *Appeal Panel* under this Article 8, shall be the full, final and complete disposition of the matter and will be binding on all parties.

ARTICLE 9 - RECOGNITION OF DECISIONS

- 9.1 Any hearing results or other final adjudications under the *Anti-Racism Code* shall be recognised and respected by the ICC and its *National Cricket Federations* automatically upon receipt of notice of the same, without the need for any further formality. Each of the ICC and its *National Cricket Federations* shall take all steps legally available to it to enforce and give effect to such decisions.
- 9.2 It shall be a condition of membership of the ICC that all *National Cricket Federations* shall comply with the *Anti-Racism Code*.

ARTICLE 10 - AMENDMENT AND INTERPRETATION OF THE ANTI-RACISM CODE

- 10.1 The *Anti-Racism Code* may be amended from time to time by the Executive Board of the ICC, with such amendments coming into effect on the date specified by the ICC.
- 10.2 The *Anti-Racism Code* shall be interpreted as an independent and autonomous text and not by reference to existing law or statutes of any *National Cricket Federation* or government.
- 10.3 The headings used for the various Articles of the *Anti-Racism Code* are for the purpose of guidance only and shall not be deemed to be part of the substance of the *Anti-Racism Code* or to inform or affect in any way the language of the provisions to which they refer.

- 10.4 The *Anti-Racism Code* shall come into full force and effect on 6 October 2009 (the '**Effective Date**'). It shall not apply retrospectively to matters pending before the *Effective Date*; provided, however, that any case pending prior to the *Effective Date*, or brought after the *Effective Date* but based on an offence that is alleged to have occurred before the *Effective Date*, shall be governed by the predecessor version of the *Anti-Racism Code* in force at the time of the alleged offence, subject to any application of the principle of *lex mitior* by the hearing panel determining the case.
- 10.5 If any Article or provision of this *Anti-Racism Code* is held invalid, unenforceable or illegal for any reason, the *Anti-Racism Code* shall remain otherwise in full force apart from such Article or provision which shall be deemed deleted insofar as it is invalid, unenforceable or illegal.
- 10.6 The *Anti-Racism Code* is governed by and shall be construed in accordance with English law. Strictly without prejudice to the arbitration provisions of Articles 5 and 8 of the *Anti-Racism Code*, disputes relating to the *Anti-Racism Code* shall be subject to the exclusive jurisdiction of the English courts.

APPENDIX 1 - DEFINITIONS

Appeal Panel. A panel of three persons appointed by the ICC from the members of the *ICC Code of Conduct Commission*, to perform the functions assigned to the *Appeal Panel* under the *Anti-Racism Code*. Each member of the *Appeal Panel* shall be independent of the ICC, which may provide reasonable compensation and reimbursement of expenses to such members.

Code of Conduct. The ICC's Code of Conduct for Players and Player Support Personnel, as amended from time to time.

Conciliator. An independent expert, trained in mediation and, where possible, with specialist expertise in the area of race relations (or such other expertise as may be relevant to the nature of any alleged offence), who is appointed by the ICC to perform the functions assigned to the *Conciliator* under the *Anti-Racism Code*.

Effective Date. As defined in Article 10.4.

ICC. The International Cricket Council or its designee.

ICC's Anti-Racism Policy for Members. The ICC's Anti-Racism Policy for Members (a copy of which is set out in the *ICC's Operating Manual*), as amended from time to time.

ICC's Chief Executive Officer. The person appointed by the ICC from time to time to act as its Chief Executive Officer (or his/her designee).

ICC Code of Conduct Commission. An official committee of the ICC established, amongst other things, to provide independent enquiries, investigations and rulings in relation to matters brought to its attention pursuant to the *Code of Conduct* and/or *Anti-Racism Code*. Each member of the *ICC Code of Conduct Commission* shall be independent of the ICC, which may provide reasonable compensation and reimbursement of expenses to such members.

ICC Code of Conduct for Umpires and Referees. The ICC's Code of Conduct for Umpires and Referees, in force from time to time.

ICC Events. Each of the following: (a) the ICC Cricket World Cup; (b) the ICC World Twenty20; (c) the ICC Champions Trophy; (d) the ICC World Cricket League Divisions 1-8 (inclusive), together with any regional qualifying events thereto; (e) the ICC Women's Cricket World Cup; (f) the ICC Under 19 Cricket World Cup; (g) the ICC World Cup Qualifying Tournament; (h) the ICC Women's Cricket World Cup Qualifying Tournament, together with any regional qualifying events thereto; (i) the ICC World Twenty20 Qualifying Tournament; (j) the ICC Under 19 Cricket World Cup Qualifying Tournament, together with any regional qualifying events thereto; (k) the ICC Intercontinental Cup and Shield; and (l) any other event organised or sanctioned by the ICC from time to time to which the ICC deems it appropriate that the *Anti-Racism Code* should apply.

ICC's Head of Legal. The person appointed by the ICC from time to time to act as Head of its Legal Department (or his/her designee).

ICC's Operating Manual. The ICC's Official Operating Manual in force from time to time.

International Match. Each of the following (in men's and women's cricket): (a) any *Test Match*, *One Day International Match* or *Twenty20 International Match*; (b) any *Match* played as part of an *ICC Event*; (c) any *International Tour Match*; or (d) any other *Match* organised or sanctioned by the ICC from time to time to which the ICC deems it appropriate that the *Anti-Racism Code* should apply.

International Tour Match. Any cricket match of any format and duration in length played between a representative team of a *National Cricket Federation* and any domestic, guest or invitational team.

Judicial Commissioner. The independent person appointed by the ICC from the *ICC Code of Conduct Commission*, to perform the functions assigned to the *Judicial Commissioner* under the *Anti-Racism Code*.

Match. A cricket match of any format and duration in length played between representative teams (male or female) of two *National Cricket Federations* affiliated to the ICC.

Match Referee. The independent person appointed by the ICC (or any other relevant party) as the official match referee for a designated *International Match*, whether such *Match Referee* carries out his/her functions remotely or otherwise. Where a *Match Referee* is not physically present at a particular *Match*, he/she may be assisted in the administrative performance of his/her duties under this *Anti-Racism Code* by any official 'Match Manager' who may be appointed to officiate at such *International Match*.

National Cricket Federation. A national or regional entity which is a member of or is recognised by the ICC as the entity governing the sport of cricket in a country (or collective group of countries associated for cricket purposes).

Notice of Charge. As defined in Article 4.4.

One Day International Match. As defined by Section 33 (ICC Classification of Official Cricket) of the ICC's *Operating Manual*.

Player. Any cricketer who is selected in any playing or touring team or squad that is chosen to represent a *National Cricket Federation* in any *International Match* or series of *International Matches*.

Player Support Personnel. Any coach, trainer, manager, selector, team official, doctor, physiotherapist or any other person employed by, representing or otherwise affiliated to a playing/ touring team or squad that is chosen to represent a *National Cricket Federation* in any *International Match* or series of *International Matches*.

Report. As defined in Article 3.1.

Suspension Points. The weighting points used to determine the period of suspension imposed against any *Player* or *Player Support Personnel* pursuant to Article 7 of the *Anti-Racism Code*.

Team Captain or Vice Captain. The official captain or vice-captain of any team participating in a *Match*.

Team Manager. The official manager of any team participating in a *Match*.

Test Match. As defined by Section 33 (ICC Classification of Official Cricket) of the ICC's *Operating Manual*.

Twenty20 International Match. As defined by Section 33 (ICC Classification of Official Cricket) of the ICC's *Operating Manual*.

Umpire. Any umpire (including a third or other umpires) appointed to officiate in a *Match*.

APPENDIX 2 – EXPEDITED PROCEDURE FOR OFFENCES UNDER THE ANTI-RACISM CODE OCCURRING DURING AN ICC EVENT

Where an offence under the *Anti-Racism Code* is alleged to have occurred during, or in relation to, an *International Match* that is played as part of an *ICC Event* (except the ICC Intercontinental Cup and Shield in which no expedited procedure is to be applied), the provisions of the *Anti-Racism Code* shall apply in full save for the amendments described in this Appendix 2, which are deemed to be made in order to ensure that any matters arising can be dealt with expediently:

ARTICLE 3 - REPORTING AN ALLEGED OFFENCE UNDER THE ANTI-RACISM CODE

- Article 3.2 - 'seven (7) days' is replaced with 'thirty-six (36) hours'.

ARTICLE 4 - NOTIFICATION PROCEDURE

- Article 4.1 - 'five (5) business days' is replaced with 'forty-eight (48) hours'.

ARTICLE 5 - THE DISCIPLINARY PROCEDURE

- Article 5.1 is replaced in its entirety with the following:

5.1 Disciplinary Procedure during an ICC Event

Where a matter proceeds to a hearing under Article 4.5.2 or 4.5.3, then the case shall be referred to a *Judicial Commissioner* for adjudication in accordance with the following procedure:

- 5.1.1 As soon as reasonably possible, the ICC shall appoint one member from the ICC's *Code of Conduct Commission* to sit as the *Judicial Commissioner* to hear the case sitting alone. The appointed member shall be independent of the parties, have had no prior involvement with the case and shall not, unless otherwise agreed between the parties, be from a country participating in the *International Match* during, or in relation to which, the alleged offence was committed.
- 5.1.2 Subject to the discretion of the *Judicial Commissioner* to order otherwise for good cause shown by the *Player* or *Player Support Personnel*, the hearing will take place at the time specified in the *Notice of Charge* (which should, in the absence of exceptional circumstances, be no more than forty-eight (48) hours after receipt by the *Player* or *Player Support Personnel* of the *Notice of Charge*) and in the country in which the alleged offence was committed. For the avoidance of doubt, nothing in this Article 5.1.2 prevents a hearing from being convened at a time during which the *International Match* during which the alleged offence took place, remains in progress.
- 5.1.3 The procedure followed at the hearing shall be at the discretion of the *Judicial Commissioner*, provided that the hearing is conducted in a manner which offers the *Player* or *Player Support Personnel* with a fair and reasonable opportunity to present evidence (including the right to call and to question witnesses by telephone or video-conference where necessary), address the *Judicial Commissioner* and present his/her case. For the avoidance of any doubt, in accordance with Article 6.2, unless the relevant party agrees otherwise, no evidence shall be adduced, given or accepted during any hearing before the *Judicial Commissioner* in relation to anything that may have been said or disclosed during any part of any 'without prejudice' conciliation process carried out pursuant to Article 4.3.

- 5.1.4 The hearing before the *Judicial Commissioner* shall be in English, and certified English translations shall be submitted of any non-English documents put before the *Judicial Commissioner*. The cost of the translation shall be borne by the party offering the document(s). If required by the *Judicial Commissioner* (at his/her discretion), the ICC shall make arrangements to have the hearing recorded or transcribed. If requested by the *Player* or *Player Support Personnel*, the ICC shall also arrange for an interpreter to attend the hearing. Such costs of transcription and interpretation shall be paid by the ICC.
- 5.1.5 Where video evidence of the alleged offence is available at the hearing before the *Judicial Commissioner*, then it may be relied upon by any party, provided that all other parties shall have the right to make such representations in relation to it that they may see fit.
- 5.1.6 Unless exceptional circumstances apply, each of the following individuals must attend any hearing before the *Judicial Commissioner*: (a) the *Player* or *Player Support Personnel* who has been charged with the alleged offence; (b) the person who lodged the *Report* (or, in the case of the ICC's *Chief Executive Officer*, his/her representative/nominee); and (c) a representative of the ICC's Legal Department. Where any such individual has a compelling justification for his/her non-attendance, then they shall be given the opportunity to participate in the hearing before the *Judicial Commissioner* by telephone or video conference (if available). Without prejudice to the *Player* or *Player Support Personnel's* ability to call and to question such witnesses as may be necessary and/or to be represented by such other person of his/her own choosing pursuant to Article 5.1.7, one of the *Captain*, *Vice-Captain* or *Team Manager* of the team that the *Player* or *Player Support Personnel* represents may also attend a hearing before the *Judicial Commissioner* to provide additional support and assistance to the *Player* or *Player Support Personnel*.
- 5.1.7 Each of the individuals described in Article 5.1.6(a) and (b) shall have the right (at his/her or its own expense) to be represented at the hearing before the *Judicial Commissioner* by such representative (including legal counsel) of his/her or its own choosing. Where the person lodging the *Report* is an *Umpire* or *Match Referee* that officiated in the *International Match* in question or the ICC's *Chief Executive Officer*, then such person shall be entitled to be represented prior to, and during, the hearing (if he/she considers necessary) by a representative of the ICC's Legal Department.
- 5.1.8 The non-attendance of the *Player* or *Player Support Personnel* or his/her representative at the hearing, after proper notice of the hearing has been provided, shall not prevent the *Judicial Commissioner* from proceeding with the hearing in his/her absence, whether or not any written submissions are made on his/her behalf.
- 5.1.9 At the end of a hearing, where the *Judicial Commissioner* considers that further evidence is necessary or further time is required to consider the evidence that has been presented, he/she shall adjourn the hearing for an appropriate period of time and make such directions as may be necessary.

5.1.10 Alternatively, at the end of a hearing:

5.1.10.1 brought under Article 4.5.2:

- a) as soon as possible after the conclusion of the hearing (and, in any event, no later than twenty-four (24) hours thereafter), the *Judicial Commissioner* will confirm the *Player* or *Player Support Personnel's* admission that he/she had committed an offence under the *Anti-Racism Code* and announce his/her decision in writing, with reasons, setting out: (a) what sanctions, if any, are to be imposed; (b) the date that any period of suspension shall come into force and effect; and (c) any rights of appeal that may exist pursuant to Article 8.

5.1.10.2 brought under Article 4.5.3 (or where the *Player* or *Player Support Personnel* has failed to respond in a timely fashion to the *Notice of Charge*):

- a) the *Judicial Commissioner* shall adjourn the hearing (for a period of no less than ten (10) minutes and no more than two (2) hours), following which he/she will reconvene the hearing and verbally announce his/her finding as to whether an offence under the *Anti-Racism Code* has been committed;
- b) where the *Judicial Commissioner* determines that an offence under the *Anti-Racism Code* has been committed, the *Player* or *Player Support Personnel* may request a short adjournment (of no more than thirty (30) minutes) to prepare any submissions that he/she might wish to make in relation to the appropriate sanction that ought to be applied; and
- c) as soon as possible after the conclusion of the hearing (and, in any event, no later than twenty-four (24) hours thereafter), the *Judicial Commissioner* will announce his/her decision in writing, with reasons, setting out: (a) the finding as to whether an offence under the *Anti-Racism Code* had been committed; (b) what sanctions, if any, are to be imposed; (c) the date that any period of suspension shall come into force and effect; and (d) any rights of appeal that may exist pursuant to Article 8.

5.1.11 The *Judicial Commissioner* shall have the discretion to announce the substance of his/her decision prior to the issue of the written reasoned decision referred to in Article 5.1.10.

5.1.14 A copy of the written reasoned decision will be provided to the *Player* or *Player Support Personnel*, the CEO of the *Player* or *Player Support Personnel's National Cricket Federation* and the ICC's *Cricket Operations Manager*.

5.1.15 Subject only to the rights of appeal under Article 8, the *Judicial Commissioner's* decision shall be the full, final and complete disposition of the matter and will be binding on all parties.

ARTICLE 8 - APPEALS

- Article 8.3 'seven (7) days' is replaced with 'forty-eight (48) hours'.
- Article 8.3.1 'forty-eight (48) hours' is replaced with 'twenty-four (24) hours'.
- Article 8.3.4 'thirty (30) days' is replaced with 'seventy-two (72) hours'.

ICC **ANTI-DOPING** CODE

ICC ANTI-DOPING CODE

The ICC has a zero-tolerance approach to doping in cricket in support of its continued efforts to: (a) maintain the integrity of the sport of cricket; (b) protect the health and rights of all participants in the sport of cricket; and (c) keep the sport of cricket free from doping.

Consistent with the WADA Code, the ICC's Anti-Doping Code (the '**Code**') ensures cricket plays its part in the global fight against drugs in sport. All international cricketers (as defined in the Code) are bound by the Code and are required to sign a Consent and Agreement form acknowledging that the Code applies to them.

Under the Code, all international cricketers can be subject to both In and Out-of-Competition testing by the ICC any day, anytime, 365 days of the year.

Whilst it remains the responsibility of each National Cricket Federation to educate their own international cricketers in all aspects of anti-doping and to ensure that such cricketers are aware of the Code and that it applies to them, it is ultimately each cricketer's **personal responsibility** to:

- 1 acquaint him/herself, and ensure that each person from whom he/she takes advice (including medical personnel) is acquainted with all of the requirements of the Code;
- 2 know what constitutes an anti-doping rule violation under the Code and what substances and methods have been included on the Prohibited List;
- 3 ensure that anything he/she ingests or uses, as well as any medical treatment he/she receives, does not give rise to an anti-doping rule violation under the Code; and
- 4 make him/herself available upon request for Testing, both In-Competition and Out-of-Competition.
- 5 comply with the ICC's Whereabouts Requirements for Out-of-Competition Testing (a copy of which can be found in the anti-doping section of the ICC's website: **www.icc-cricket.com**) where applicable, including by filing and maintaining accurate and relevant up-to-date information as required.

The full version of the ICC's Anti-Doping Code can be found in the anti-doping section of the ICC's website: **www.icc-cricket.com** and all players are strongly recommended to review the Code in its entirety. In addition, the ICC has also developed numerous guidance notes, educational materials and documentation, all of which are also available on the website.

Finally, if any player, player support personnel or National Cricket Federation has any questions, concerns or comments in relation to any aspect of anti-doping, including the Code, then they should contact the ICC's Anti-Doping team on the following details:

ICC Anti-Doping

Telephone: + 971 4 382 8800 (office hours, + 4 GMT)

Mobile: + 971 50 554 5891 (24 hours)

Fax: + 971 4 340 9336 (dedicated)

E-mail: anti-doping@icc-cricket.com (confidential)

ICC ANTI-CORRUPTION CODE FOR PARTICIPANTS

ICC ANTI-CORRUPTION CODE FOR PARTICIPANTS

	PAGE
Article 1	Introduction, Scope and Application 17.2
Article 2	Offences Under the <i>Anti-Corruption Code</i> 17.4
Article 3	Standard of Proof and Evidence 17.7
Article 4	Investigations and <i>Notice of Charge</i> 17.7
Article 5	The Disciplinary Procedure 17.11
Article 6	Sanctions 17.14
Article 7	Appeals 17.17
Article 8	Public Disclosure and Confidentiality 17.17
Article 9	Recognition of Decisions 17.18
Article 10	Statute of Limitations 17.18
Article 11	Amendment and Interpretation of the <i>Anti-Corruption Code</i> 17.18
Appendix 1	Definitions 17.20

ARTICLE 1 - INTRODUCTION, SCOPE AND APPLICATION

- 1.1 The ICC has adopted this *Anti-Corruption Code* in recognition of the following fundamental sporting imperatives:
 - 1.1.1 All cricket matches are to be contested on a level playing-field, with the outcome to be determined solely by the respective merits of the competing teams and to remain uncertain until the cricket match is completed. This is the essential characteristic that gives sport its unique appeal.
 - 1.1.2 Public confidence in the authenticity and integrity of the sporting contest is therefore vital. If that confidence is undermined, then the very essence of cricket will be shaken to the core. It is the determination to protect that essence of cricket that has led the ICC to adopt the *Anti-Corruption Code*.
 - 1.1.3 Advancing technology and increasing popularity have led to a substantial increase in the amount, and the sophistication, of betting on cricket matches. The development of new betting products, including spread-betting and betting exchanges, as well as internet and phone accounts that allow people to place a bet at any time and from any place, even after a cricket match has started, have all increased the potential for the development of corrupt betting practices. That, in turn, increases the risk that attempts will be made to involve participants in such practices. Even where that risk is more theoretical than practical, its consequence is to create a perception that the integrity of the sport is under threat.
 - 1.1.4 Furthermore, it is of the nature of this type of misconduct that it is carried out under cover and in secret, thereby creating significant challenges for the ICC in the enforcement of rules of conduct. As a consequence, the ICC needs to be empowered to seek information from and share information with competent authorities and other relevant third parties, and to require *Participants* to cooperate fully with all investigations and requests for information.
 - 1.1.5 The ICC is committed to taking every step in its power to prevent corrupt betting practices undermining the integrity of the sport of cricket, including any efforts to influence improperly the outcome or any other aspect of an *International Match* or *ICC Event*.
- 1.2 The *Anti-Corruption Code* is to be interpreted and applied by reference to the fundamental sporting imperatives described in Article 1.1. This includes but is not limited to cases where an issue arises that is not expressly addressed in the *Anti-Corruption Code*. Such interpretation and application shall take precedence over any strict legal or technical interpretations of the *Anti-Corruption Code* that may otherwise be proposed.
- 1.3 All *Participants* are automatically bound by and required to comply with all of the provisions of the *Anti-Corruption Code*. Accordingly, by their participation (in the case of a *Player*) or assistance in a *Player's* participation (in the case of a *Player Support Personnel*), or appointment to officiate (in the case of an *Umpire* or *Match Referee*) or appointment to support an *Umpire* or *Match Referee* (in the case of an *Umpire Support Personnel*) in an *International Match*, such *Participants* shall be deemed to have agreed:
 - 1.3.1 for purposes of applicable data protection and other laws and for all other purposes, to have consented to the collection, processing, disclosure and use of information relating to him/herself and his/her activities, including personal information relating to him/herself and his/her activities, to the extent expressly permitted under the terms of the *Anti-Corruption Code*, and shall confirm such agreement in writing upon demand;

- 1.3.2 that it is their personal responsibility to familiarise themselves with all of the requirements of the *Anti-Corruption Code*, including what conduct constitutes an offence under the *Anti-Corruption Code*, and to comply with those requirements;
 - 1.3.3 to submit to the authority of the ICC (including as delegated to any member of the ACSU) to adopt, apply, monitor and enforce the *Anti-Corruption Code*;
 - 1.3.4 to submit to the exclusive jurisdiction of any *Anti-Corruption Tribunal* convened under the *Anti-Corruption Code* to hear and determine charges brought by the ICC and/or related issues under the *Anti-Corruption Code*;
 - 1.3.5 to submit to the exclusive jurisdiction of any CAS panel convened under the *Anti-Corruption Code* to hear and determine appeals made pursuant to the *Anti-Corruption Code*; and
 - 1.3.6 not to bring any proceedings in any court or other forum that are inconsistent with the foregoing submissions to the jurisdiction of the *Anti-Corruption Tribunal* and the CAS.
- 1.4 Each *Participant* shall continue to be bound by and required to comply with the *Anti-Corruption Code* until he/she has not participated (in the case of a *Player*) or assisted in a *Player's* participation (in the case of a *Player Support Personnel*) or officiated (in the case of an *Umpire* or *Match Referee*) or been appointed to support an *Umpire* or *Match Referee* (in the case of an *Umpire Support Personnel*) in an *International Match* for a period of twelve (12) months. The ICC shall continue to have jurisdiction over him/her under the *Anti-Corruption Code* thereafter in respect of matters taking place prior to that point.
 - 1.5 Without prejudice to Articles 1.3 and 1.4, the ICC (through the ACSU) and the *National Cricket Federations* shall be responsible for promoting *Anti-Corruption Code* awareness and education amongst all *Participants*.
 - 1.6 It is acknowledged that certain *Participants* may also be subject to separate anti-corruption rules of *National Cricket Federations* applicable at a national level, and that the same conduct of such *Participants* may implicate not only the *Anti-Corruption Code* but also such other anti-corruption rules that may apply. For the avoidance of any doubt, *Participants* acknowledge and agree that: (a) the *Anti-Corruption Code* is not intended to limit the responsibilities of any *Participant* under such other rules; and (b) nothing in such other rules shall be capable of removing, superseding or amending in any way the jurisdiction of the *Anti-Corruption Tribunal* or CAS panel to determine matters properly arising under the *Anti-Corruption Code*.
 - 1.7 The conduct prohibited under the *Anti-Corruption Code* may also be a criminal offence and/or a breach of other applicable laws or regulations. The *Anti-Corruption Code* is intended to supplement such laws and regulations with further rules of professional conduct for those involved in the sport of cricket. It is not intended, and should not be interpreted, construed or applied, to prejudice or undermine in any way the application of such laws and regulations. *Participants* must comply with all applicable laws and regulations at all times.

- 1.8 For the avoidance of any doubt:
- 1.8.1 nothing in this *Anti-Corruption Code* is intended in any way to replace or amend the ICC's *Policy on Member Associations with Betting Companies* which shall remain in full force and effect and to which the ICC and all *National Cricket Federations* agree to be bound at all times;
 - 1.8.2 nothing in this *Anti-Corruption Code* is intended in any way to replace or amend the ICC's *Minimum Standards for Players and Match Officials Area* which shall remain in full force and effect and to which all *National Cricket Federations, Participants* agree to be bound at all times; and
 - 1.8.3 nothing in this *Anti-Corruption Code* is intended in any way to replace or amend the ICC's *Clothing and Equipment Rules and Regulations* which shall remain in full force and effect and to which all *National Cricket Federations, Participants* agree to be bound at all times.
- 1.9 Unless otherwise indicated, references in the *Anti-Corruption Code* to Articles and Appendices are to articles and appendices of the *Anti-Corruption Code*. Words in italicised text in the *Anti-Corruption Code* are defined terms and their definitions are set out in Appendix 1.

ARTICLE 2 - OFFENCES UNDER THE ANTI-CORRUPTION CODE

The conduct described in Articles 2.1 – 2.4, if committed by a *Participant*, shall amount to an offence by such *Participant* under the *Anti-Corruption Code*:

2.1 Corruption:

- 2.1.1 Fixing or contriving in any way or otherwise influencing improperly, or being a party to any effort to fix or contrive in any way or otherwise influence improperly, the result, progress, conduct or any other aspect of any *International Match* or *ICC Event*.

Note: *It shall not be an offence under Article 2.1.1 to manipulate International Matches for strategic or tactical reasons (such as where a Player performs in a certain manner to enable his team to lose a pool Match in an ICC Event in order to affect the standings of other teams in that ICC Event). Instead, such conduct is prohibited under the ICC's Code of Conduct for Players and Player Support Personnel and must be dealt with according to the procedures set out therein.*

- 2.1.2 Seeking, accepting, offering or agreeing to accept any bribe or other Reward to fix or to contrive in any way or otherwise to influence improperly the result, progress, conduct or any other aspect of any *International Match* or *ICC Event*.
- 2.1.3 Failing, for Reward, to perform to one's abilities in an *International Match*.
- 2.1.4 Soliciting, inducing, enticing, instructing, persuading, encouraging or facilitating any *Participant* to breach any of the foregoing provisions of this Article 2.1.

2.2 Betting:

- 2.2.1 Placing, accepting, laying or otherwise entering into any *Bet* with any other party (whether individual, company or otherwise) in relation to the result, progress, conduct or any other aspect of any *International Match* or *ICC Event*.

- 2.2.2 Soliciting, inducing, enticing, instructing, persuading, encouraging, facilitating or authorising any other party to enter into a *Bet* for the direct or indirect benefit of the *Participant* in relation to the result, progress, conduct or any other aspect of any *International Match* or *ICC Event*.
- 2.2.3 Ensuring the occurrence of a particular incident in an *International Match* or *ICC Event*, which occurrence is to the *Participant's* knowledge the subject of a *Bet* and for which he/she expects to receive or has received any *Reward*.

2.3 Misuse of *Inside Information*:

- 2.3.1 Using, for *Betting* purposes, any *Inside Information*.
- 2.3.2 Disclosing *Inside Information* to any person (with or without *Reward*) before or during any *International Match* or *ICC Event* where the *Participant* might reasonably be expected to know that disclosure of such information in such circumstances could be used in relation to *Betting*.

Note: Any potential offence under this Article will be considered on its own set of facts and the particular circumstances surrounding any relevant disclosure. For example, it may be an offence under this clause to disclose *Inside Information*: (a) to journalists or other members of the media; and/or (b) on social networking websites where the *Participant* might reasonably be expected to know that disclosure of such information in such circumstances could be used in relation to *Betting*. However, nothing in this Article is intended to prohibit any such disclosure made within a personal relationship (such as to a member of a family) where it is reasonable for the *Participant* to expect that such information can be disclosed in confidence and without being subsequently used for *Betting*.

- 2.3.3 Soliciting, inducing, enticing, persuading, encouraging or facilitating any *Participant* to breach any of the foregoing provisions of this Article 2.3.

2.4 General:

- 2.4.1 Providing or receiving any gift, payment or other benefit (whether of a monetary value or otherwise) in circumstances that the *Participant* might reasonably have expected could bring him/her or the sport of cricket into disrepute.

Note: This Article is only intended to catch 'disrepute' that, when considered in all of the relevant circumstances, relates (directly or indirectly) to any of the underlying imperatives of and conduct prohibited by this Anti-Corruption Code (including as described in Article 1.1).

Where any substantial gift, payment or other benefit is received by any *Participant* from an unknown person or organisation and/or for no apparent reason, such *Participant* is advised, pursuant to the ACSU education programme to report such receipt to his/her National Cricket Federation and/or to the ACSU. Where such *Participant* does not make such a report, then that is likely to constitute strong evidence (which the *Participant* will have the opportunity of rebutting) of the commission of this offence.

- 2.4.2 Failing to disclose to the ACSU (without undue delay) full details of any approaches or invitations received by the *Participant* to engage in conduct that would amount to a breach of the *Anti-Corruption Code*.

- 2.4.3 Failing to disclose to the ACSU (without undue delay) full details of any incident, fact, or matter that comes to the attention of a *Participant* that may evidence an offence under the *Anti-Corruption Code* by a third party, including (without limitation) approaches or invitations that have been received by any other party to engage in conduct that would amount to a breach of the *Anti-Corruption Code*.

Note: All Participants shall have a continuing obligation to report any new incident, fact, or matter that may evidence an offence under the *Anti-Corruption Code* to the ACSU, even if the Participant's prior knowledge has already been reported.

- 2.4.4 Failing, without compelling justification, to cooperate with any reasonable investigation carried out by the ACSU in relation to possible breaches of the *Anti-Corruption Code*, including failure to provide any information and/or documentation requested by the ACSU (whether as part of a formal *Demand* pursuant to Article 4.3 or otherwise) that may be relevant to such investigation.
- 2.5 For the purposes of this Article 2:
- 2.5.1 Any attempt by a *Participant*, or any agreement by a *Participant* with any other person, to act in a manner that would culminate in the commission of an offence under the *Anti-Corruption Code*, shall be treated as if an offence had been committed, whether or not such attempt or agreement in fact resulted in such offence. However, there shall be no offence under the *Anti-Corruption Code* where the *Participant* renounces the attempt or agreement prior to it being discovered by a third party not involved in the attempt or agreement.
- 2.5.2 A *Participant* who authorises, causes, knowingly assists, encourages, aids, abets, covers up or is otherwise complicit in any acts or omissions of the type described in Articles 2.1 – 2.4 committed by his/her coach, trainer, manager, agent, family member, guest or other affiliate or associate shall be treated as having committed such acts or omissions himself and shall be liable accordingly under the *Anti-Corruption Code*.
- 2.6 The following are not relevant to the determination of an offence under the *Anti-Corruption Code* (although they may be relevant to the issue of the sanction to be imposed under Article 6 in the event that it is determined that an offence has been committed):
- 2.6.1 Whether or not the *Player* him/herself was participating, or a *Player* assisted by the *Player Support Personnel* was participating, or the *Umpire* or *Match Referee* was officiating, or the *Umpire Support Personnel* was appointed to support an *Umpire* or *Match Referee* in the specific *International Match* or *ICC Event* in question.
- 2.6.2 The nature or outcome of any *Bet(s)* in issue.
- 2.6.3 The outcome of the *International Match(es)* or *ICC Event(s)* on which such *Bet* was made.
- 2.6.4 Whether or not the *Participant's* efforts or performance (if any) in the *International Match(es)* or *ICC Event(s)* in issue were (or could be expected to be) affected by the acts or omissions in question.
- 2.6.5 Whether or not any of the results in the *International Match(es)* or *ICC Event(s)* in issue were (or could be expected to be) affected by the act or omissions in question.

- 2.7 It shall be a valid defence to a charge of an offence under the *Anti-Corruption Code* to prove, on the balance of probabilities, that the alleged offence was committed (and that it was not reported to the ACSU thereafter) due to the *Participant's* honest and reasonable belief that there was a serious threat to his/her life or safety or to the life or safety of any other person.

ARTICLE 3 - STANDARD OF PROOF AND EVIDENCE

- 3.1 Unless otherwise described herein, the burden of proof shall be on the ACSU's *General Manager* and the standard of proof in all cases brought under the *Anti-Corruption Code* shall be whether the *Anti-Corruption Tribunal* is comfortably satisfied, bearing in mind the seriousness of the allegation that is being made, that the alleged offence has been committed. This standard of proof in all cases shall be determined on a sliding scale from, at a minimum, a mere balance of probability (for the least serious offences) up to proof beyond a reasonable doubt (for the most serious offences).
- 3.2 The *Anti-Corruption Tribunal* shall not be bound by judicial rules governing the admissibility of evidence. Instead, facts relating to an offence under the *Anti-Corruption Code* may be established by any reliable means, including admissions. The following rules of proof shall be applicable at the hearing:
- 3.2.1 The *Anti-Corruption Tribunal* shall have discretion to accept any facts established by a decision of a court or professional disciplinary tribunal of competent jurisdiction which is not the subject of a pending appeal as irrefutable evidence against the *Participant* to whom the decision pertained of those facts, unless the *Participant* establishes that the decision violated principles of natural justice.
- 3.2.2 The *Anti-Corruption Tribunal* may draw an inference adverse to the *Participant* who is asserted to have committed an offence under the *Anti-Corruption Code* based on his/her refusal, without compelling justification, after a request made in a reasonable time in advance of the hearing, to appear at the hearing (either in person or telephonically as directed by the *Anti-Corruption Tribunal*) and to answer any relevant questions.

ARTICLE 4 - INVESTIGATIONS AND NOTICE OF CHARGE

- 4.1 Any allegation or suspicion of a breach of the *Anti-Corruption Code*, whatever the source, shall be referred to the ACSU *General Manager* for investigation and possible charge in accordance with Article 4.5.
- 4.2 The ACSU may conduct investigations into the activities of any *Participant* that it believes may have committed an offence under the *Anti-Corruption Code*. Such investigations may be conducted in conjunction with, and/or information obtained in such investigations may be shared with *National Cricket Federations* and/or other relevant authorities (including criminal, administrative, professional and/or judicial authorities) and all *Participants* and *National Cricket Federations* must cooperate fully with such investigations. The ACSU shall have discretion, where it deems appropriate, to stay its own investigation pending the outcome of investigations being conducted by other *National Cricket Federations* and/or other relevant authorities.

- 4.3 As part of any such investigation, if the *ACSU General Manager* reasonably suspects that a *Participant* (or a third party whose actions may be imputed to the *Participant*) has committed an offence under the *Anti-Corruption Code*, he/she may make a written demand to such *Participant* (a '**Demand**') to furnish to him/her any information that is reasonably related to the alleged offence, including, without limitation: (a) copies or access to all records relating to the alleged breach (such as telephone records, Internet services records and/or other records stored on computer hard drives or other information storage equipment); and/or (b) a written statement made by the *Participant* setting out in detail all of the facts and circumstances of which the *Participant* is aware with respect to the alleged offence. Provided that any such Demand has been issued in accordance with this Article, and subject to any applicable principles of national law, the *Participant* shall cooperate fully with such Demand, including by furnishing such information within such reasonable period of time as may be determined by the *ACSU General Manager*, which in any event, should be no earlier than fourteen days of the *Participant's* receipt of the Demand. Where appropriate, the *Participant* may seek an extension of such deadline by providing the *ACSU's General Manager* with cogent reasons to support an extension, provided that the decision to grant or deny such extension shall be at the ultimate discretion of the *ACSU's General Manager*, acting reasonably at all times.
- 4.4 Any information furnished to the *ACSU's General Manager* (whether as part of an investigation or pursuant to a specific Demand) will not be used for any reason other than pursuant to the *Anti-Corruption Code* and will be kept strictly confidential except when:
- 4.4.1 it becomes necessary to disclose such information in support of a charge of breach of the *Anti-Corruption Code*;
 - 4.4.2 such information is required to be disclosed by any applicable law;
 - 4.4.3 such information is already published or a matter of public record, readily acquired by an interested member of the public, or disclosed according to the rules and regulations governing the relevant *International Match* or *ICC Event*; and/or
 - 4.4.4 it becomes necessary to disclose such information where information gathered under the *Anti-Corruption Code* may also amount to or evidence infringements of other applicable laws or regulations, the *ICC* may conduct investigations in respect thereto, in conjunction with, and/or may share information relating thereto with, the competent authorities (including any applicable police, taxation, fraud, criminal intelligence or other authorities), whether pursuant to formal information-sharing information agreements with such authorities or otherwise.
- 4.5 Where, following an investigation, the *ACSU General Manager* (in consultation with the *ICC's Chief Executive Officer* and the *ICC's Head of Legal*) determines that there is a case to answer under Article 2, then the *Participant* shall be sent written notice of the following, copied to the CEO of the *National Cricket Federation* to which he/she is affiliated (the '**Notice of Charge**')
- 4.5.1 that the *Participant* has a case to answer under Article 2;
 - 4.5.2 the specific offence(s) that the *Participant* is alleged to have committed;
 - 4.5.3 details of the alleged acts and/or omissions relied upon in support of the charge;

- 4.5.4 the range of sanctions applicable under the *Anti-Corruption Code* if it is established that the *Participant* has committed the offence(s) charged;
- 4.5.5 (where applicable) the matters relating to *Provisional Suspension* specified at Article 4.6; and
- 4.5.6 the matters relating to responding to a *Notice of Charge* specified at Article 4.7.

4.6 *Provisional Suspension*

- 4.6.1 Where the *ACSU General Manager* decides to charge a *Participant* with an offence under the *Anti-Corruption Code*, he/she (in consultation with the *ICC's Chief Executive Officer* and the *ICC's Head of Legal*) shall have the discretion, in circumstances where he/she considers that the integrity of the sport could otherwise be seriously undermined, to *Provisionally Suspend* the *Participant* pending the *Anti-Corruption Tribunal's* determination of whether he/she has committed an offence. A copy of any written notice to *Provisionally Suspend* the *Participant* will, at the same time, be sent by the *ICC* to the *Participant's* relevant *National Cricket Federation*.
- 4.6.2 Where a *Provisional Suspension* is imposed, the *Participant* shall be given an opportunity to contest such *Provisional Suspension* in a *Provisional Hearing* taking place either before the imposition of the *Provisional Suspension* or on a timely basis after its imposition. At any such *Provisional Hearing*, it shall be the burden of the *ACSU's General Manager* to establish: (a) that there is a strong, arguable case against the *Participant* on the charge(s) that have been made against him/her; and (b) that, in such circumstances, the integrity of the sport could be seriously undermined if a *Provisional Suspension* was not imposed against him/her. The Chairman of the *ICC Code of Conduct Commission* shall have the discretion to determine the appropriate procedure to be followed at any such *Provisional Hearing*, provided that the *Participant* is afforded a fair and reasonable opportunity to present evidence, address the Chairman and present his/her case. Notice of any decision made at a *Provisional Hearing* will be sent by the *ICC* to the *Participant's* relevant *National Cricket Federation* as soon as such decision has been made.
- 4.6.3 Where a full hearing under Article 5 has not been convened within three (3) months of the imposition of a *Provisional Suspension*, the *Participant* shall be entitled to apply to the Chairman of the *ICC Code of Conduct Commission* (sitting alone) to lift the imposition of the *Provisional Suspension*. It shall be the burden of the *ACSU's General Manager* to establish that there remains (a) a strong, arguable case against the *Participant* on the charge(s) that have been made against him/her; and (b) a risk that the integrity of the sport could be seriously undermined if the *Provisional Suspension* was lifted. The Chairman of the *ICC Code of Conduct Commission* shall have discretion to determine such application as he considers appropriate (including whether to convene a hearing or to determine the matter on the papers), provided that the *Participant* is afforded a fair and reasonable opportunity to present evidence, address the Chairman and present his/her case.

4.6.4 No *Participant* who is the subject of any *Provisional Suspension* may, during the period of any *Provisional Suspension*, play, coach or otherwise participate or be involved in any capacity in any *International Match* or (any other kind of *Match*, function, event or activity (other than authorised anti-corruption education or rehabilitation programs) that is authorised, organised, sanctioned, recognised or supported in any way by the ICC, a *National Cricket Federation* or any member of a *National Cricket Federation*. *National Cricket Federations* shall take all reasonable steps within their powers to give effect to this Article 4.6.4 where they have the jurisdiction to do so.

4.7 Responding to a *Notice of Charge*

4.7.1 The *Notice of Charge* shall also specify that, if the *Participant* wishes to exercise his/her right to a hearing before the *Anti-Corruption Tribunal*, he/she must submit a written request for such a hearing so that it is received by the *ACSU General Manager* as soon as possible, but in any event within fourteen (14) days of the receipt by the *Participant* of the *Notice of Charge*. The request must also state how the *Participant* responds to the charge(s) and must explain (in summary form) the basis for such response.

4.7.2 If the *Participant* fails to file a written request for a hearing before the *Anti-Corruption Tribunal* by the deadline specified in Article 4.7.1 (or by any extended deadline that the *ACSU's General Manager* deems appropriate), then he/she shall be deemed to have:

4.7.2.1 waived his/her entitlement to a hearing;

4.7.2.2 admitted that he/she has committed the offence(s) under the *Anti-Corruption Code* specified in the *Notice of Charge*; and

4.7.2.3 acceded to the range of applicable sanctions specified in the *Notice of Charge*.

In such circumstances, a hearing before the *Anti-Corruption Tribunal* shall not be required. Instead, the ICC's *Chief Executive Officer* (in consultation with ICC's *Head of Legal*) shall promptly issue a public decision confirming the offence(s) under the *Anti-Corruption Code* specified in the *Notice of Charge* and the imposition of an applicable sanction within the range specified in the *Notice of Charge*. Before issuing that public decision, the ICC's *Chief Executive Officer* will provide written notice of that decision to the *Participant's* relevant *National Cricket Federation*.

4.7.3 Where the *Participant* does request a hearing in accordance with Article 4.7.1, the matter shall proceed to a hearing in accordance with Article 5.

ARTICLE 5 - THE DISCIPLINARY PROCEDURE

5.1 Hearings under the *Anti-Corruption Code*

- 5.1.1 Where the *ICC* alleges that a *Participant* has committed an offence under the *Anti-Corruption Code*, and the *Participant* denies the allegation, and/or disputes the sanctions to be imposed for such offence under the *Anti-Corruption Code*, then the matter shall be referred to the Chairman of the *ICC Code of Conduct Commission*.
- 5.1.2 The Chairman of the *ICC Code of Conduct Commission* shall appoint three members from the *ICC Code of Conduct Commission* (which may include the Chairman) to form the *Anti-Corruption Tribunal* to hear each case. One member of the *Anti-Corruption Tribunal*, who shall be a lawyer, shall sit as the Chairman of the *Anti-Corruption Tribunal*. The appointed members shall be independent of the parties, have had no prior involvement with the case and shall not, unless otherwise agreed between the parties, be from the same country as the *Participant* alleged to have breached the *Anti-Corruption Code*.
- 5.1.3 The Chairman of the *Anti-Corruption Tribunal* shall convene a preliminary hearing with the *ICC* and its legal representatives, together with the *Participant* and his/her legal representatives (if any). At the discretion of the Chairman, a representative of the *Participant's* relevant *National Cricket Federation* may also attend any such hearing (but strictly as an observer only and with no right to be heard). The preliminary hearing should take place as soon as possible by telephone conference call unless the Chairman determines otherwise. The non-participation, without compelling justification, of the *Participant* or his/her representative at the preliminary hearing, after proper notice of the preliminary hearing has been provided, shall not prevent the Chairman of the *Anti-Corruption Tribunal* from proceeding with the preliminary hearing, whether or not any written submissions are made on behalf of the *Participant*.
- 5.1.4 The purpose of the preliminary hearing shall be to allow the Chairman to address any issues that need to be resolved prior to the hearing date. In particular (but without limitation), the Chairman shall:
- 5.1.4.1 determine the date(s) upon which the full hearing shall be held. Save in exceptional circumstances or where the parties otherwise agree, the full hearing should take place no longer than forty (40) days after the receipt by the *Participant* of the *Notice of Charge*;
- 5.1.4.2 establish dates reasonably in advance of the date of the full hearing by which:
- a) the *ICC* shall submit an opening brief with argument on all issues that the *ICC* wishes to raise at the hearing and a list of the witnesses that the *ICC* intends to call at the hearing (and a summary of the subject areas of the witness's anticipated testimony), and enclosing copies of the exhibits that the *ICC* intends to introduce at the hearing;

- b) the *Participant* shall submit an answering brief, addressing the *ICC*'s arguments and setting out argument on the issues that he/she wishes to raise at the hearing, as well as a list of the witnesses that he/she intends to call at the hearing (and a summary of the subject areas of the witness's anticipated testimony), and enclosing copies of the exhibits that he/she intends to introduce at the hearing; and
 - c) the *ICC* may (at its discretion) submit a reply brief, responding to the answer brief of the *Participant* and listing any rebuttal witnesses that the *ICC* intends to call at the hearing (and a summary of the subject areas of the witness's anticipated testimony), and enclosing copies of any other exhibits that the *ICC* intends to introduce at the hearing; and
- 5.1.4.3 make such order as the Chairman shall deem appropriate (subject to any principles of applicable national law) in relation to the production of relevant documents and/or other materials between the parties .
- 5.1.5 The *Participant* shall be required to raise at the preliminary hearing any legitimate objection that he/she may have to any of the members of the *Anti-Corruption Tribunal* convened to hear his/her case. Any unjustified delay in raising any such objection shall constitute a waiver of the objection. If any objection is made, the Chairman of the *Anti-Corruption Tribunal* shall rule on its legitimacy (or, if the objection relates to the Chairman, the Chairman of the *ICC Code of Conduct Commission* shall rule on its legitimacy).
- 5.1.6 If, because of a legitimate objection or for any other reason, a member of the *Anti-Corruption Tribunal* is, or becomes, unwilling or unable to hear the case, then the Chairman of the *ICC Code of Conduct Commission* may, at his/her absolute discretion: (a) appoint a replacement member of the *Anti-Corruption Tribunal* from the *ICC's Code of Conduct Commission*; or (b) authorise the remaining members to hear the case on their own.
- 5.1.7 Subject to the discretion of the Chairman of the *Anti-Corruption Tribunal* to order otherwise for good cause shown by either party (for example, and notwithstanding clause 5.1.8, where, having due regard to the seriousness of the alleged offence, the costs of attending any hearing are disproportionate to the *Participant's* means and therefore prohibit him/her from having a fair opportunity to present his/her case), or unless otherwise agreed between the parties, hearings before the *Anti-Corruption Tribunal* shall: (a) take place at the *ICC's* headquarters in Dubai, United Arab Emirates; and (b) be conducted on a confidential basis.
- 5.1.8 Each of the *ICC* and the *Participant* has the right to be present and to be heard at the hearing and (at his/her or its own expense) to be represented at the hearing by legal counsel of his/her or its own choosing. At the discretion of the *Anti-Corruption Tribunal*, a representative of the *Participants* relevant *National Cricket Federation* may also attend any such hearing (but strictly as an observer only and with no right to be heard). Where there is compelling justification for the non-attendance by any party or representative at the hearing, then such party or representative shall be given the opportunity to participate in the hearing by telephone or video conference (if available).

- 5.1.9 Without prejudice to Article 3.2.2, the *Participant* may choose not to appear in person at the hearing, but instead provide a written submission for consideration by the *Anti-Corruption Tribunal*, in which case the *Anti-Corruption Tribunal* shall consider the submission in its deliberations. However, the non-attendance of the *Participant* or his/her representative at the hearing, after proper notice of the hearing has been provided, without compelling justification, shall not prevent the *Anti-Corruption Tribunal* from proceeding with the hearing in his/her absence, whether or not any written submissions are made on his/her behalf.
- 5.1.10 The procedure followed at the hearing shall be at the discretion of the Chairman of the *Anti-Corruption Tribunal*, provided that the hearing is conducted in a manner which offers the *Participant* a fair and reasonable opportunity to present evidence (including the right to call and to question witnesses by telephone or video-conference where necessary), address the *Anti-Corruption Tribunal* and present his/her case.
- 5.1.11 For the avoidance of any doubt, where two or more *Participants* are alleged to have committed offences under the *Anti-Corruption Code*, they may both be dealt with at the same hearing where the proceedings arise out of the same incident or set of facts, or where there is a clear link between separate incidents.
- 5.1.12 Save where the Chairman orders otherwise for good cause shown by either party, the hearing shall be in English, and certified English translations shall be submitted of any non-English documents put before the *Anti-Corruption Tribunal*. The cost of the translation shall be borne by the party offering the document(s). If required by the Chairman, the ICC shall make arrangements to have the hearing recorded or transcribed (save for the private deliberations of the *Anti-Corruption Tribunal*). If requested by the *Participant*, the ICC shall also arrange for an interpreter to attend the hearing. The costs of transcription and interpretation shall be paid by the ICC, subject to any costs-shifting order that the *Anti-Corruption Tribunal* may make further to Article 5.2.3.

5.2 Decisions of the *Anti-Corruption Tribunal*

- 5.2.1 The *Anti-Corruption Tribunal* shall announce its decision in writing, with reasons, as soon as possible after the conclusion of the hearing. That written decision will set out and explain:
- 5.2.1.1 with reasons, the *Anti-Corruption Tribunal's* findings as to whether any offence(s) under the *Anti-Corruption Code* has/have been committed;
- 5.2.1.2 with reasons, the *Anti-Corruption Tribunal's* findings as to what sanctions, if any, are to be imposed (including any fine and/or period of *Ineligibility*);
- 5.2.1.3 with reasons, the date that such period of *Ineligibility* shall commence pursuant to Article 6.4; and
- 5.2.1.4 the rights of appeal described in Article 7.

Any such written decision (with reasons) will be provided to the *Participant*, with a copy to his/her relevant *National Cricket Federation*.

- 5.2.2 The *Anti-Corruption Tribunal* shall have discretion to announce the substance of its decision to the parties prior to the issue of the written reasoned decision referred to in Article 5.2.1 in cases where a *Provisional Suspension* has been imposed or where it otherwise deems appropriate. For the avoidance of doubt, however: (a) the *Anti-Corruption Tribunal* shall still be required to issue a written, reasoned decision in accordance with Article 5.2.1; and (b) the time to appeal pursuant to Article 7 shall not run until receipt of that written, reasoned decision.
- 5.2.3 The *Anti-Corruption Tribunal* has the power to make a costs order against any party to the hearing in respect of the costs of convening the *Anti-Corruption Tribunal* and of staging the hearing and/or in respect of the costs (legal, expert, travel, accommodation or otherwise) incurred by the parties in relation to the proceedings if it considers that such party has acted spuriously, frivolously or otherwise in bad faith. If it does not exercise that power, the *ICC* shall pay the costs of convening the *Anti-Corruption Tribunal* and of staging the hearing, and each party shall bear its own costs (legal, expert, travel, accommodation or otherwise).
- 5.2.4 Subject only to the rights of appeal under Article 7, the *Anti-Corruption Tribunal's* decision shall be the full, final and complete disposition of the matter and will be binding on all parties.

ARTICLE 6 - SANCTIONS

- 6.1 Where it is determined that an offence under the *Anti-Corruption Code* has been committed, the *Anti-Corruption Tribunal* will be required to impose an appropriate sanction upon the *Participant* from the range of permissible sanctions described in Article 6.2. In order to determine the appropriate sanction that is to be imposed in each case, the *Anti-Corruption Tribunal* must first determine the relative seriousness of the offence, including identifying all relevant factors that it deems to:
- 6.1.1 aggravate the nature of the offence under the *Anti-Corruption Code*, including (without limitation):
- 6.1.1.1 a lack of remorse on the part of the *Participant*;
 - 6.1.1.2 whether the *Participant* has previously been found guilty of any similar offence under the *Anti-Corruption Code* or any predecessor regulations, whether by the *ICC*, or by any *National Cricket Federation*;
 - 6.1.1.3 where the amount of any profits, winnings or other *Reward*, directly or indirectly received by the *Participant* as a result of the offence(s), is substantial and/or where the sums of money otherwise involved in the offence(s) were substantial;
 - 6.1.1.4 where the offence substantially damaged (or had the potential to damage substantially) the commercial value and/or the public interest in the relevant *International Match(es)* or *ICC Event(s)*;
 - 6.1.1.5 where the offence affected (or had the potential to affect) the result of the relevant *International Match(es)* or *ICC Event(s)*;
 - 6.1.1.6 where the welfare of a *Participant* has been endangered as a result of the offence;
 - 6.1.1.7 where the offence involved more than one *Participant*; and/or
 - 6.1.1.8 any other aggravating factor(s) that the *Anti-Corruption Tribunal* considers relevant and appropriate.

- 6.1.2 mitigate the nature of the offence under the *Anti-Corruption Code*, including (without limitation):
- 6.1.2.1 any admission of guilt (the mitigating value of which may depend upon its timing);
 - 6.1.2.2 the *Participant's* good previous disciplinary record;
 - 6.1.2.3 the young age and/or lack of experience of the *Participant*;
 - 6.1.2.4 where the *Participant* has cooperated with the ACSU and any investigation or *Demand* carried out by it;
 - 6.1.2.5 where the offence did not substantially damage (or have the potential to substantially damage) the commercial value and/or the public interest in the relevant *International Match(es)* or *ICC Event(s)*;
 - 6.1.2.6 where the offence did not affect (or have the potential to affect) the result of the relevant *International Match(es)* or *ICC Event(s)*;
 - 6.1.2.7 where the *Participant* provides *Substantial Assistance* to the *ICC*, a criminal authority or professional disciplinary body that results in the *ICC* discovering or establishing an offence under the *Anti-Corruption Code* by another *Participant* or that results in a criminal or disciplinary body discovering or establishing a criminal offence or the breach of professional rules by another *Participant* or other third party;
 - 6.1.2.8 where the *Participant* has already suffered penalties under other laws and/or regulations for the same offence; and/or
 - 6.1.2.9 any other mitigating factor(s) that the *Anti-Corruption Tribunal* considers relevant and appropriate.

6.2 Having considered all of the factors described in Articles 6.1.1 and 6.1.2, the *Anti-Corruption Tribunal* shall then determine, in accordance with the following table, what the appropriate sanction(s) should be:

ANTI CORRUPTION CODE OFFENCE	RANGE OF PERMISSIBLE PERIOD OF INELIGIBILITY	ADDITIONAL DISCRETION TO IMPOSE A FINE
Articles 2.1.1, 2.1.2, 2.1.3 and 2.1.4 (Corruption)	A minimum of five (5) years and a maximum of a lifetime.	AND (in all cases) the <i>Anti-Corruption Tribunal</i> shall have the discretion to impose a fine on the <i>Participant</i> up to a maximum of the value of any <i>Reward</i> received by the <i>Participant</i> directly or indirectly, out of, or in relation to, the offence committed under the <i>Anti-Corruption Code</i> .
Articles 2.2.1, 2.2.2 and 2.2.3 (Betting)	A minimum of two (2) years and a maximum of five (5) years.	
Articles 2.3.1 and 2.3.3 (as it relates to an offence under Article 2.3.2) (Misuse of inside information)	A minimum of two (2) years and a maximum of five (5) years.	
Articles 2.3.2 and 2.3.3 (as it relates to an offence under Article 2.3.2) (Misuse of inside information)	A minimum of six (6) months and a maximum of five (5) years.	
Articles 2.4.1 and 2.4.2 (General)	A minimum of one (1) year and a maximum of five (5) years.	
Articles 2.4.3 and 2.4.4 (General)	A minimum of six (6) months and a maximum of two (2) years.	

- 6.3 For the avoidance of doubt:
- 6.3.1 the *Anti-Corruption Tribunal* will have no jurisdiction to adjust, reverse or amend the results of any *International Match* or *ICC Event*;
 - 6.3.2 where a *Participant* is found guilty of committing two *Anti-Corruption Code* offences in relation to the same incident or set of facts and sanctioned separately, then any sanctions imposed should run concurrently (and not cumulatively);
 - 6.3.3 where a fine and/or costs award is imposed against a *Participant*, then such fine and/or costs award must be paid: (a) by the *Participant* (and not, unless the *ICC* agrees, by any other third party, including a *National Cricket Federation*); (b) directly to the *ICC* within one calendar month of receipt of the decision imposing the fine. However, the *ICC* will consider any request from any *Participant*, on the grounds of financial hardship, to make the payment of such fines and/or costs over a prolonged period of time. Should any fine and/or costs award (or agreed part-payment or instalment thereof) not be paid to the *ICC* within such deadline or by the time of the next agreed payment date, then, unless the *ICC* agrees otherwise, the *Participant* may not play, coach or otherwise participate or be involved in any capacity in any *International Match* until such payment has been satisfied in full; and
 - 6.3.4 the *ICC* will provide the *National Cricket Federation* of the *Participant* with written notice of (and a full written copy of) the findings and decisions of the *Anti-Corruption Tribunal* (including any sanctions imposed by the *Anti-Corruption Tribunal*) at the same time as such decision is provided to the *Participant* and prior to publicly announcing such decisions.
- 6.4 Any period of *Ineligibility* imposed on a *Participant* shall commence on the date that the decision imposing the period of *Ineligibility* is issued; provided that any period of *Provisional Suspension* served by the *Participant* shall be credited against the total period of *Ineligibility* to be served.
- 6.5 No *Participant* who has been declared *Ineligible* may, during the period of *Ineligibility*, play, coach officiate or otherwise participate or be involved in any capacity in any *International Match* or any other kind of *Match*, function, event or activity (other than authorised anti-corruption education or rehabilitation programs) that is authorised, organised, sanctioned, recognised or supported in any way by the *ICC*, a *National Cricket Federation* or any member of a *National Cricket Federation*. *National Cricket Federations* shall take all reasonable steps within their powers to give effect to this Article 6.5 where they have the jurisdiction to do so.
- 6.6 A *Participant* who is subject to a period of *Ineligibility* shall remain subject to the *Anti-Corruption Code* during that period. If a *Participant* commits an offence under the *Anti-Corruption Code* during a period of *Ineligibility*, this shall be treated as a separate offence under the *Anti-Corruption Code* and separate proceedings will be brought pursuant to Article 4.5.
- 6.7 Once any period of *Ineligibility* has expired, the *Participant* will automatically become re-eligible to participate (in the case of a *Player*) or assist a *Player's* participation (in the case of a *Player Support Personnel*) or officiate (in the case of an *Umpire* or *Match Referee*) or be appointed to support an *Umpire* or *Match Referee* (in the case of an *Umpire Support Personnel*) in *International Matches* and/or *Matches* provided that he/she has first: (a) completed an official anti-corruption education session to the reasonable satisfaction of *ACSU*; (b) satisfied, in full, any fine and/or award of costs made against him/her by any *Anti-Corruption Tribunal* or *CAS* panel; and (c) agreed to subject him/herself to such additional reasonable and proportionate monitoring procedures and requirements as the *ACSU's General Manager* may reasonably consider necessary given the nature and scope of the offence committed.

ARTICLE 7 - APPEALS

- 7.1** The following decisions made under the *Anti-Corruption Code* may be challenged by the *ICC* or the *Participant* who is the subject of the decision (as applicable) solely by appeal to *CAS* as set out in this Article 7:
- 7.1.1 a decision to impose a *Provisional Suspension*;
 - 7.1.2 a decision that a charge of breach of the *Anti-Corruption Code* should be dismissed for procedural or jurisdictional reasons;
 - 7.1.3 a decision that an offence under the *Anti-Corruption Code* has (or has not) been committed; and/or
 - 7.1.4 a decision to impose (or not to impose) sanctions, including the appropriateness of any sanction imposed for an offence under the *Anti-Corruption Code*.
- 7.2** Decisions being appealed shall remain in effect and binding pending resolution of the appeal.
- 7.3** The deadline for filing an appeal to *CAS* shall be twenty-one (21) days from the date of receipt of the written reasoned decision by the appealing party. To be a valid filing under this Article, a copy of the appeal must also be filed on the same day with the *ICC*, a copy of which will thereafter be filed with the *Participant's* relevant *National Cricket Federation*. In all appeals to *CAS* pursuant to this Article 7:
- 7.3.1 *CAS's* Code of Sports-related Arbitration shall apply, save as amended below.
 - 7.3.2 Where required in order to do justice (for example to cure procedural errors at the first instance hearing), the appeal shall take the form of a re-hearing *de novo* of the issues raised by the case. In all other cases, the appeal shall not take the form of a *de novo* hearing but instead shall be limited to a consideration of whether the decision being appealed was erroneous.
 - 7.3.3 The governing law shall be English law and the appeal shall be conducted in English, unless the parties agree otherwise.
 - 7.3.4 The decision of *CAS* on the appeal shall be final and binding on all parties, and no right of appeal shall lie from the *CAS* decision.

ARTICLE 8 - PUBLIC DISCLOSURE AND CONFIDENTIALITY

- 8.1** Neither the *ICC* nor any *National Cricket Federation* shall publicly identify any *Participant* who has been alleged to have committed an offence under the *Anti-Corruption Code* until it has been determined in a hearing in accordance with Article 5 that an offence has been committed, or such hearing has been waived, or the assertion of an offence has not been timely challenged. Once it is decided that an offence under the *Anti-Corruption Code* has been established, publication of that decision shall be determined in accordance with the following principles:
- 8.1.1 If the decision of the *Anti-Corruption Tribunal* is that an offence has been committed: (a) the decision may, at the *ICC's* discretion, be publicly reported in full as soon as possible; and (b) after the decision is publicly reported, the *ICC* may also publish such other parts of the proceedings before the *Anti-Corruption Tribunal* as the *ICC* thinks fit.

8.1.2 If the *Anti-Corruption Tribunal* exonerates the *Participant*, then the decision may be publicly reported only with the consent of the *Participant* who is the subject of the decision. The *ICC* shall use reasonable efforts to obtain such consent, and if consent is obtained, shall publicly disclose the decision in its entirety or in such redacted form as the *Participant* may approve.

- 8.2 The *ICC* shall use its best endeavours to ensure that persons under its control do not publicly identify *Participants* who are alleged to have committed an offence under the *Anti-Corruption Code*, unless and until an *Anti-Corruption Tribunal* has determined that an offence has been committed, and/or the offence has been admitted. However, the *ICC* in its discretion may at any time disclose to other organisations such information as the *ICC* may consider necessary or appropriate to facilitate administration or enforcement of the *Anti-Corruption Code*, provided that each organisation provides assurance satisfactory to the *ICC* that the organisation will maintain all such information in confidence. The *ICC* will not comment publicly on the specific facts of a pending case except in response to public comments made by (or on behalf of) the *Participant* involved in the case or his/her representatives.

ARTICLE 9 - RECOGNITION OF DECISIONS

- 9.1 It shall be a condition of membership of the *ICC* that all *National Cricket Federations* shall comply with, recognise and take all necessary and reasonable steps within their powers to enforce and give effect to the *Anti-Corruption Code* and to all decisions taken and sanctions imposed thereunder. This shall include (without limitation), where it has the jurisdiction to do so, requiring the organisers of any *Matches*, tournaments or other events sanctioned by the *National Cricket Federation* to recognise and give effect to such decisions and sanctions.
- 9.2 Decisions and sanctions of *National Cricket Federations* that are within the *National Cricket Federation's* jurisdiction and based on same or similar anti-corruption rules shall be recognised and respected by the *ICC* and all other *National Cricket Federations* (including in respect of any *Matches*, tournaments or other events sanctioned by such *National Cricket Federation*), automatically upon receipt of notice of the same, without the need for further formality.

ARTICLE 10 - STATUTE OF LIMITATIONS

- 10.1 No action may be commenced under the *Anti-Corruption Code* against a *Participant* for an offence under the *Anti-Corruption Code* more than eight years after the date that the offence occurred.
- 10.2 Subject strictly to Article 10.1, the *ICC* may temporarily suspend investigations under the *Anti-Corruption Code* to avoid prejudice to, and/or to give precedence to, investigations conducted by other relevant authorities into the same or related matters.

ARTICLE 11 - AMENDMENT AND INTERPRETATION OF THE ANTI-CORRUPTION CODE

- 11.1 The *Anti-Corruption Code* may be amended from time to time by the *ICC's* Executive Board, with such amendments coming into effect on the date specified by the *ICC*.
- 11.2 The headings used for the various Articles of the *Anti-Corruption Code* are for the purpose of guidance only and shall not be deemed to be part of the substance of the *Anti-Corruption Code* or to inform or affect in any way the language of the provisions to which they refer.

- 11.3 The *Anti-Corruption Code* shall come into full force and effect on 10 October 2012 (the '**Effective Date**'). It shall not operate to disturb any decisions and/or sanctions previously made under predecessor versions of the *Anti-Corruption Code* (including the *Code of Conduct*) or anti-corruption rules of *National Cricket Federations*, nor shall it apply retrospectively to matters pending before the *Effective Date*; provided, however, that any case pending prior to the *Effective Date*, or brought after the *Effective Date* but based on acts or omissions that occurred before the *Effective Date*, shall be governed by the predecessor version of the *Anti-Corruption Code* in force at the time of the alleged offence, subject to any application of the principle of *lex mitior* by the hearing panel determining the case.
- 11.4 If any Article or provision of this *Anti-Corruption Code* is held invalid, unenforceable or illegal for any reason, it shall be deemed deleted, and the *Anti-Corruption Code* shall remain otherwise in full force and effect.
- 11.5 The *Anti-Corruption Code* is governed by and shall be construed in accordance with English law. Strictly without prejudice to the arbitration provisions of Articles 5 and 7 of the *Anti-Corruption Code*, disputes relating to the *Anti-Corruption Code* shall be subject to the exclusive jurisdiction of the English courts.

APPENDIX 1 - DEFINITIONS

Anti-Corruption Code. This *Anti-Corruption Code* promulgated by the ICC on the *Effective Date*.

ACSU. See *Anti-Corruption and Security Unit*.

Anti-Corruption and Security Unit. The department within the ICC mandated, amongst other things, to monitor compliance with and investigate potential breaches of the *Anti-Corruption Code*.

ACSU General Manager. An appointee of the ICC with supervisory responsibilities in relation to the *Anti-Corruption Code*.

Anti-Corruption Tribunal. A panel of three persons (subject to Article 5.1.6) appointed by the *Chairman* of the *ICC Code of Conduct Commission*, to perform the functions assigned to the *Anti-Corruption Tribunal* under the *Anti-Corruption Code*. Each member of the *Anti-Corruption Tribunal* shall be a member of the *ICC Code of Conduct Commission* and the ICC may provide reasonable compensation and reimbursement of expenses to such members.

Bet. Any wager, bet or other form of financial speculation.

Betting Organisation. Any company or other undertaking that promotes, brokers, arranges or conducts any form of *Betting* activity in relation to *International Matches* or *ICC Events*.

CAS. The Court of Arbitration for Sport in Lausanne, Switzerland.

Code of Conduct. The ICC's *Code of Conduct for Players and Player Support Personnel*, as amended from time to time.

Demand. As defined in Article 4.3.

Effective Date. As defined in Article 11.3.

ICC. The International Cricket Council or its designee.

ICC's Chief Executive Officer. The person appointed by the ICC from time to time to act as the ICC's Chief Executive Officer (or his/her designee).

ICC's Clothing and Equipment Rules and Regulations. The ICC's Clothing and Equipment Regulations (a copy of which is set out in the *ICC's Operating Manual*), as amended from time to time.

ICC Code of Conduct Commission. An official committee of the ICC established, amongst other things, to provide independent enquiries, investigations and rulings in relation to matters brought to its attention pursuant to the *Code of Conduct*. Each member of the *ICC Code of Conduct Commission* shall be independent of the ICC, which may provide reasonable compensation and reimbursement of expenses to such members.

ICC Code of Conduct for Umpires and Referees. The ICC's Code of Conduct for Umpires and Referees, in force from time to time.

ICC Events. Each of the following: (a) the ICC Cricket World Cup; (b) the ICC World Twenty20; (c) the ICC Champions Trophy; (d) the ICC World Cricket League Divisions 1-8 (inclusive), together with any regional qualifying events thereto; (e) the ICC Women's Cricket World Cup; (f) the ICC Under 19 Cricket World Cup; (g) the ICC World Cup Qualifying Tournament; (h) the ICC Women's Cricket World Cup Qualifying Tournament, together with any regional qualifying events thereto; (i) the ICC World Twenty20 Qualifying Tournament; (j) the ICC Under 19 Cricket World Cup Qualifying Tournament, together with any regional qualifying events thereto; (k) the ICC Intercontinental Cup and Shield; and (l) any other event organised or sanctioned by the ICC from time to time to which the ICC deems it appropriate that the *Anti-Corruption Code* should apply.

ICC's Head of Legal. The person appointed by the ICC from time to time to act as the ICC's Head of Legal (or his/her designee).

ICC's Minimum Standards for Players and Match Officials Area. The ICC's Minimum Standards for Players and Match Officials Area (a copy of which is set out in the ICC's *Operating Manual*), as amended from time to time.

ICC's Policy on Member Associations with Betting Companies. The ICC's Policy on Member Associations with Betting Companies (a copy of which is set out in the ICC's *Operating Manual*), as amended from time to time.

ICC's Operating Manual. The ICC's Official Operating Manual in force from time to time.

Ineligibility. Means the *Participant* is barred for a specified period of time from participation in the sport of cricket, as set out more specifically in Article 6.5.

Inside Information. Any information relating to any *International Match* or *ICC Event* that a *Participant* possesses by virtue of his/her position within the sport. Such information includes, but is not limited to, factual information regarding the competitors in the *International Match* or *ICC Event*, the conditions, tactical considerations or any other aspect of the *International Match* or *ICC Event*, but does not include such information that is already published or a matter of public record, readily acquired by an interested member of the public, or disclosed according to the rules and regulations governing the relevant *International Match* or *ICC Event*.

International Match. Each of the following (in men's and women's cricket): (a) any *Test Match*, *One Day International Match* or *Twenty20 International Match*; (b) any *Match* played as part of an *ICC Event*; (c) any *International Tour Match*; or (d) any other *Match* organised or sanctioned by the ICC from time to time to which the ICC deems it appropriate that the *Anti-Corruption Code* should apply.

International Tour Match. Any *Match* played between a representative team of a *Full Member* (or *Associate Member* with Test and/or ODI or T20I Status) and any domestic, guest or invitational team.

Match. A cricket match of any format and duration in length in which two cricket teams compete against each other.

Match Referee. The independent person appointed by the ICC (or any other relevant party) as the official match referee for a designated *International Match*, whether such *Match Referee* carries out his/her functions remotely or otherwise.

National Cricket Federation. A national or regional entity which is a member of or is recognised by the ICC as the entity governing the sport of cricket in a country (or collective group of countries associated for cricket purposes).

Notice of Charge. As defined in Article 4.5.

One Day International Match. As defined by Section 33 (ICC Classification of Official Cricket) of the ICC's *Operating Manual*.

Participant. Any *Player*, *Player Support Personnel*, *Umpire*, *Match Referee* or *Umpire Support Personnel*.

Player. Any cricketer who is selected (or who has been selected in the preceding twelve (12) months) in any playing or touring team or squad that is chosen to represent a *National Cricket Federation* in any *International Match* or series of *International Matches*.

Player Support Personnel. Any coach, trainer, manager, selector, team official, doctor, physiotherapist or any other person employed by, representing or otherwise affiliated to a playing/touring team or squad that is chosen to represent a *National Cricket Federation* in any *International Match* or series of *International Matches*.

Provisional Hearing. For purposes of Article 4.6, an expedited abbreviated hearing before the Chairman of the *ICC Code of Conduct Commission* (sitting alone) occurring prior to a hearing under Article 5 that provides the *Participant* with notice and an opportunity to be heard in either written or oral form.

Provisional Suspension. Means the *Participant* is temporarily barred from participating in the sport of cricket pending a decision on the allegation that he/she has committed an offence under the *Anti-Corruption Code*, as set out more specifically in Article 4.6.

Reward. A person acts 'for *Reward*' if he/she arranges or agrees that he/she or some other third party will receive any direct or indirect financial or other benefit for that act (other than official prize money and/or contracted payments under playing, service, endorsement, sponsorship or other such similar contracts), and the term '*Reward*' shall be construed accordingly.

Substantial Assistance. For purposes of Article 6.2.2.7, a *Participant* must: (a) fully disclose in a signed witness statement all information that he/she possesses in relation to offences under the *Anti-Corruption Code*; and (b) reasonably cooperate with the investigation and adjudication of any case related to that information, including, for example, presenting testimony at a hearing if requested to do so by the *ICC*. Further, the information provided must be credible and must comprise an important part of any case that is initiated or, if no case is initiated, must have provided a sufficient basis on which a case could have been brought.

Test Match. As defined by Section 33 (ICC Classification of Official Cricket) of the *ICC's Operating Manual*.

Twenty20 International Match. As defined by Section 33 (ICC Classification of Official Cricket) of the *ICC's Operating Manual*.

Umpire. Any umpire (including any on-field umpire, television umpire, third or fourth umpire) appointed (by the *ICC* or any other relevant party) to officiate in any *International Match*.

Umpire Support Personnel. Any technical officials (for example, and without limitation, any official with responsibility for operating the communication equipment for *Umpires* and *Match Referees* during an *International Match*) or umpire coaches appointed (by the *ICC* or any other relevant party) to support the *Umpires* and/or *Match Referees* in their appointments to any *International Match*.

ICC REGULATIONS FOR THE REVIEW OF
BOWLERS REPORTED WITH **SUSPECTED**
ILLEGAL BOWLING ACTIONS

ICC REGULATIONS FOR THE REVIEW OF BOWLERS REPORTED WITH SUSPECTED ILLEGAL BOWLING ACTIONS

TERMS OF REFERENCE

(As amended by CEC at its meeting in July 2013)

DEFINITIONS

In these Regulations the following words and phrases have the following meanings:

Home Board means the national board or association which the Player plays for when representing his country at cricket.

Host Country means the country in which the relevant Match takes place.

Illegal Bowling Action means a bowling action which contravenes Law 24.2 (as read with Law 24.3) of the Laws of Cricket.

Match means a match defined as International Cricket in accordance with paragraph 1.1.1 below.

Match Referee means the referee appointed for the relevant Match.

Player(s) means a cricketer who participates or has participated in International Cricket.

Umpire means the umpire appointed for the relevant Match.

1 INTRODUCTION

1.1 These Regulations:

- 1.1.1 Detail the process for dealing with Players suspected of bowling in a manner which constitutes an Illegal Bowling Action in any of the following Matches (collectively defined as International Cricket):
 - a) Tests, One Day and Twenty20 Internationals (Men's and Women's); and
 - b) Matches other than those set out above which form part of the following ICC events:

ICC U19 CWC, ICC World Cricket League 1-8 inclusive, ICC CWC Qualifier, ICC World T20 Qualifier, ICC U19 CWC Global Qualifier, ICC Intercontinental Cup and Shield and any other event organised or sanctioned by the ICC from time to time to which the ICC deems it appropriate that these Regulations should apply.
- 1.1.2 Provide for an additional mechanism for the reporting of Players suspected of bowling in a manner which constitutes an Illegal Bowling Action at the ICC U19 CWC and the ICC CWC Qualifier.
- 1.1.3 Provide for certain minimum requirements to be followed by ICC Members relating to Players suspected of bowling in a manner which constitutes an Illegal Bowling Action in their domestic matches.

- 1.2 Nothing contained herein shall override an Umpire's responsibility and discretion to apply Law 24 of the Laws of Cricket.

2 TESTS, ONE-DAY AND TWENTY20 INTERNATIONALS

If in a Match as set out in paragraph 1.1.1(a) above, a Player is called by an Umpire under the provisions of Law 24.2 or is suspected by an Umpire or the Match Referee of bowling with an Illegal Bowling Action, the following procedure shall apply.

Note: Umpires and Match Referees, in deciding whether to cite a Player under these Regulations, should use the naked eye viewing the action live and/or on television at normal speed. Slow motion television replays should only be used to confirm initial suspicions.

2.1 Reporting Procedure

- 2.1.1 At the conclusion of the relevant Match, the Umpire(s) and/or Match Referee shall write a report (the Match Officials' Report) detailing their concerns about the bowling action of the relevant Player including, where relevant, whether those concerns relate to the Player's bowling action generally or whether they relate to one or more specific types of delivery.
- 2.1.2 If the Match Officials' Report is written by the Umpires it shall be passed to the Match Referee.
- 2.1.3 Within 24 hours of the conclusion of the Match in which the Player is reported, the Match Referee shall furnish the Player's team manager and the ICC with a copy of the Match Officials' Report.
- 2.1.4 Once the Player's team manager and the ICC have been furnished with a copy of the Match Officials' Report and within 24 hours thereof, the Match Referee, through the Board of the Host Country, shall make a media statement to the effect that the Player has been reported as having a suspected Illegal Bowling Action and that he will be subject to the ICC review process as set out herein.
- 2.1.5 If the Match is a televised Match, upon receipt of the Match Officials' Report from the Match Referee, the ICC shall arrange for three copies of the television footage of the bowling spells of the Player in the relevant Match to be produced as soon as possible. Once these tapes have been received, the ICC shall immediately write to the Player's Home Board confirming that the Player has been reported for a suspected Illegal Bowling Action and enclosing the Match Officials' Report and two copies of the tape referred to above. The Board shall retain one copy for its own purposes and the other shall be forwarded to the Player. The third copy shall be retained by the ICC for the independent analysis and any BRG hearing referred to in paragraphs 2.2 and 2.3 below. If no television footage is available, upon receipt of the Match Officials' Report from the Match Referee, the ICC shall immediately write to the Player's Home Board confirming that the Player had been reported for a suspected Illegal Bowling Action and enclosing the relevant Match Officials' Report.

2.2 ICC independent analysis

- 2.2.1 If a Player is reported in accordance with paragraph 2.1.1 above, he shall be required to submit to an independent analysis of his bowling action (Independent Analysis) carried out as follows:
- 2.2.2 The ICC shall appoint on an annual basis a panel of human movement specialists.

- 2.2.3 The members of this panel shall have the credentials, equipment and facilities to conduct analysis of the bowling actions of Players in accordance with the ICC Standard Analysis Protocols (Annexure 1 hereto).
- 2.2.4 The Independent Analysis shall be carried out by a member of the ICC panel of human movement specialists referred to in paragraph 2.2.2 above (the Appointed Specialist), appointed by the ICC in consultation with the Player's Home Board. The Appointed Specialist shall not be domiciled in the country which the Player represents in International Cricket.
- 2.2.5 The Independent Analysis shall be carried out as soon as reasonably possible but, in any event, within 21 days of receipt by the Player's Home Board of the notice referred to in paragraph 2.1.5 above. See paragraph 2.2.15 below for Players reported during ICC events.
- 2.2.6 The Independent Analysis shall be carried out in accordance with the ICC Standard Analysis Protocols and shall take into account the Match Officials' Report. If the Player expresses any concern or complaint regarding the circumstances or conduct of the Independent Analysis, he should make these known to the Appointed Specialist before the conclusion of the Independent Analysis. The Appointed Specialist should make a written note of the relevant concern or complaint which should be agreed with the Player.
- 2.2.7 The ICC shall be responsible for determining the time and place at which the Independent Analysis shall be carried out and shall ensure that the Player, through the Player's Home Board, is given reasonable notice thereof. All travel and accommodation arrangements shall be made by the ICC in consultation with the Player's Home Board.
- 2.2.8 In the event of the Player failing to submit to the Independent Analysis as required above, such failure will be regarded as an admission that he bowls with an Illegal Bowling Action and he shall be immediately suspended from bowling in International Cricket until such time as he so submits and satisfactorily participates in an Independent Analysis.
- 2.2.9 Within 14 days of the date for the carrying out of the Independent Analysis, the Appointed Specialist shall furnish the ICC with a written report (hereinafter referred to as the Independent Assessment) in the form as set out in the ICC Standard Analysis Protocols. Where the Independent Assessment concludes that the Player employed an Illegal Bowling Action during the Independent Analysis, it should indicate whether the Player employed an Illegal Bowling Action generally or in respect of specific type(s) of delivery only and whether, in the Appointed Specialists opinion, such conclusion is not inconsistent with the relevant video evidence. Where the Independent Assessment concludes that the Player did not employ an Illegal Bowling Action during the Independent Analysis, it should, where relevant, indicate whether, in the opinion of the Appointed Specialist, the Player's bowling action during the Independent Analysis was materially different to his action in the Match in respect of which he was cited (whether generally or in respect of the specific type(s) of delivery (if any) identified in the Match Officials' Report). The Independent Assessment should also include any notes of concerns or complaints of the Player made under paragraph 2.2.6 above. See paragraph 2.2.15 below for Players reported during ICC events.

- 2.2.10 Immediately upon receipt of the Independent Assessment by the ICC, the ICC shall furnish the Players Home Board with a copy thereof.
- 2.2.11 Subject to paragraph 2.2.12 below, in the event that the Independent Assessment concludes either that (i) the Player employed an Illegal Bowling Action during the Independent Analysis and that such conclusion is not inconsistent with the relevant video footage or that (ii) the Player's bowling action during the Independent Analysis was materially different to his action in the Match in respect of which he was reported, the Player shall immediately be suspended from bowling in International Cricket until such time as he has submitted to a fresh Independent Analysis in accordance with the provisions set out in paragraph 2.4 below, and in which fresh Independent Analysis it is concluded that he has remedied his action. The suspension shall become operative from the date of receipt by the Player's Home Board of a copy of the Independent Assessment in accordance with paragraph 2.2.10 above.

Note: The ICC Standard Analysis Protocols contains reference to a level of acceptable elbow extension. Should the Independent Assessment conclude that the Player's bowling action exhibits a degree of elbow extension of the bowling arm higher than the said acceptable level, the action of the Player shall be deemed to be an Illegal Bowling Action. It should be noted that in order for the Player's bowling action to be classified as a legal action, the degree of elbow extension recorded for each and every delivery must be within the level of acceptable elbow extension.

- 2.2.12 In circumstances where the Independent Assessment concludes that the Player employed an Illegal Bowling Action during the Independent Analysis in respect of a specific type of delivery only, the Player will be allowed to continue bowling in International Cricket but subject to the warning (Warning) that should he continue to bowl any of the specific type(s) of delivery for which he has been found to have an Illegal Bowling Action, he will run the risk of being cited a second time.

In these circumstances a further report resulting in an Independent Analysis concluding that the Player has employed an Illegal Bowling Action will result in the immediate suspension of the Player from bowling in International Cricket and such suspension shall be considered a second suspension under the provisions of paragraph 2.5 below.

Note: This is intended to cover the circumstances where a Player employs a different technique to deliver a specific type of delivery e.g. propelling the ball out of the back of the hand to produce a "googly" or "doosra". It is not intended to cover the situation where the same basic technique is used to produce a different type of delivery e.g. more effort to produce a bouncer or a yorker.

- 2.2.13 Subject to the provisions of paragraph 2.2.8 above, throughout the period up to the date of receipt by the Player's Home Board of the Independent Assessment, the Player shall be permitted to continue bowling in International Cricket. At any time throughout this period the Player is subject to being called on the field by the Umpire(s) in accordance with Law 24.2 and the consequences of such Law must apply. During this period a further Match Officials' Report will however have no consequence.

- 2.2.14 In the event that the Player does not accept the conclusions of the Independent Assessment he shall be entitled to a hearing of the Bowling Review Group (BRG) as set out in paragraph 2.3 below.
- 2.2.15 In the event of a Player being reported during an ICC CWC (Men or Women), ICC World T20 (Men or Women), ICC World Test Championship, ICC CWC Qualifier or the ICC World Twenty20 Qualifier, the Independent Analysis shall be carried out and the Independent Assessment furnished on an expedited basis. In this respect, every reasonable effort shall be made for the Independent Analysis to be carried out and the Independent Assessment furnished within a period of 7 days from the date of receipt of the Match Officials' Report.

2.3 Bowling Review Group Hearing

- 2.3.1 Upon receipt of an application for a BRG hearing in accordance with paragraph 2.3.2 below, the ICC shall appoint a BRG as follows:
- The BRG shall comprise the following persons: A current member of the ICC Code of Conduct Commission (in the Chair and with the casting vote only), a current ICC referee, an ex-international player, an ex-international umpire and a human movement specialist. The ICC General Manager – Cricket shall be an ex-officio member of the BRG.
 - The Chairman of the ICC Cricket Committee shall be responsible for appointing the Chairman of the BRG from the current members of the ICC Code of Conduct Commission. Once appointed, the Chairman of the ICC Cricket Committee and the Chairman of the BRG shall be responsible for selecting the other members of the BRG in accordance with paragraphs 2.3.1 c), d) and e) below.
 - The ex-international player and umpire shall be appointed from the list of Full Member Boards' bowling advisors established in accordance with paragraph 5.1 below.
 - The human movement specialist shall be appointed from the ICC panel of human movement specialists referred to in paragraph 2.2.2 above. The human movement specialist shall not be the Appointed Specialist.
 - It is preferable that at least one of the BRG shall be a qualified legal practitioner. In the event of the BRG, as appointed in accordance with the above provisions, not including a legal practitioner then a legal practitioner shall be appointed to the BRG in an advisory capacity only and he shall not have a vote.
 - The quorum for any hearing of the BRG shall be four persons provided that the Chairman and the human movement specialist shall be included therein.
 - No member of the BRG shall be domiciled in the country which the Player represents in International Cricket.
- 2.3.2 The Player seeking a hearing of the BRG shall lodge with the ICC Head of Legal written notice thereof within 14 days of the date of receipt by the Player's Board of the Independent Assessment. The BRG hearing will be held as soon as reasonably possible and, in any event, within 21 days of receipt by the ICC of the Player's written notice referred to above.

- 2.3.3 The BRG hearing shall be held in person and not by telephone or video conference, although the BRG may, in its discretion, admit evidence at the hearing in any form.
- 2.3.4 The ICC shall be responsible for arranging the appointment of the BRG in accordance with paragraph 2.3.1 above and for determining in consultation with the Chairman of the BRG the time and place for the hearing. The ICC shall ensure that the Player, through the Player's Home Board, is given reasonable notice thereof.
- 2.3.5 The Player shall attend the hearing. However, if the Player has received notice of the hearing in terms of paragraph 2.3.4 above and fails to attend the hearing, the hearing may at the absolute discretion of the Chairman of the BRG, proceed in the absence of the Player.
- 2.3.6 The Player shall be entitled to a representative who shall be entitled to attend the hearing.
- 2.3.7 The BRG hearing shall be conducted in accordance with the usual principles of natural justice.
- 2.3.8 The BRG will consider the following:
- The video evidence referred to in paragraph 2.1.5 above.
 - The Match Officials' Report.
 - The Independent Assessment together with any image based evidence accompanying such assessment.
 - Any further evidence that the Player and/or his representative wishes to present in the Player's defence. This may include a written report, a verbal submission, any expert evidence and image based evidence.
 - Any written or video evidence that the Player's Home Board wishes to be considered on behalf of the Player.
- 2.3.9 The Player and/or his representative shall be entitled to question any person called to give evidence in the course of the hearing on any issue relevant to the hearing. The members of the BRG shall be entitled to question the Player and/or any person called to give evidence on the Player's behalf.
- 2.3.10 After all the evidence and argument has been presented, the BRG shall adjourn the hearing to deliberate on its decision.
- 2.3.11 The BRG shall reach a decision by a simple majority vote. The Chairman of the BRG has the casting vote.
- 2.3.12 The BRG shall decide whether or not the Player has an Illegal Bowling Action and that (i) the suspension of, or the Warning to, the Player be maintained, or (ii) the suspension of, or the Warning to, the Player be lifted. The BRG must, in each case, set out the reasons why the decision has been reached, including a summary of the evidence on which the decision was based.
- 2.3.13 The ICC will communicate the decision of the BRG in writing to the Player, through his Home Board, within 48 hours of the hearing being adjourned in accordance with paragraph 2.3.10 above.
- 2.3.14 Subject to the right of the Player to re-assessment in accordance with paragraph 2.4 below, the decision of the BRG shall be final and binding.

2.4 Re-assessment of Player's bowling action

- 2.4.1 A Player who has been suspended from bowling in International Cricket under these Regulations shall be permitted under the supervision and with the consent of his Home Board to continue to play domestic cricket.
- 2.4.2 Subject to the provisions of paragraph 2.4.5 and paragraph 2.5 below, a Player who has been suspended from bowling in International Cricket under these Regulations, may at any time apply to the ICC for a re-assessment of his bowling action.
- 2.4.3 Such re-assessment shall be carried out in the same manner as the Independent Analysis referred to in paragraph 2.2 above save that the purpose of the comparison between the re-assessed action and the action of the Player as employed in the Match in which he was reported shall be to determine the extent, if any, of the improvement to his bowling action.
- 2.4.4 In the event of such re-assessment concluding that the Player has remedied his bowling action and that his bowling action is no longer an Illegal Bowling Action the Player's suspension shall be lifted and he shall be permitted to continue bowling in International Cricket forthwith.
- 2.4.5 The BRG shall have the discretion to specify a fixed period before the expiry of which the Player shall not be entitled to approach the ICC for a re-assessment of his bowling action in terms hereof. Such discretion shall only be exercised in the instance of a frivolous application for a BRG hearing and the maximum period so specified shall be 1 year.
- 2.4.6 The Independent Assessment resulting from the re-assessment will stand in the place of the original Independent Assessment, and the provisions of paragraphs 2.2.10, 2.2.11, 2.2.12 and 2.2.14 and paragraph 2.3 will apply in respect of it.

2.5 Second and further reports

In the event of a Player being suspended from bowling in International Cricket under these Regulations for a second time within a period of 2 years from the date of the commencement of the first period of suspension, the Player shall be suspended from bowling in International Cricket for a minimum period of 1 year. Only after the expiry of this 1 year period will the Player be entitled to approach the ICC for a re-assessment of his action in accordance with paragraph 2.4 above. (See also paragraph 2.2.12 above)

2.6 Costs

- 2.6.1 The ICC will be responsible for the costs of the Independent Analysis and Assessment as well as the costs of the BRG hearing, including the costs incurred by the Player to attend thereat.
- 2.6.2 The Player and/or his Home Board shall be responsible for the payment of any costs of representation of the Player and for any subsequent re-assessments carried out at the Player's request.

3 MATCHES OTHER THAN TESTS, ONE-DAY AND TWENTY20 INTERNATIONAL MATCHES

If in a Match as set out in paragraph 1.1.1 (b) above, a Player is called by an Umpire under the provisions of Law 24.2 or is suspected by an Umpire or Match Referee of bowling with an Illegal Bowling Action, the following procedure shall apply.

Note: Umpires and Match Referees, in deciding whether to cite a Player under these Regulations, should use the naked eye viewing the relevant Player's bowling action live. Slow motion video footage should only be used to confirm initial suspicions.

3.1 Reporting procedure

- 3.1.1 At the conclusion of the relevant Match, the Umpire(s) and/or Match Referee shall write a Match Officials' Report detailing their concerns about the bowling action of the relevant Player, including, where relevant, whether those concerns relate to the Player's bowling action generally or whether they relate to one or more specific types of delivery.
- 3.1.2 If the Match Officials' Report is written by the Umpire(s) it shall be passed to the Match Referee.
- 3.1.3 Within 48 hours of the conclusion of the Match in which the Player is reported (within 24 hours in respect of a Match in the ICC CWC Qualifier, ICC World Twenty20 Qualifier and the ICC U19 CWC), the Match Referee shall furnish the Player's team manager and the ICC with a copy of the Match Officials' Re-port.
- 3.1.4 Once the Player's team manager and the ICC have been furnished with a copy of the Match Officials' Report and within 24 hours thereof, the Match Referee, through the ICC, shall make a media statement to the effect that the Player has been reported and that he will be subject to the ICC review process as set out herein.
- 3.1.5 Upon receipt of the Match Officials' Report from the Match Referee, the ICC shall immediately write to the Player's Home Board confirming that the Player has been cited for a suspected Illegal Bowling Action and enclosing a copy of the Match Officials' Report.
- 3.1.6 Such written confirmation referred to in paragraph 3.1.5 above shall require the Player to submit to, and the Player's Home Board to carry out, an analysis of that Player's bowling action (Home Board Analysis) as provided for below.

3.2 Home Board Analysis

- 3.2.1 If a Player is reported in accordance with paragraph 3.1.1 above, he shall be required to submit to an analysis of his bowling action which shall be carried out as follows:
 - 3.2.2 The Home Board Analysis shall be conducted by the group of bowling advisors appointed by the Player's Home Board in accordance with paragraph 5.1 below.
 - 3.2.3 The Home Board Analysis shall be carried out as soon as reasonably possible and the Player's Home Board shall furnish the ICC with a written report (Home Board Assessment) of the outcome of such analysis within 21 days of the receipt of the confirmation referred to in paragraph 3.1.6 above. See paragraph 3.2.9 below for Players reported during ICC events.

- 3.2.4 The Home Board Analysis need not involve the detailed analysis as prescribed in the ICC Standard Analysis Protocols but should as a minimum involve a genuine effort to assess the legality of the Player's bowling action taking into account the provisions of Law 24.3 of the Laws of Cricket and using the experience and technical bowling expertise of the appointed group of bowling advisors.
- 3.2.5 Where the Home Board fails to furnish a Board Assessment within the period prescribed in paragraph 3.2.3 above and remains in default of this provision despite notice by ICC requiring the Home Board to comply with this provision within a period of 10 days from the date of such notice, the Player shall automatically be suspended from bowling in International Cricket from the date of expiry of such notice period until such time as a Home Board Assessment has been properly furnished.
- 3.2.6 Where the Home Board Assessment concludes that the Player employs a legal bowling action, the Player shall be permitted to continue bowling in International Cricket.
- 3.2.7 Where the Home Board Assessment concludes that the Player employs an Illegal Bowling Action, the Player shall be immediately suspended from bowling in any International Cricket until such time as a further Home Board Assessment concludes that he has remedied his action.
- 3.2.8 Subject to the provisions of paragraph 3.2.5 above, throughout the period up to the date of receipt of the Home Board Assessment, the Player shall be permitted to continue bowling in International Cricket. At any time throughout this period the Player is subject to being called on the field by the Umpire(s) in accordance with Law 24.2 and the consequences of such Law must apply. During this period a further Match Officials' Report will however have no consequence.
- 3.2.9 In the event of a Player being reported during the ICC CWC Qualifier, ICC World Twenty20 Qualifier or the ICC U19 CWC, the Home Board Analysis should be carried out and the Home Board Assessment furnished on an expedited basis. In this respect, every reasonable effort shall be made for the Home Board Analysis to be carried out and the Home Board Assessment furnished within 7 days from the date of receipt of the Match Officials' report.

3.3 ICC analysis

- 3.3.1 If a Player, having been reported for a suspected Illegal Bowling Action under paragraph 3.1.1 above but having been permitted to continue bowling in International Cricket following a Home Board Assessment concluding that his action is a legal action (following remedial action or otherwise), is reported under these Regulations a second time within a period of 2 years from the date of the first report, the ICC shall immediately write to the Player's Home Board confirming that a second report has been received and requiring the Player to submit to an analysis by the ICC (ICC Analysis) of his bowling action, as provided for below (See also paragraph 3.5.3 below – right to invoke procedure under paragraphs 2.2, 2.3 and 2.4):
- 3.3.2 The ICC Analysis shall be conducted by the ICC High Performance Manager (or the ICC Chief Referee should the High Performance Manager be part of the panel appointed under paragraph 4 below that has reported the Player) and a member of the panel of human movement specialists appointed in terms of paragraph 2.2.2 above.

- 3.3.3 The ICC Analysis shall be carried out as soon as reasonably possible but, in any event, within 21 days of receipt by the Player's Home Board of the confirmation referred to in paragraph 3.3.1 above. See paragraph 3.3.11 below for Players reported during an ICC event.
- 3.3.4 The ICC shall be responsible for arranging the time and place for the ICC Analysis and shall ensure that the Player, through the Player's Home Board, is given reasonable notice thereof.
- 3.3.5 The ICC Analysis need not involve the detailed analysis as prescribed in the ICC Standard Analysis Protocols but should, as a minimum, involve a genuine effort to assess the legality of the Player's bowling action taking into account the provisions of Law 24.3 and using the experience and technical expertise of the persons appointed to conduct the review. The Player's bowling action should be reviewed in both a practice and match environment.
- 3.3.6 In the event of the Player failing to submit to an ICC Analysis as required above, such failure will be regarded as an admission that he bowls with an Illegal Bowling Action and he shall be immediately suspended from bowling in International Cricket until such time as he so submits.
- 3.3.7 The persons appointed under paragraph 3.3.2 above to conduct the ICC Analysis, shall furnish a written report to the ICC Cricket Operations Manager (ICC Assessment) within 7 days of the conclusion of the ICC Analysis. The ICC Cricket Operations Manager shall upon receipt of the ICC Assessment immediately write to the Player's Home Board enclosing a copy of the ICC Assessment and confirming the outcome thereof. See paragraph 3.3.11 below for Players reported during ICC events.
- 3.3.8 Where the ICC Assessment concludes that the Player employs a legal bowling action, the Player shall be permitted to continue bowling in International Cricket.
- 3.3.9 Where the ICC Assessment concludes that the Player employs an Illegal Bowling Action, the Player shall be immediately suspended from bowling in any International Cricket for a period of 12 months. The suspension shall become operative from the date of receipt by the Player's Home Board of the confirmation referred to in paragraph 3.3.7 above.
- 3.3.10 Throughout the period up to the date of receipt of the ICC Assessment by the Player's Board, the Player shall be permitted to continue bowling in International Cricket. At any time throughout this period the Player is subject to being called on the field by the Umpire(s) in accordance with Law 24.2 of the Laws of Cricket and the consequences of such Law must apply. During this period a further Match Officials' Report will however have no consequence.
- 3.3.11 In the event of a Player being reported during the ICC CWC Qualifier, ICC World Twenty20 Qualifier or the ICC U19 CWC, the ICC Analysis should be carried out and the ICC Assessment furnished on an expedited basis. In this respect, every reasonable effort shall be made for the ICC Analysis to be carried out and the ICC Assessment furnished within 7 days from the date of receipt of the Match Officials' report.

3.4 Costs

The Player's Home Board shall be responsible for the costs of the ICC Analysis which costs shall include the reasonable accommodation and travel costs of the persons appointed to the review panel as well as the professional fees of the human movement specialist.

3.5 Right of appeal against ICC assessment and right to re-assessment

- 3.5.1 Any Player who has been suspended from bowling from International Cricket in accordance with paragraph 3.3.9 above, shall, subject to the provisions of paragraph 3.5.2 and 3.5.3 below, have no right to a re-assessment of his bowling action or of appeal against the outcome of the ICC Assessment.
- 3.5.2 Upon the expiry of the 12 months suspension period referred to in paragraph 3.3.9 above, the Player shall be automatically eligible to bowl in International Cricket and no application for re-assessment shall be necessary.
- 3.5.3 Furthermore, upon being notified of the second report referred to in paragraph 3.3.1 above or of the period of suspension referred to in paragraph 3.3.9 above, the Player's Home Board may elect, at its cost, to follow the procedure outlined in paragraphs 2.2, 2.3 and 2.4 of these Regulations. In such a case, all costs including the costs of the Independent Analysis, any Bowling Review Group Hearing and any re-assessments shall be for the account of the Player's Home Board.

4 ICC U19 CRICKET WORLD CUP AND CWC QUALIFIER

- 4.1 The ICC shall appoint an event bowling action review panel to attend each ICC U19 Cricket World Cup and CWC Qualifier (the Events).
- 4.2 The appointed panel shall consist of a member of the ICC panel of human movement specialists referred to in paragraph 2.2.2 above and two other bowling experts of suitable bowling or coaching experience.
- 4.3 This panel shall be responsible for identifying, in consultation with the Match officials appointed to the Events, any Players with suspected Illegal Bowling Actions.

Note: The panel (and Match officials), in deciding whether to cite a Player as set out above, should use the naked eye viewing the action live and/or on television at normal speed. Slow motion television replays should only be used to confirm initial suspicions.

- 4.4 At the conclusion of the Event, the panel shall submit a report to the ICC detailing its concerns about the bowling actions of any Players so identified.
- 4.5 Such report(s) shall be dealt with by the ICC in the same way as it would deal with a Match Officials' Report furnished to the ICC under the provisions of paragraphs 2.1.1 or 3.1.1 above and any Players so cited shall be treated in accordance with the procedures set out in paragraphs 2 or 3 above (as the case may be) save that the expedited procedures referred to in paragraphs 2.2.15, 3.2.9 and 3.3.11 shall not apply.

5 ICC MEMBER BOARDS POLICY

Each ICC Member Board shall formulate and implement a policy and strategy to deal with players with suspected Illegal Bowling Actions in its domestic cricket. Such policy and strategy shall as a minimum requirement:

- 5.1 Establish a group of bowling advisors comprising the following persons: An ex-international fast bowler, an ex-international spinner, an ex-international umpire and, if available, a human movement specialist. The persons appointed shall be the best available and shall preferably have appropriate coaching experience.

- 5.2 Establish a mechanism for identifying bowlers with suspected Illegal Bowling Actions. Primary responsibility for this shall be the umpires. In addition, for all national age group tournaments, a bowling action review panel (similar to the panel appointed in accordance with 4.2 above) shall be appointed by the Member Board to attend such tournaments with the task of identifying any players with suspected Illegal Bowling Actions.

Note: Umpires and those responsible for identifying players with suspected Illegal Bowling Actions, in deciding whether to cite a player as set out above, should use the naked eye viewing the bowling action live and/or on television at normal speed. Slow motion television replays should only be used to confirm initial suspicions.

- 5.3 Require that having identified a player with a suspected Illegal Bowling Action be it by way of an umpire's report or otherwise, such player shall be referred to the Member Board's group of bowling advisors for analysis and assessment.
- 5.4 Require that any player reported in accordance with this process shall not be selected by the Member Board as a player for any national representative team until such time as his bowling action has been assessed in accordance with paragraph 5.3 above and, in the event of such assessment confirming that the player has an Illegal Bowling Action, until such time as his bowling action has been remedied.

6 ICC ILLEGAL BOWLING ACTIONS DATABASE

The ICC shall be responsible for maintaining a database in which the names of all Players cited under these Regulations and the details and status of any Analysis and Assessments carried out in consequence thereof are recorded.

ANNEXURE 1

ICC Standard Analysis Protocols

Biomechanical Analysis of a Bowling Action

1 INTRODUCTION

The ICC has introduced a revised process for the review of Players with suspected Illegal Bowling Actions (Bowling Review Process).

In order for the Bowling Review Process to be conducted in a fair and consistent manner, the following standard protocols for the collection of data and the assessment and analysis of bowling actions have been introduced.

The overall purpose of the report is to confirm the legality / or not, of the bowling action used by the relevant Players in Matches. Thus, the protocols are provided not only for how the bowling action should be analysed in the laboratory setting, but also highlight the need for a detailed comparison between the bowling action performed during the Match in which a Player was cited and the bowling action analysed in the laboratory.

The ICC has determined that it is the degree of elbow extension, as opposed to hyperextension or abduction / adduction that is prohibited. Elbow hyperextension and elbow abduction / adduction are involuntary movements that cannot be controlled by the individual during the bowling action. (See Paragraph 5.3 & Appendix A)

The conclusion of the report should be that having analysed the bowling action in the laboratory and having compared it to the bowling action as used in the supplied Match footage, in the opinion of the expert, the Player has faithfully reproduced his Match technique in the laboratory. A statement concerning the legality of the bowling action with respect of the amount of elbow extension measured and the 15 degree elbow extension tolerance threshold should then follow.

2 VIDEO FOOTAGE FROM MATCH IN WHICH PLAYER CITED

The television video footage of the entire bowling spell(s) of the Player in the Match where the report was made shall be presented on a master tape. (ICC to supply Match footage. If possible, rear, frontal and lateral views of the action shall be provided.)

The master tape shall be converted to 50Hz / 60Hz (standard television footage is recorded at 25Hz) to enable more accurate evaluation of the Player's bowling action on the day the Player was actually cited.

Descriptive analysis during the Match footage should compare the actions of the Players e.g. positioning of feet, angle of run up, position of the torso, velocity of arm, velocity of delivery (95% of Match speed etc). These comparisons should be clearly presented in the report.

3 ANTHROPOMETRIC ASSESSMENT

(Both the bowling & non-bowling arms) See Appendix A

Carry Angle: The angle between the longitudinal axis of the upper arm and forearm, in the frontal plane. Note: The average range of carry angle for the human population is between 5°-15°.

Hyperextension Angle: The angle between the longitudinal axis of the upper arm and forearm, in the sagittal plane. (i.e. beyond full normal extension): Two measurements are required: a passive measurement, where there is no force applied and a second measurement where 'reasonable' force is applied.

When the second measurement for the hyperextension angle is measured, the Player is required to extend his arm back as far as possible. This is achieved by applying a „reasonable’ force, essentially the body weight of the bowler, leaning on each arm.

Additional Physical Measurements: Height, weight and assessment of general mobility of the shoulder, elbow and wrist joints.

History of Previous Injuries: A brief history of previous injuries should be determined as an aid in the biomechanical assessment - particular focus should be brought to the elbow and shoulder joints.

4 BOWLING ANALYSIS (INDOORS – LABORATORY CONDITIONS)

All biomechanical assessment shall be carried out with the Player bowling off his normal full run-up, on a correct length cricket pitch.

A minimum of three synchronised cameras (using optio reflective markers) operating at a minimum of 200 frames per second and a maximum of 250 frames per second (preferable) should be used to collect the data. The cameras and computer to be operated and positioned in appropriate positions to facilitate a subsequent three-dimensional analysis of the shoulder, elbow, wrist and ball.

Video data (50fps) should also be collected in order to allow synchronisation with the optio reflective computer animation data’. A minimum shutter speed of 1000Hz is required to prevent blurred images.

Calibration and accuracy procedures must be undertaken in the delivery space prior to data collection. Accuracy analysis should indicate that the 3D methods employed are accurate to within $\pm 1^\circ$ (Note: A rigid bar (1m in length), with markers representing the shoulder, elbow and wrist (180°) can be used in the calibration procedures. The rod must be rotated in the same manner as a bowling arm. This should be repeated using a rigid bar representing a 160° angle. Accuracy analysis should again indicate that the 3D methods employed are accurate to within $\pm 1^\circ$).

Optimal “levels of filter” must be used in the laboratory process. Ideally a laboratory environment using opto-reflective marker system will produce the environment with the least amount of error (Noise) and therefore less filtering can be used. This value or cut off frequency is calculated via the residual analysis method presented by Winter (1990) – (See Appendix B)

Warm up (player’s own) – but must include the bowling of a number of deliveries at Match pace prior to data collection. The Player to have no clothing on the torso, in order to enable the correct marker set to be placed on the bowling arm. (See Appendix C) Automatic digitisation of the marker set will enable joint centres to be determined during each delivery.

In respect of a fast bowler, six „normal’ – good length deliveries, six ‘yorkers’ and six ‘bouncers’ must be recorded. Six deliveries of each spin variation for the leg or off spin bowler must be recorded. Standard video cameras should be used to assess the position the ball lands, along with the amount of bounce and turn created with each delivery. This video should also be presented in the report.

Three-dimensional analysis of the bowling arm to begin from back foot contact, to include ‘arm horizontal’ maximum flexion, ball release and a minimum of 10 frames after ball release for each successful delivery.

The UPPER Arm is in the horizontal position in Figure 1b. “The horizontal position” i.e. The upper arm being level with shoulder and parallel to the ground.

The point of release is defined as the FIRST frame the BALL and HAND are NOT in contact. This is important as the exact time (frame – 250Hz) of release can potentially change results by three or four degrees. A marker (a piece of reflective tape) on the ball, a change in velocity of the ball, along with 50Hz video may all help with this process.



Copyright © 2003 Quintic Consultancy Ltd. All Rights Reserved

Figure 1a: Arm Horizontal – NO



Copyright © 2003 Quintic Consultancy Ltd. All Rights Reserved

Figure 1b: Arm Horizontal – YES

Every effort must be made to ensure that the Player is bowling as close to Match pace as possible. This can be measured after each delivery if the equipment is available (Radar Gun), or measured via the 3D data during analysis. If deliveries are not at a suitable speed (so as to represent Match conditions) then the data shall be invalid

5 PRESENTATION OF RESULTS

A summary of the results of each delivery to be presented in graphical or table format.

The presentation of the three-dimensional analysis of the bowling arm to begin from a minimum of 10 frames before the arm reaches horizontal, to include 'arm horizontal', 'maximum flexion', 'ball release' and a minimum of 10 frames after ball release.

The 'flexion-extension' and the 'abduction-adduction' curves should be presented separately. This data should be presented in graphical form. (The hyperextension component will show up in the flex-ext curve if it is present and there is no need to separate it. If it is present it will be shown as the curve going beyond 180 degrees or below 0 degrees, depending on which represents "straight arm")

The six trials for each type of delivery (e.g. Bouncer / Normal Length / Yorker), along with the average should be plotted on the same graph (i.e. 3 graphs, one each for the bouncer, normal length and yorker deliveries) to show conformity.

The average of the different types of delivery (e.g. Bouncer / Normal Length / Yorker) to be displayed along with the standard error reading.

Ball release speeds to be presented for each delivery.

Stick figure representation, to include pictures of the various key positions to aid in the presentation of the results. (Alternatively, an avi file may be provided.)

6 ACCEPTABLE LEVEL OF ELBOW EXTENSION

This should be set at a maximum of 15 degrees 'Elbow extension' for all bowlers and types of deliveries. This specifically refers to extension of the forearm relative to the upper arm to the straight position. Elbow hyperextension or adduction is not included in the 15-degree tolerance threshold. It should be noted that in order for the action to be classified as a legal action, the degree of 'elbow extension' recorded for each delivery should be within the 15 degree limit.

APPENDIX A - MOVEMENTS

Flexion - This movement takes place about a transverse axis and is a description of the movement that occurs when you move your arm forward. It is described as the approximation (moving closer together) of two ventral surfaces of the body e.g. flexing the elbow joint. There are a number of situations where this rule doesn't seem to apply e.g. at the ankle where the terms dorsi and plantar flexion are used to avoid confusion.

Extension - This movement is the opposite of flexion; it also takes place about a transverse axis and occurs when you approximate two dorsal surfaces e.g. straightening the elbow.

Hyperextension - An abnormal movement beyond the normal limit of extension, such as more than the 180 degrees of extension of the knee or elbow joints.

Abduction and Adduction - These movements take place about an antero-posterior axis and occur when the arm is taken sideways away from the body (abduction) and returned from such a position to the side of the body (adduction).

APPENDIX B - FILTER LEVEL

When measurements are made using image-based analysis systems (Video and/or Automatic Tracking) they are contaminated with 'Noise' generated during the recording and digitising procedures. The sample signal can be considered to be the sum of the true signal, systematic noise and the random noise. The 'TRUE' signal can never be deduced from the measurements; only the best estimate of the signal.

There have been a number of techniques developed for the reduction of noise, including Butterworth filters, Quintic splines and cross-validated splines. Each of these techniques uses a mathematical function to approximate the data. The precise frequency components of the true signal are rarely known in sports biomechanics and some procedures must be adopted for the determination of the cut-off filter, or other smoothing parameter. The less noise in the system, the closer the raw data will represent the 'TRUE' signal, and the less smoothing will be required.

Ideally a laboratory environment using opto-reflective marker system will produce the environment with the least amount of error (Noise) and therefore a lower filtering value can be used. Optimal "levels of filter" must be used in the laboratory process. This value or cut off frequency is to be calculated for all bowling analysis using the residual analysis method presented by Winter (Biomechanics and Motor Control of Human Movement, 2nd edition, Wiley and Sons Publisher, 1990).

Previous work in this area has identified a Butterworth digital filter level of 12 – 14 Hz and a Woltring MSE of 20 – 25 cine appropriate. However a residual analysis, should be conducted for the bowler being analysed to derive the optimum filter level for the current data. Any significant different optimum filter level derived from the above values needs to be well justified and documented. Raw data should be graphed with filtered data and inspected by the expert to ensure the filtered curve closely reflects the raw data. These should be presented in the appendix to the report as background technical information for each analysis

APPENDIX C - MARKER SET

Cricket Upper Limb Model

The following guidelines are established to ensure conformity of elbow joint data across laboratories. Establishment of joint centres at the shoulder, elbow and wrist joints are therefore integral to this process.

Shoulder Joint

This joint centre should be determined from the recording of markers anterior, posterior and superior (acromion process) to the “joint centre of rotation”. The anterior and posterior markers should be placed such that a line between the two represents the shoulder axis of rotation (approximate midline of the upper arm). The shoulder joint centre (SJC) is then calculated as the centre of these three markers or from where a vertical line dropped from the acromion intersects the line between the anterior and posterior markers.

The position of the calculated SJC is then recorded in a static trial relative to the coordinate system of the triad located on the upper arm. During a bowling trial the SJC can then be reconstructed relative to the position of the upper arm triad during every frame. Optimisation or helical axis techniques may be used to calculate the shoulder centre, which may modify the markers used about this joint.

Elbow Joint

The elbow joint centre may be calculated using markers placed on the lateral and medial elbow epicondyles or using “epicondyle pointer trials” with the elbow flexed to 90°. If a marker based approach is used the markers should be as small as the resolution of the opto-electronic camera system will allow. Generally markers no bigger than 15mm in diameter are preferable. The position of the epicondyles should be reported with reference to a triad of markers placed on the upper arm. The elbow joint centre is then calculated as the mid point between these two reconstructed epicondyle virtual markers. This means that no joint markers are required during bowling trials to reduce errors associated with skin movement. The cameras only need to track the upper arm triad during the bowling action to know where the elbow and shoulder joint centres are. For a background reading in this area refer to Lloyd et al., (*Journal of Sports Sciences*, 2000, v12). Helical axis determination may also be applied at the elbow joint.

Wrist Joint

The wrist joint centre may be calculated using “pointer trials” or by placing markers on the styloid processes at the wrist during a static trial. If a marker based approach is used the markers should be as small as the resolution of the opto-electronic camera system will allow. Generally markers no bigger than 15mm in diameter are preferable. The position of the styloid processes should be calculated as reference points (i.e. three-dimensional co-ordinates) to a triad of markers placed on the forearm. This triad needs to be placed relatively close to the wrist joint centre to avoid excessive skin movement during pronation / supination. The markers on the styloid processes can then be removed prior to bowling data collection. The wrist joint centre is then calculated as the mid point between the styloid process markers or landmarks from the pointer trials.

CLOTHING AND EQUIPMENT RULES AND REGULATIONS

CLOTHING AND EQUIPMENT RULES AND REGULATIONS

A PREFACE

- 1 The objectives which ICC seeks to achieve through these regulations are:
 - a) To ensure a consistent approach and to treat all Member Boards equally;
 - b) To ensure professional and appropriate standards of appearance of players and team officials;
 - c) To protect the sponsorship rights of ICC and its Member Boards (including from ambush marketing);
 - d) To allow an opportunity for players to obtain some revenue from controlled bat advertising;
 - e) To prohibit advertising connected with betting and/or gaming.
- 2 These regulations are effective as from the 1st October 2013 and should be read in conjunction with Appendix 1, which sets out in diagrammatic form what marks and logos are permitted in what size and positions on particular items of cricket clothing and equipment in all formats of the game.

B DEFINITIONS

- 1 **Betting Logo** – a Logo which is either perceived, or likely to be perceived, by spectators and viewers, as being associated or connected in some way with betting, gaming or gambling of any kind.
- 2 **Charity Logo** – a Logo of an officially registered charity of a Member Board's choice.
- 3 **Commercial Logo** – an ICC Approved Logo of an entity which is the sponsor of a series, event, team or player.
- 4 **Cricket Clothing** – shirts, T-shirts, skins, trousers, sweaters, caps, hats, helmets, wristbands, headbands, sunglasses or other headgear.
- 5 **Cricket Equipment** – stumps, bats, pads, boots, shoes, gloves (batting or wicket-keeping), thigh pads, arm guards and other visible protective equipment.
- 6 **Event Logo** – an ICC Approved Logo of an international cricket event, which may include (but not consist solely of) a Commercial Logo of the sponsors of the event.
- 7 **Excluded Events** – unless otherwise advised by ICC, in advance of an event, Excluded Event means: ICC Cricket World Cup, ICC Under 19 Cricket World Cup, ICC World Test Championship, ICC Cricket World Cup Qualifier (or replacements for any of the same), ICC World Twenty/20, ICC World Twenty/20 Qualifier, ICC Women's World Cup and the ICC Women's World Twenty/20.
- 8 **ICC Approved** – in relation to any Logo, means approved by ICC (or by ICC Development (International) Limited ("IDI") as ICC may decide) in accordance with the procedure set out in Section K below, as qualifying as a Manufacturer's Logo, a Commercial Logo, an Event Logo, a National Logo or a Player's Bat Logo (as the case may be) and as not being a Betting Logo and as being otherwise in accordance with these Regulations.

- 9 **ICC Events** – means the ICC Cricket World Cup, ICC U/19 Cricket World Cup, ICC World Test Championship, ICC World Cup Qualifier (or replacements for any of the same), ICC World Twenty/20, ICC World Twenty/20 Qualifier, ICC Women’s World Cup and the ICC Women’s World Twenty/20 and any other cricket event owned by the ICC or any of its group companies.
- 10 **Logo** – means any form of identification or branding including (without limitation) any corporate name, business name, internet domain name, title, flag, emblem, crest, mascot or trade mark (whether registered or not and including any symbol, device or colour(s) which functions or is intended to function as a trade mark).
- 11 **Manufacturer** – in relation to any item of Cricket Clothing or Cricket Equipment, “Manufacturer” shall mean any entity carrying on the business of both:
- a) manufacturing or procuring the manufacture of the Cricket Equipment or the Cricket Clothing of the type in question; and
 - b) supplying it from readily available stock for sale throughout outlets of several kinds to members of the public in a country which is a Member of ICC, with the aid of published price lists and catalogues, and with profit directly from the sale of such Cricket Clothing or Cricket Equipment as its main aim.

An entity not otherwise within this definition shall not qualify as a Manufacturer by reason of its being associated in business with, or a company in the same group of companies as a Manufacturer.

No entity shall qualify as a Manufacturer of any item of Cricket Clothing or Cricket Equipment by virtue of its involvement in the manufacture of Cricket Clothing or Cricket Equipment of any other type. In particular (but without prejudice to the generality of the foregoing), no entity shall qualify as a Manufacturer of bats by reason of its manufacture of any other item of Cricket Equipment or Cricket Clothing.

An entity which as of October 2001 qualified as a “Manufacturer” under the previous edition of these regulations but which would not otherwise qualify as a Manufacturer hereunder shall be deemed to continue to qualify as a Manufacturer provided the Logo of any such entity shall not thereby qualify as a Manufacturer’s Logo if it is a Betting Logo.

- 12 **Manufacturer’s Logo** – an ICC Approved Logo of the Manufacturer of the item of Cricket Equipment or Cricket Clothing in question excluding, however:
- a) any Logo which (notwithstanding some connection with a Manufacturer) is also (either at the time of its adoption or subsequently) a Logo of, confusingly similar to or which suggests a connection with any entity which is not a Manufacturer; and
 - b) any Betting Logo.

provided, however, that ICC may (in its sole discretion) approve as a Manufacturer’s Logo, a Logo of an entity which, although not already a Manufacturer, is nevertheless a manufacturer of sports clothing and/or sports equipment other than Cricket Clothing and Cricket Equipment.

For the purpose of these regulations (including Appendix 1), all Manufacturer's Logos shall fall into one of the following five categories:

- **Design Feature** – means any design feature of a Manufacturer which is distinctive to that Manufacturer and is used for the purposes of brand identification and/or cosmetic appeal but which does not contain any Manufacturer's Identification.
 - **Identification Strip** – a tone on tone or contrasting strip containing a Manufacturer's Identification once or repeatedly.
 - **Manufacturer's Identification** – means any express form of Manufacturer identification, including but not limited to a Manufacturer's name, model name, internet domain name, emblem, logo and/or trademark, but shall not include any Design Feature.
 - **Official Product** – means the label which identifies an item as an official product of the Manufacturer.
 - **Quality Feature** – means the label of the Manufacturer which promotes a quality feature used by the Manufacturer.
- 13 **National Logo** – an ICC Approved Logo of a country or its ICC Member Board.
- 14 **Official ICC Apparel Supplier** – means a supplier of apparel contracted by ICC or IDI, from time to time, to supply apparel to the ICC, IDI and the ICC umpires and referees.
- 15 **Player's Bat Logo** – means an ICC Approved Logo of a sponsor of a player to be carried on the player's bat; provided that such Logo shall not be either:
- a) of, or confusingly similar to, or likely to be perceived as suggesting a connection with:
 - 1) an entity which conflicts (whether through being a competitor or otherwise) with the exclusivity of any sponsor, supplier, or commercial partner of the Member Board of the player concerned or of an ICC Event; or
 - 2) a Manufacturer, other than the Manufacturer of the item of cricket equipment it is to be carried on; or
 - b) a Betting Logo.

ICC shall have the final say in determining whether any such conflict or circumstances exist and no player may pursue any action against ICC or IDI, or against his team's ICC Member Board should he be precluded from displaying a Player's Bat Logo by reason of the same.

C SCOPE OF APPLICATION

- 1 These regulations shall apply to all Test, One Day and Twenty/20 internationals played under the auspices of the ICC. Contractual agreements (for example Member Participation Agreements and Player Squad Terms) and regulations pertaining specifically to individual ICC Events should also be consulted regarding specific instructions concerning clothing and equipment at such ICC Events. Where any conflict arises between these regulations and the obligations contained in any specific ICC Event agreement and/or regulation, then the ICC Event specific agreement and/or regulations shall prevail.

Note: One example of where the regulations governing ICC Events differ from these regulations is that Player's Bat Logos, Charity Logos and Identification Strips shall not be permitted in Excluded Events. Accordingly, all players, agents, sponsors and manufacturers should ensure that they obtain a copy of any applicable agreements and/or regulations before finalising any arrangements that relate to the commercialisation of relevant cricket clothing and equipment during or in relation to any ICC Event.

- 2 These regulations govern the authorisation of clothing and equipment worn and used by players and team officials of Member Board representative teams. Sponsor advertising, manufacturer identification and the decorative rights of the Member Boards are also addressed.
- 3 The aforesaid persons are subject to these provisions when on official duty for the aforesaid matches, either on the field of play or as otherwise expressly stated.
- 4 These regulations also cover sponsor advertising and manufacturer identification on stumps.

D GENERAL PROHIBITIONS

- 1 Any clothing or equipment that does not comply with these regulations is strictly prohibited. In particular, no Logo shall be permitted to be displayed on Cricket Clothing or Cricket Equipment, other than a National Logo, a Commercial Logo, an Event Logo, a Manufacturer's Logo, a Player's Bat Logo or a Charity Logo as provided in these regulations. In addition, where any Match Official becomes aware of any clothing or equipment that does not comply with these regulations, he shall be authorised to prevent the offending person from taking the field of play (or to order them from the field of play, if appropriate) until the non-compliant clothing or equipment is removed or appropriately covered up.
- 2 It shall also be prohibited under these regulations for any individual to wear any clothing or use any equipment that has been changed, altered or transformed (whether to comply with these regulations or otherwise) in any way that, in the opinion of any Match Official, undermines the professional standards that are required of all elite players. For example, and without limitation, it shall be prohibited to cover up or alter the appearance of clothing and equipment with sticking plaster or marker pens and/or to wear batting pads painted with a coloured paint that has faded or is flaking off.

E LOGOS – GENERAL PRINCIPLES

- 1 In the case of the host team, the Commercial Logos may consist of the Event Logo and/or the Logos of up to two event, series or team sponsors. In the case of the visiting team the Commercial Logos may consist of the Logos of up to two team sponsors. For the avoidance of any doubt, no more than two sponsor names may be included in any Commercial Logo.
- 2 Subject to the limitations contained in these regulations a visiting team may display any Commercial Logo on its clothing or equipment irrespective of whether such Logos may conflict with any sponsor or supplier of the host Member Board.
- 3 The host Member Board shall not require a visiting team to wear the Event Logo without the consent of the Board of the visiting team. There shall be no obligation to give such consent, but if it is given, the visiting team must forego the use by its team sponsors of one of the two Commercial Logos.

- 4 Any Commercial Logo on clothing shall be decided by each Member Board and shall be common to and worn by each member of the team concerned. No individual Commercial Logos shall be worn by any team member, save for the carrying of a Player's Bat Logo on bats, as provided herein.
- 5 The National Logo, name of the country or national flag should not contain any advertising and must not interfere with any elements of the clothing identifying the player.
- 6 A visiting team shall abide by any law of the host country which restricts advertising of a product. No compensation shall be payable should a visiting team be precluded from displaying its Commercial Logos on Cricket Clothing or Cricket Equipment, and a visiting team shall not pursue any action against the host Member Board.
- 7 Only one Manufacturer may be identified on each article of cricket clothing.
- 8 When required to be carried by a Manufacturer, any statutory wording is to be placed on the back of a player's bat and to be of discreet design only (subject to relevant statutory provisions).

F PERSONAL MESSAGES

- 1 Players and team officials shall not be permitted to wear, display or otherwise convey messages through arm bands or other items affixed to clothing or equipment unless approved in advance by the player or team official's Board. Approval shall not be granted for messages which relate to political, religious or racial activities or causes.
- 2 Visible Tattoos (permanent or temporary) incorporating any Commercial or Manufacturers Logo shall not be permitted.

G TRAINING CLOTHING

- 1 Team Training Bibs: Shall be of a distinguishing colour to that of the playing shirts.
- 2 Only training kit (which shall include tracksuits, sweatshirts, branded T-shirts, team training bibs etc.) issued to the team by its Board (hereinafter referred to as team training kit) may be worn by the players and team officials within the precincts of the ground on match days as well as at all official team practice and training sessions.
- 3 Save for the requirement in the relevant playing conditions that squad members of the fielding team who are not playing in the match and who are not acting as substitute fielders shall be required to wear a team training bib whilst on the playing area (including the area between the boundary and the perimeter fencing). No training kit is to be worn by players on the field during the hours of play.
- 4 Subject to the provisions of paragraphs E1, E6 and G1, and the proviso that the team training kit is uniform to all members of the same team, there shall be no restriction on the colour or design of the team training kit nor on the number, positioning and size of the National, Commercial or Manufacturer's Logos thereon.

H TOSS

Players attending at the toss will be expected to be in team playing clothing. Team blazers shall be optional.

I PRESS CONFERENCES, POST- MATCH PRESENTATIONS AND TELEVISION INTERVIEWS

Players or team officials attending post match presentation ceremonies and press conferences as well as television interviews conducted during or after the match shall be expected to be in either team playing clothing, team training kit excluding vests and shorts or other appropriate team clothing.

J MEASUREMENT METHOD

Items will be measured according to their geometric shape. To calculate the surface area, items may be divided into several geometric forms. Non standard shapes will be measured as rectangles.

K ICC APPROVAL

- 1 In order for any Logo to be ICC Approved for use in any match or series of matches to which these Regulations apply, the party seeking approval (e.g. the entity claiming to be the Manufacturer in the case of approval sought for a Manufacturer's Logo) must apply to ICC for the grant of such approval as set out in clause 2 below and such approval must have been granted in advance of the commencement of the match or series in question. Once a Logo has been ICC Approved for any relevant match or series of matches, such approval shall remain effective for all other applicable matches and series thereafter until either:
 - a) such time as these Regulations may be amended or replaced in any way affecting the continuing compliance of such Logo in which case the Logo shall cease to be approved immediately unless the Logo is being used in a match or series at the time of ICC giving notice of the amendment or replacement of the Regulations or is due to be used in such a match or series within [30 days] after such notice in which case such approval will cease to apply to the Logo concerned at the end of the match or series in question; or
 - b) until ICC gives notice that the Logo is no longer ICC Approved due to it ceasing to be in compliance with these Regulations from time to time (e.g. that since the original grant of ICC Approval, the Logo has become a Betting Logo) in which case the Logo will cease to be ICC approved immediately upon ICC giving notice to that effect.
- 2 Any application to ICC for a Logo to be ICC Approved shall be sent to ICC at Dubai Sports City, PO Box 500070, Dubai, marked "Cricket Operations Department". The application shall state the type of Logo for which the approval is sought (e.g. whether a Manufacturer's Logo, a Player's Bat Logo, etc.) and shall include a sample of the Logo for the item of Cricket Clothing or Cricket Equipment to which it is proposed (subject to approval being granted) to be applied. In respect of any Logo which is required by these regulations to be within certain size parameters, the applicant must state the size which it considers such Logo to be and provide evidence of how this has been calculated. ICC retains the final say in determining whether any Logo is within the permitted parameters.

- 3 ICC will review any application for a Logo to be ICC Approved which has been received in accordance with clause 2 above and within 3 days of receipt of such application (counting from the first business day on which, or following which, the application was received and discounting any intervening days which are not regular business days – e.g. weekends and public holidays) shall respond to the applicant, acknowledging receipt of the application and, if applicable, confirming that ICC has been provided with the required information and materials or, alternatively, stating that ICC considers that it has not been provided with all requisite details/materials as set out in clause 2 above and requesting that the applicant provides the same.
- 4 ICC shall use its best endeavours (but does not undertake) to provide its final determination to the applicant for a Logo to be ICC Approved within 10 business days of its having confirmed receipt of all requisite information and materials for such application.

L BREACH OF REGULATIONS

Any player or team official in breach of these provisions shall be liable to a penalty as may be imposed under the ICC Code of Conduct for Players and Player Support Personnel. In addition, in the event of a breach of these provisions relating to any equipment or clothing issued to the players and team officials by their Board, and on receiving a report from the ICC Match Referee to this effect, the ICC Chief Executive may subsequently impose an appropriate fine, not exceeding US\$25 000, on the Board of the offending players or team officials concerned.

TEST MATCHES

PLAYING SWEATER - LONG SLEEVED

APPENDIX 1

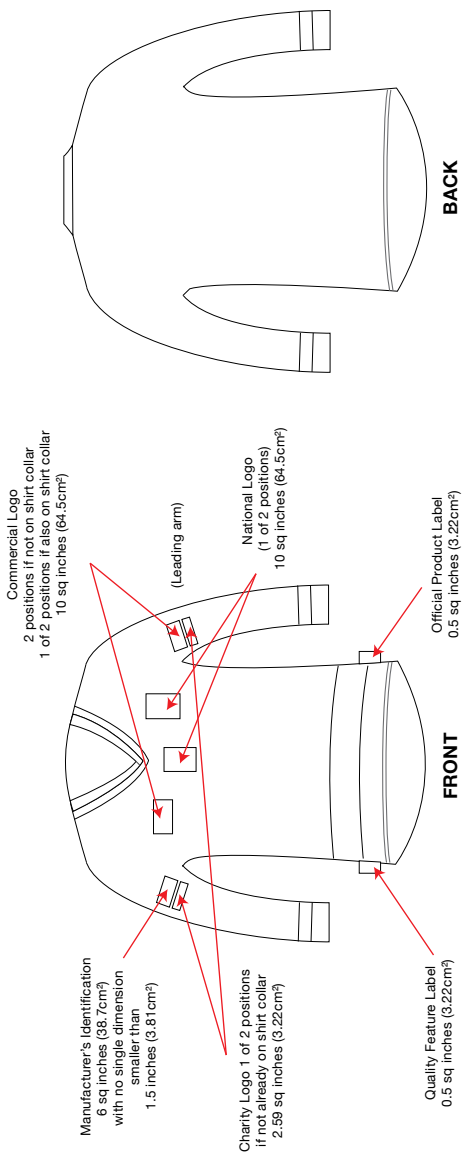

NOTE

COLOUR & DESIGN	NAME, NUMBER & INITIALS	OTHER MARKS & INSIGNIA
<ul style="list-style-type: none"> The colours and design of the sweaters shall be uniform to all members of the same team. Sweaters shall be plain white/cream, save that coloured piping or trim and stripes shall be permitted subject to the following restrictions: <ul style="list-style-type: none"> Piping is restricted to 0.5 cm (0.2 in) in width. Only one colour of piping/trim is permitted on any sweater. Piping is restricted to the sweater seams. Stripes in team colours are permitted around the waist, neck (traditional V shape) and wrist cuffs. 	<ul style="list-style-type: none"> One of the following numbers is permitted to be displayed on the long sleeved sweaters in a position immediately below the National Logo: <ul style="list-style-type: none"> Indicating a player's order of selection for his country, or Indicating the number of caps earned by a player for his country, or Indicating a player's landmark achievement (50, 100, 150 Tests etc.). Such numbers shall not be more than 2 cm (0.78 in) in height. A player's initials may be displayed on the chest or sleeve of the long sleeved sweater. Such initials shall not be more than 2 cm (0.78 in) in height. 	<ul style="list-style-type: none"> Players representing Member Boards who have won the ICC Test Play-off may display a symbol on the sweater for each of the occasions that this has been achieved. No restrictions on position. Each symbol shall not exceed 1 sq cm in size. The name of the opposing touring team or the name of the country being toured as well as the year of such tour may be displayed on the chest of the sweater immediately below the National Logo provided such numbers and letters shall not exceed 1 cm (0.4 in) in height.

TEST MATCHES

PLAYING SWEATER - SLEEVELESS

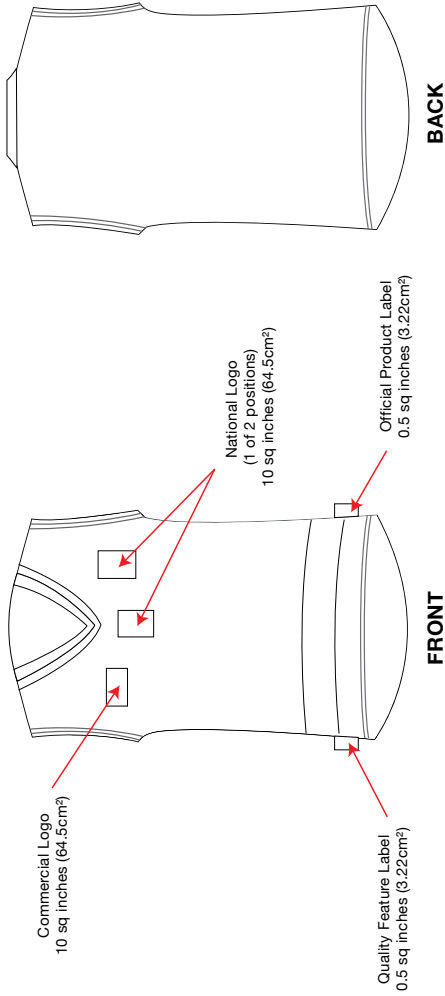

NOTE

COLOUR & DESIGN	NAME, NUMBER & INITIALS	OTHER MARKS & INSIGNIA
<ul style="list-style-type: none"> The colours and design of the sweaters shall be uniform to all members of the same team. Sweaters shall be plain white/cream, save that coloured piping or trim and stripes shall be permitted subject to the following restrictions: <ul style="list-style-type: none"> Piping is restricted to 0.5 cm (0.2 in) in width. Only one colour of piping/trim is permitted on any sweater. Piping is restricted to the sweater seams. Stripes in team colours are permitted around the waist and neck (traditional V shape). 	<ul style="list-style-type: none"> One of the following numbers is permitted to be displayed on the sleeveless sweaters in a position immediately below the National Logo: <ul style="list-style-type: none"> Indicating a player's order of selection for his country, or Indicating the number of caps earned by a player for his country, or Indicating a player's landmark achievement (50, 100, 150 Tests etc.). Such numbers shall not be more than 2 cm (0.78 in) in height. A player's initials may be displayed on the chest of the sleeveless sweater. Such initials shall not be more than 2 cm (0.78 in) in height. 	<ul style="list-style-type: none"> Players representing Member Boards who have won the ICC Test Play-off may display a symbol on the sweater for each of the occasions that this accomplishment has been achieved. No restrictions on position. Each symbol shall not exceed 1 sq cm in size. The name of the opposing touring team or the name of the country being toured as well as the year of such tour may be displayed on the chest of the sleeveless sweater immediately below the National Logo provided such numbers and letters shall not exceed 1 cm (0.4 in) in height.

TEST MATCHES PLAYING SHIRT

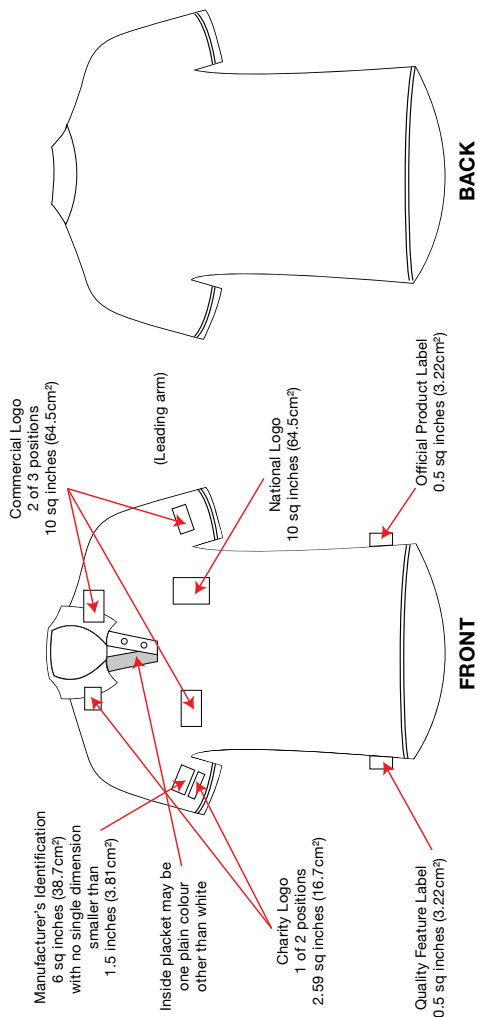

NOTE

COLOUR & DESIGN	NAME, NUMBER & INITIALS	OTHER MARKS & INSIGNIA
<ul style="list-style-type: none"> The colours and design of the shirts shall be uniform to all members of the same team. Playing shirt sleeves may be cut to any length, as long as both sleeves are evenly trimmed and the edges are sewn and hemmed. Playing shirts shall be plain white/cream, save that coloured piping or trim shall be permitted subject to the following restrictions. <ul style="list-style-type: none"> Piping is restricted to 0.5 cm (0.2 in) in width. Only one colour of piping/trim is permitted on any shirt. Piping is restricted to the edge of the shirt collar, shirt seams and cuffs. The inside of the placket may be of a plain colour other than white. 	<ul style="list-style-type: none"> One of the following numbers is permitted to be displayed on the playing shirts in a position immediately below the National Logo: <ul style="list-style-type: none"> Indicating a player's order of selection for his country, or Indicating the number of caps earned by a player for his country, or Indicating a player's landmark achievement (50, 100, 150 tests etc.). Such numbers shall not be more than 2 cm (0.78 in) in height. A player's initials may be displayed on the chest or sleeve of the playing shirt. Such initials shall not be more than 2 cm (0.78 in) in height. 	<ul style="list-style-type: none"> Players representing Member Boards who have won the ICC Test Play-off may display a symbol on the playing shirt for each of the occasions that this accomplishment has been achieved. No restrictions on position. Each symbol shall not exceed 1 sq cm in size. The name of the opposing touring team or the name of the country being toured as well as the year of such tour may be displayed on the chest of the playing shirt immediately below the National Logo provided such numbers and letters shall not exceed 1 cm (0.4 in) in height.

TEST MATCHES PLAYING TROUSERS

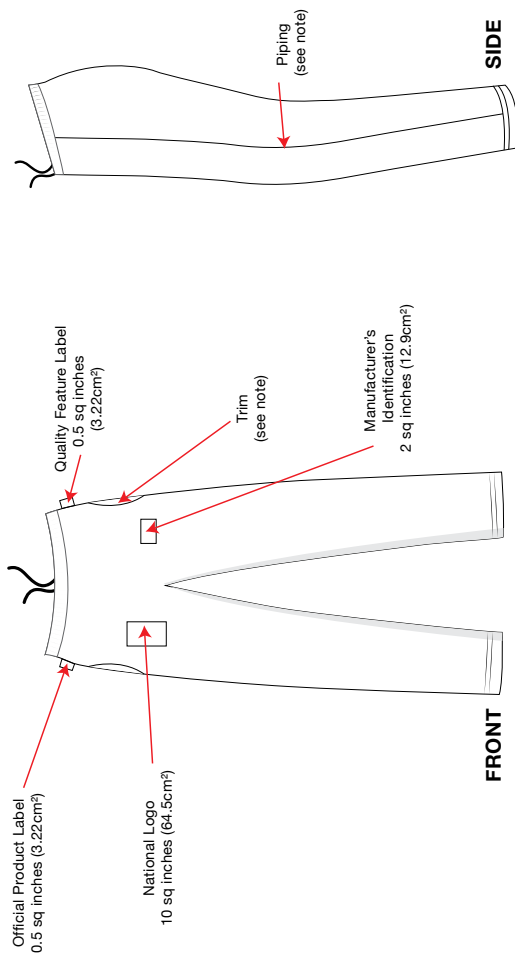

NOTE

COLOUR & DESIGN	NAME, NUMBER & INITIALS	OTHER MARKS & INSIGNIA
<ul style="list-style-type: none"> • Trousers shall be plain white/cream, save that coloured piping or trim shall be permitted subject to the following restrictions: <ul style="list-style-type: none"> • Piping is restricted to 0.5 cm (0.2 in) in width. • Piping is restricted to the edge of the pockets and the outside seam of the leg of the trousers. • Only one colour of piping/trim is permitted and shall be the same colour as the piping/trim, if any, on the playing shirt. • If coloured piping/trim is used, the colour and design of the trousers shall be uniform to all members of the same team. • The inside of the pocket may be of a plain colour other than white/cream. 	<ul style="list-style-type: none"> • None permitted. 	<ul style="list-style-type: none"> • None permitted.

TEST MATCHES PLAYING CAP AND SUN HAT

National Logo
10 sq inches (64.5cm²)

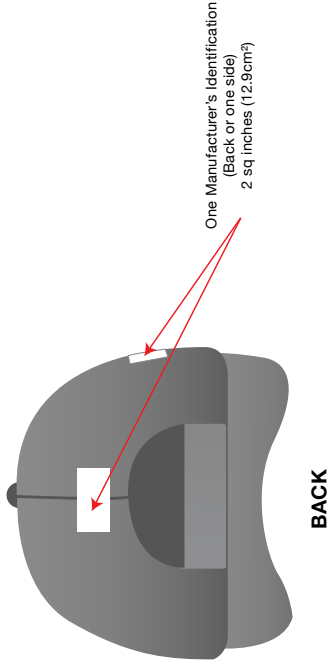
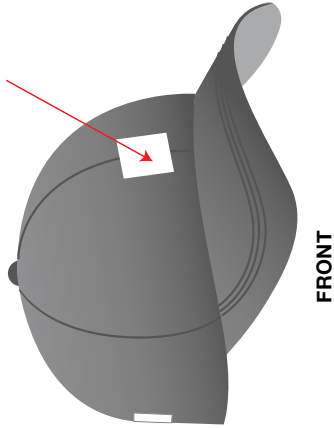

NOTE

COLOUR & DESIGN	NAME, NUMBER & INITIALS	OTHER MARKS & INSIGNIA
<ul style="list-style-type: none"> The colours and design of caps and sunhats shall be uniform to all members of the same team. 	<ul style="list-style-type: none"> One of the following numbers is permitted to be displayed on the caps and sunhats in a position immediately below the National Logo: <ul style="list-style-type: none"> Indicating a player's order of selection for his country, or Indicating the number of caps earned by a player for his country, or Indicating a player's landmark achievement (50, 100, 150 Tests etc.). Such numbers shall not be more than 2 cm (0.78 in) in height. A player's initials may be displayed on the back or side of the cap or sunhat. Such initials shall not be more than 2 cm (0.78 in) in height. 	<ul style="list-style-type: none"> None permitted.

ONE DAY INTERNATIONALS PLAYING SWEATER - LONG SLEEVED

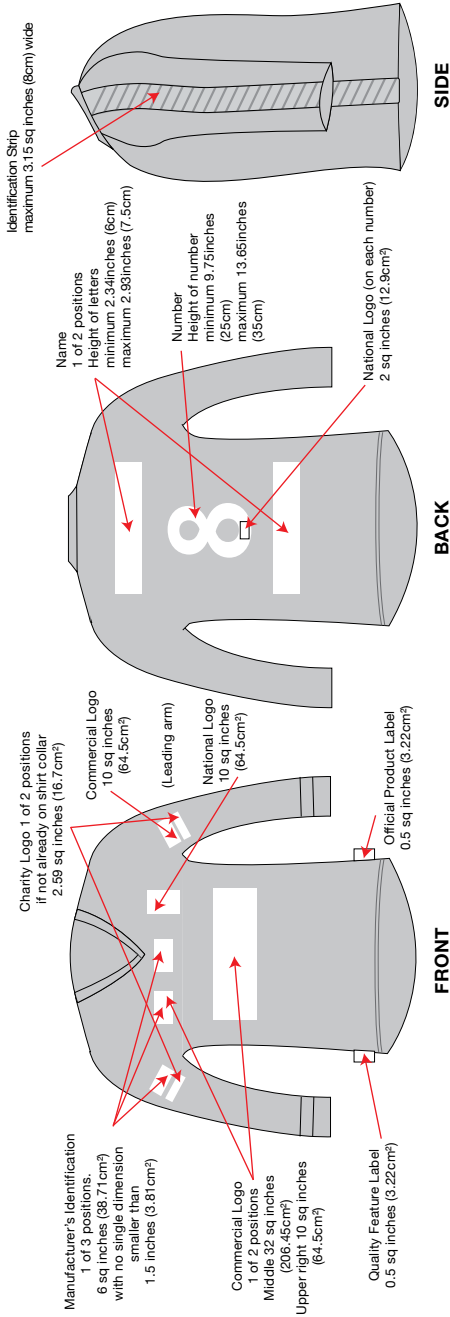

NOTE

COLOUR & DESIGN

- Each Member Board shall be entitled to choose the colours and design of its playing sweater subject to the following restrictions:
 - The sweaters shall be coloured other than white, cream or any light colour which is likely to make the sighting of a white ball difficult; the decision of the ICC Cricket Operations Manager being final.
 - The colours and design of the playing sweaters shall be uniform to all members of the same team.
 - Each Member Board shall be required to register the pantone colours of its playing clothing with the ICC prior to its use thereof.

NAME, NUMBER & INITIALS

- In the event of names and/or numbers of players being carried on the playing sweaters, they shall correctly reflect the identity of the player. The number on the sweaters shall be clearly legible and positioned in the centre back of the sweater.
 - The numbers shall be sewn on or fixed by heat transfer and not affixed by Velcro or any temporary means.
 - The names must be positioned above or below the number on the back of the sweater and the letters used must be clearly legible.
 - The names and numbers may not contain any advertising elements.
 - In addition, one of the following numbers is permitted to be displayed on the playing sweaters in a position immediately below the National Logo:
 - Indicating a player's order of selection for his country, or
 - Indicating the number of caps earned by a player for his country, or
 - Indicating a player's landmark achievement (50, 100, 150 ODIs etc.).
 - Such numbers shall not be more than 2 cm (0.78 in) in height.
 - A player's initials may be displayed on the chest or sleeve of the long sleeved sweater. Such initials shall not be more than 2 cm (0.78 in) in height.

OTHER MARKS & INSIGNIA

- Nothing contained herein shall prevent the National Logo, the name of the country and/or the national flag or elements contained therein from being incorporated as part of the design of the playing sweaters.
- Players representing Member Boards who have won the ICC Cricket World Cup may display a symbol on the playing sweater for each of the occasions that this accomplishment has been achieved. No restrictions on position. Each symbol shall not exceed 1 sq cm in size.
- The name of the opposing touring team or the name of the country being toured as well as the year of such tour may be displayed on the chest of the playing sweater immediately below the National Logo provided such numbers and letters shall not exceed 1 cm (0.4 in) in height.

ONE DAY INTERNATIONALS PLAYING SWEATER - SLEEVELESS

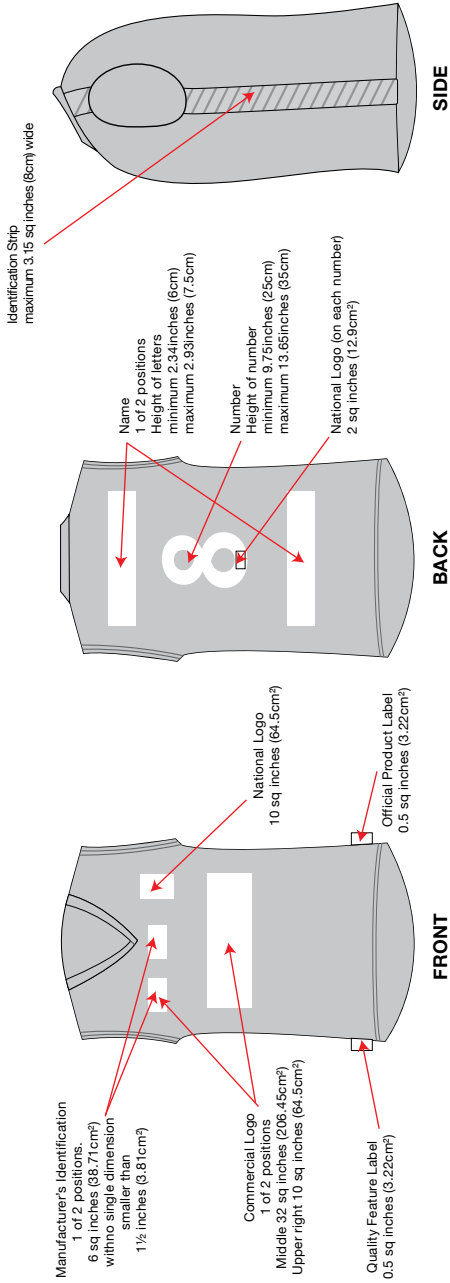

NOTE

COLOUR & DESIGN

- Each Member Board shall be entitled to choose the colours and design of its playing sweater subject to the following restrictions:
 - The sweaters shall be coloured other than white, cream or any light colour which is likely to make the sighting of a white ball difficult, the decision of the ICC Cricket Operations Manager being final.
 - The colours and design of the playing sweaters shall be uniform to all members of the same team.
 - Each Member Board shall be required to register the pantone colours of its playing clothing with the ICC prior to its use thereof.

NAME, NUMBER & INITIALS

- In the event of names and/or numbers of players being carried on the playing sweaters, they shall correctly reflect the identity of the player. The number on the sweaters shall be clearly legible, positioned in the centre back of the sweater.
 - The numbers shall be sewn on or fixed by heat transfer and not affixed by Velcro or any temporary means.
 - The names must be positioned above or below the number on the back of the sweater and the letters used must be clearly legible.
 - The names and numbers may not contain any advertising elements.
 - In addition, one of the following numbers is permitted to be displayed on the playing sweaters in a position immediately below the National Logo:
 - Indicating a player's order of selection for his country, or
 - Indicating the number of caps earned by a player for his country, or
 - Indicating a player's landmark achievement (50, 100, 150 ODIs etc.).
 - Such numbers shall not be more than 2 cm (0.78 in) in height.
 - A player's initials may be displayed on the chest of the sleeveless sweater. Such initials shall not be more than 2 cm (0.78 in) in height.

OTHER MARKS & INSIGNIA

- Nothing contained herein shall prevent the National Logo, the name of the country and/or the national flag or elements contained therein from being incorporated as part of the design of the playing sweaters.
- Players representing Member Boards who have won the ICC Cricket World Cup may display a symbol on the chest of the playing sweater for each of the occasions that this accomplishment has been achieved. No restrictions on position. Each symbol shall not exceed 1 sq cm in size.
- The name of the opposing touring team or the name of the country being toured as well as the year of such tour may be displayed on the chest of the playing sweater immediately below the National Logo provided such numbers and letters shall not exceed 1 cm (0.4 in) in height.

ONE DAY INTERNATIONALS PLAYING SHIRT

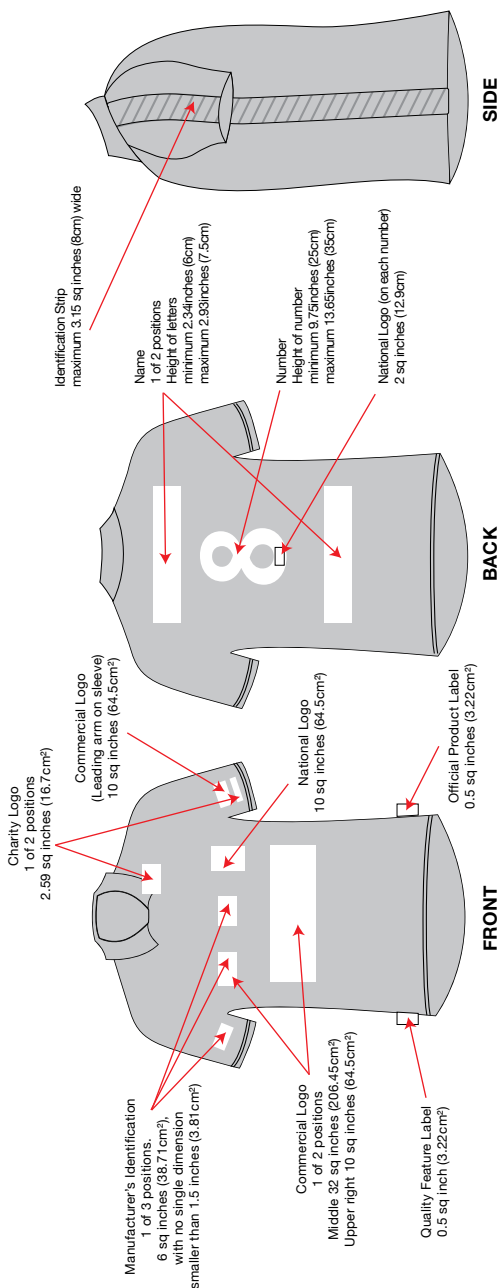

NOTE

COLOUR & DESIGN

- Each Member Board shall be entitled to choose the colours and design of its playing shirt subject to the following restrictions:
- The playing shirts shall be coloured other than white, cream or any light colour which is likely to make the sighting of a white ball difficult, the decision of the ICC Cricket Operations Manager being final.
- The colours and design of the playing shirts shall be uniform to all members of the same team.
- Playing shirt sleeves may be cut to any length, as long as both sleeves are evenly trimmed and the edges are sewn and hemmed.
- Each Member Board shall be required to register the pantone colours of its playing clothing with the ICC prior to its use thereof.

NAME, NUMBER & INITIALS

- In the event of names and/or numbers of players being carried on the playing shirts, they shall correctly reflect the identity of the player. The number on the shirts shall be clearly legible, positioned in the centre back of the shirt.
- The numbers shall be sewn on or fixed by heat transfer and not affixed by Velcro or any temporary means.
- The names must be positioned above or below the number on the back of the shirt and the letters used must be clearly legible.
- The names and numbers may not contain any advertising elements.
- In addition, one of the following numbers is permitted to be displayed on the playing shirts in a position immediately below the National Logo:
 - Indicating a player's order of selection for his country, or
 - Indicating the number of caps earned by a player for his country, or
 - Indicating a player's landmark achievement (50, 100, 150 ODIs etc.).
- Such numbers shall not be more than 2 cm (0.78 in) in height.
- A player's initials may be displayed on the chest or sleeve of the playing shirt. Such initials shall not be more than 2 cm (0.78 in) in height.

OTHER MARKS & INSIGNIA

- Nothing contained herein shall prevent the National Logo, the name of the country and/or the national flag or elements contained therein from being incorporated as part of the design of the playing shirts.
- Players representing Member Boards who have won the ICC Cricket World Cup may display a symbol on the chest of the playing shirt for each of the occasions that this accomplishment has been achieved. No restrictions on position. Each symbol shall not exceed 1 sq cm in size.
- The name of the opposing touring team or the name of the country being toured as well as the year of such tour may be displayed on the chest of the playing shirt immediately below the National Logo provided such numbers and letters shall not exceed 1 cm (0.4 in) in height.

ONE DAY INTERNATIONALS PLAYING TROUSERS

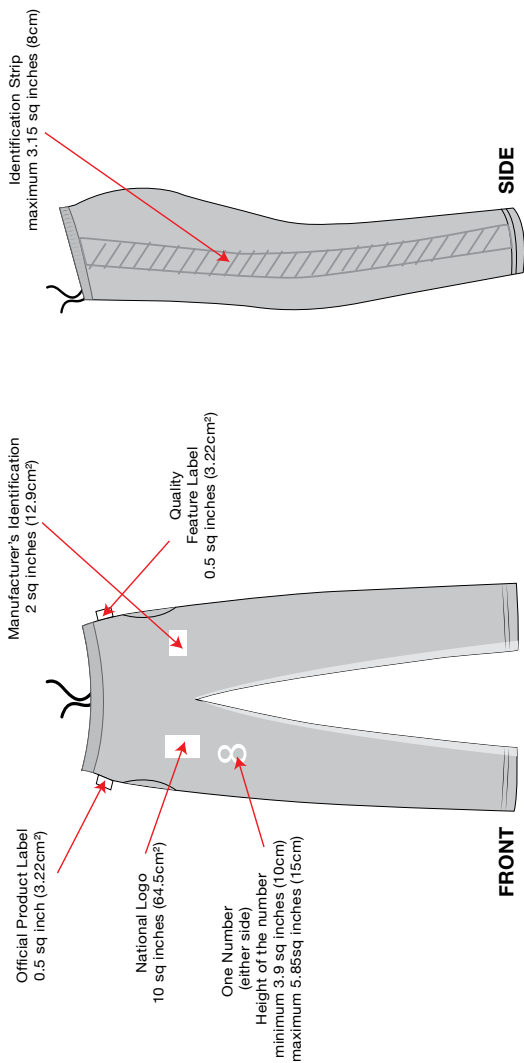

NOTE

COLOUR & DESIGN

- Each Member Board shall be entitled to choose the colours and design of its playing trousers subject to the following restrictions:
- The playing trousers shall be coloured other than white, cream or any light colour which is likely to make the sighting of a white ball difficult, the decision of the ICC Cricket Operations Manager being final.
- The colours and design of the playing trousers shall be uniform to all members of the same team.
- Each Member Board shall be required to register the pantone colours of its playing clothing with the ICC prior to its use thereof.

NAME, NUMBER & INITIALS

- In the event of numbers being carried on the trousers, they shall be clearly legible and positioned on the front of either leg above the knee.
- The numbers shall be sewn on or fixed by heat transfer and not affixed by Velcro or any temporary means.

OTHER MARKS & INSIGNIA

- Nothing contained herein shall prevent the National Logo, the name of the country and/or the national flag or elements contained therein from being incorporated as part of the design of the playing trousers.

ONE DAY INTERNATIONALS PLAYING CAP AND SUN HAT

National Logo
10 sq inches (64.5cm²)

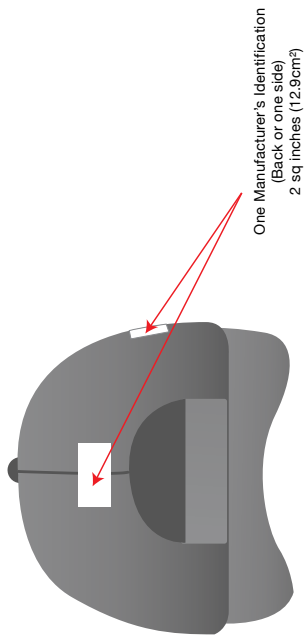
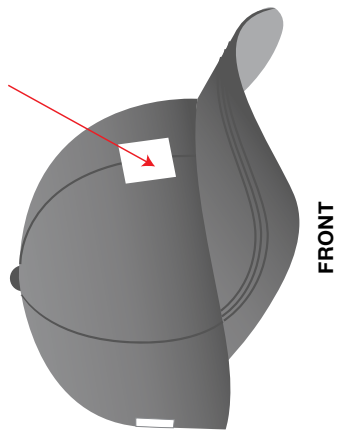

NOTE

COLOUR & DESIGN	NAME, NUMBER & INITIALS	OTHER MARKS & INSIGNIA
<ul style="list-style-type: none"> The colours and design of caps and sunhats shall be uniform to all members of the same team. 	<ul style="list-style-type: none"> One of the following numbers is permitted to be displayed on the caps and sunhats in a position immediately below the National Logo or on one side: <ul style="list-style-type: none"> Indicating a player's order of selection for his country, or Indicating the number of caps earned by a player for his country, or Indicating a player's landmark achievement (50, 100, 150 ODIs etc.). Such numbers shall not be more than 2 cm (0.78 in) in height. A player's initials may be displayed on the back or one side of the cap or sunhat. Such initials shall not be more than 2 cm (0.78 in) in height. 	<ul style="list-style-type: none"> None permitted.

T20 INTERNATIONALS PLAYING SWEATER - LONG SLEEVED

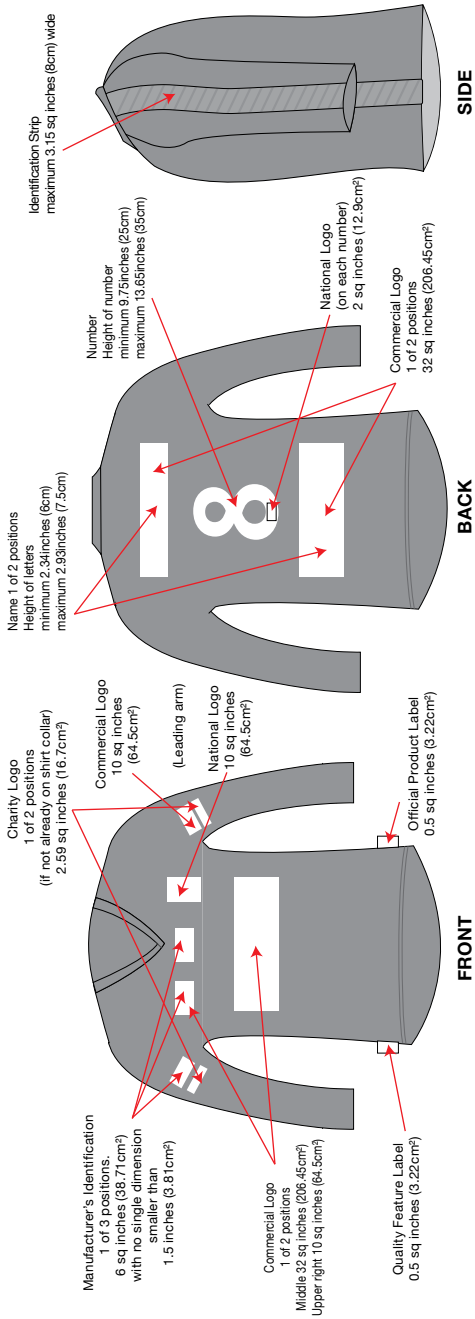

NOTE

COLOUR & DESIGN

- Each Member Board shall be entitled to choose the colours and design of its playing sweater subject to the following restrictions:
- The sweaters shall be coloured other than white, cream or any light colour which is likely to make the sighting of a white ball difficult, the decision of the ICC Cricket Operations Manager being final.
- The colours and design of the playing sweaters shall be uniform to all members of the same team.
- Each Member Board shall be required to register the pantone colours of its playing clothing with the ICC prior to its use thereof.

NAME, NUMBER & INITIALS

- In the event of names and/or numbers of players being carried on the playing sweaters, they shall correctly reflect the identity of the player. The number on the sweaters shall be clearly legible, positioned in the centre back of the sweater.
- The numbers shall be sewn on or fixed by heat transfer and not affixed by Velcro or any temporary means.
- The names must be positioned above or below the number on the back of the sweater and the letters used must be clearly legible.
- The names and numbers may not contain any advertising elements.
- In addition, one of the following numbers is permitted to be displayed on the playing sweaters in a position immediately below the National Logo:
 - Indicating a player's order of selection for his country, or
 - Indicating the number of caps earned by a player for his country, or
 - Indicating a player's landmark achievement (50, 100, 150 T20Is etc.).
- Such numbers shall not be more than 2 cm (0.78 in) in height.
- A player's initials may be displayed on the chest or sleeve of the long sleeved sweater. Such initials shall not be more than 2 cm (0.78 in) in height.

OTHER MARKS & INSIGNIA

- Nothing contained herein shall prevent the National Logo, the name of the country and/or the national flag or elements contained therein from being incorporated as part of the design of the playing sweaters.
- Players representing Member Boards who have won the ICC World Twenty20 may display a symbol on the chest or sleeve of the long sleeved playing sweater for each of the occasions that this accomplishment has been achieved. No restrictions on position. Each symbol shall not exceed 1 sq cm in size.
- The name of the opposing touring team or the name of the country being toured as well as the year of such tour may be displayed on the chest of the playing sweater immediately below the National Logo provided such numbers and letters shall not exceed 1 cm (0.4 in) in height.

T20 INTERNATIONALS PLAYING SWEATER - SLEEVELESS

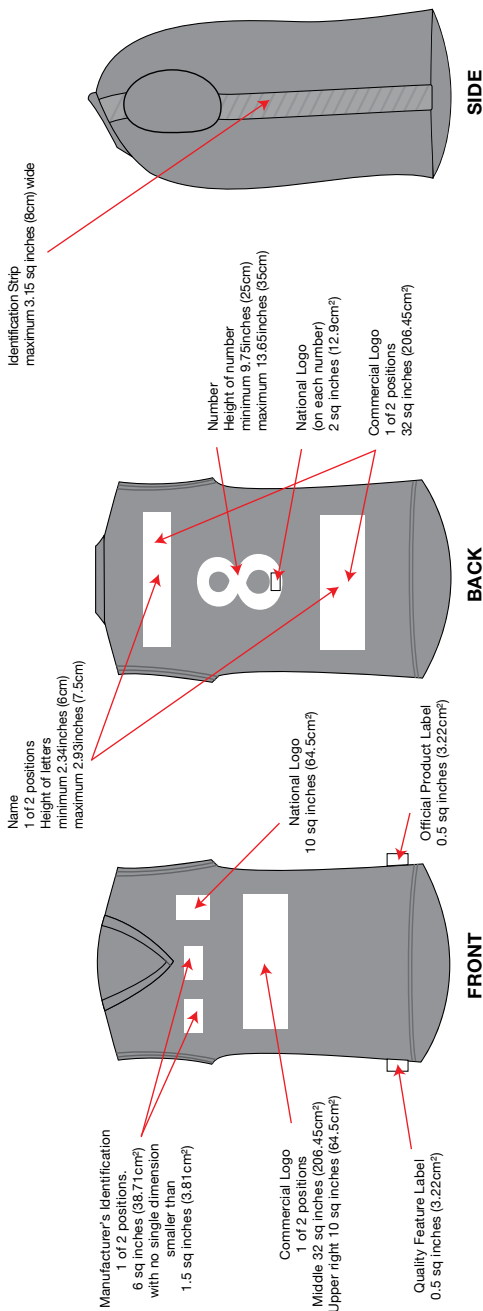

NOTE

COLOUR & DESIGN

- Each Member Board shall be entitled to choose the colours and design of its playing sweater subject to the following restrictions:
 - The sweaters shall be coloured other than white, cream or any light colour which is likely to make the sighting of a white ball difficult; the decision of the ICC Cricket Operations Manager being final.
 - The colours and design of the playing sweaters shall be uniform to all members of the same team.
 - Each Member Board shall be required to register the pantone colours of its playing clothing with the ICC prior to its use thereof.

NAME, NUMBER & INITIALS

- In the event of names and/or numbers of players being carried on the playing sweaters, they shall correctly reflect the identity of the player. The number on the sweaters shall be clearly legible, positioned in the centre back of the sweater.
- The numbers shall be sewn on or fixed by heat transfer and not affixed by Velcro or any temporary means.
- The names must be positioned above or below the number on the back of the sweater and the letters used must be clearly legible.
- The names and numbers may not contain any advertising elements.
- In addition, one of the following numbers is permitted to be displayed on the playing sweaters in a position immediately below the National Logo:
 - Indicating a player's order of selection for his country, or
 - Indicating the number of caps earned by a player for his country, or
 - Indicating a player's landmark achievement (50, 100, 150 Tests etc.).
- Such numbers shall not be more than 2 cm (0.78 in) in height.
- A player's initials may be displayed on the chest of the sleeveless sweater. Such initials shall not be more than 2 cm (0.78 in) in height.

OTHER MARKS & INSIGNIA

- Nothing contained herein shall prevent the National Logo, the name of the country and/or the national flag or elements contained therein from being incorporated as part of the design of the playing sweaters.
- Players representing Member Boards who have won the ICC World Twenty20 may display a symbol on the chest of the playing sweater for each of the occasions that this accomplishment has been achieved. No restrictions on position. Each symbol shall not exceed 1 sq cm in size.
- The name of the opposing touring team or the name of the country being toured as well as the year of such tour may be displayed on the playing sweaters immediately below the National Logo provided such numbers and letters shall not exceed 1 cm (0.4 in) in height.

T20 INTERNATIONALS PLAYING SHIRT

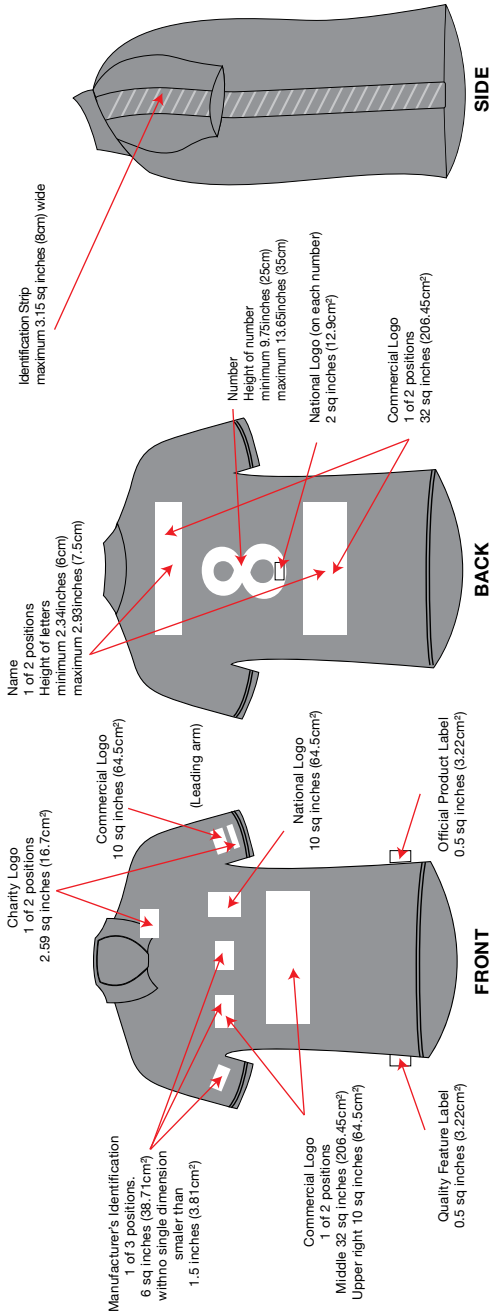

NOTE

COLOUR & DESIGN

- Each Member Board shall be entitled to choose the colours and design of its playing shirt subject to the following restrictions:
 - The playing shirts shall be coloured other than white, cream or any light colour which is likely to make the sighting of a white ball difficult; the decision of the ICC Cricket Operations Manager being final.
 - The colours and design of the playing shirts shall be uniform to all members of the same team. Playing shirt sleeves may be cut to any length, as long as both sleeves are evenly trimmed and the edges are sewn and hemmed.
 - Each Member Board shall be required to register the pantone colours of its playing clothing with the ICC prior to its use thereof.

NAME, NUMBER & INITIALS

- In the event of names and/or numbers of players being carried on the shirts, they shall correctly reflect the identity of the player. The number on the shirts shall be clearly legible, positioned in the centre back of the shirt.
- The numbers shall be sewn on or fixed by heat transfer and not affixed by Velcro or any temporary means.
- The names must be positioned above or below the number on the back of the shirt and the letters used must be clearly legible.
- The names and numbers may not contain any advertising elements.
- In addition, one of the following numbers is permitted to be displayed on the playing shirts in a position immediately below the National Logo:
 - Indicating a player's order of selection for his country, or for his country, or
 - Indicating a player's landmark achievement (50, 100, 150 Tests etc.).
- Such numbers shall not be more than 2 cm (0.78 in) in height.
- A player's initials may be displayed on the chest or sleeve of the playing shirt. Such initials shall not be more than 2 cm (0.78 in) in height.

OTHER MARKS & INSIGNIA

- Nothing contained herein shall prevent the National Logo, the name of the country and/or the national flag or elements contained therein from being incorporated as part of the design of the playing shirt.
- Players representing Member Boards who have won the ICC World Twenty20 may display a symbol on the chest of the playing shirt for each of the occasions that this accomplishment has been achieved. No restrictions on position. Each symbol shall not exceed 1.5 cm in size.
- The name of the opposing touring team or the name of the country being toured as well as the year of such tour may be displayed on the chest of the playing shirt immediately below the National Logo provided such numbers and letters shall not exceed 1 cm (0.4 in) in height.

T20 INTERNATIONALS PLAYING TROUSERS

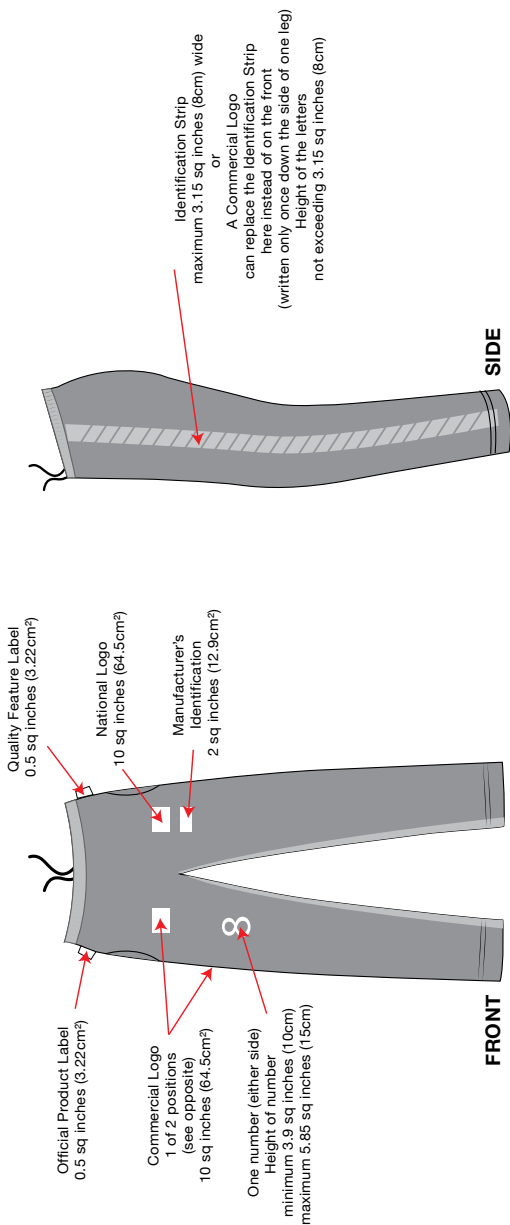

NOTE

COLOUR & DESIGN

- Each Member Board shall be entitled to choose the colours and design of its playing trousers subject to the following restrictions:
- The playing trousers shall be coloured other than white, cream or any light colour which is likely to make the sighting of a white ball difficult, the decision of the ICC Cricket Operations Manager being final.
- The colours and design of the playing trousers shall be uniform to all members of the same team.
- Each Member Board shall be required to register the pantone colours of its playing clothing with the ICC prior to its use thereof.

NAME, NUMBER & INITIALS

- In the event of numbers being carried on the trousers, they shall be clearly legible and positioned on the front of either leg above the knee.
- The numbers shall be sewn on or fixed by heat transfer and not affixed by Velcro or any temporary means.

OTHER MARKS & INSIGNIA

- Nothing contained herein shall prevent the National Logo, the name of the country and/or the national flag or elements contained therein from being incorporated as part of the design of the playing trousers.

T20 INTERNATIONALS PLAYING CAP AND SUN HAT

National Logo
10 sq inches (64.5cm²)

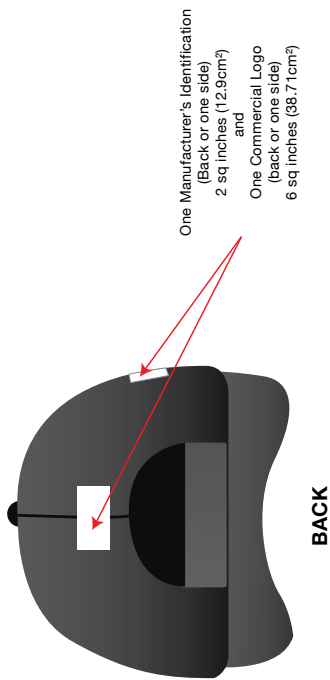
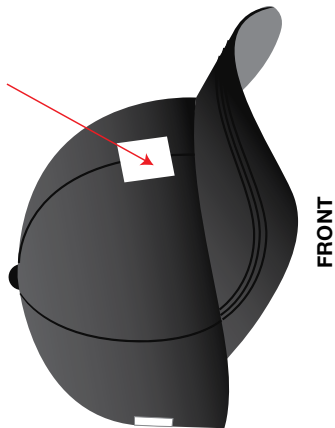

NOTE

COLOUR & DESIGN	NAME, NUMBER & INITIALS	OTHER MARKS & INSIGNIA
<ul style="list-style-type: none"> The colours and design of caps and sunhats shall be uniform to all members of the same team. 	<ul style="list-style-type: none"> One of the following numbers is permitted to be displayed on the caps and sunhats in a position immediately below the National Logo or on one side: <ul style="list-style-type: none"> Indicating a player's order of selection for his country, or Indicating the number of caps earned by a player for his country, or Indicating a player's landmark achievement (50, 100, 150 Tzolis etc.). Such numbers shall not be more than 2 cm (0.78 in) in height. A player's initials may be displayed on the back or side of the cap or sunhat. Such initials shall not be more than 2 cm (0.78 in) in height. 	<ul style="list-style-type: none"> Nothing contained herein shall prevent the National Logo, the name of the country and/or the national flag or elements contained therein from being incorporated as part of the design of the playing cap and sunhat.

OTHER CLOTHING

T-SHIRTS (worn under playing shirt)

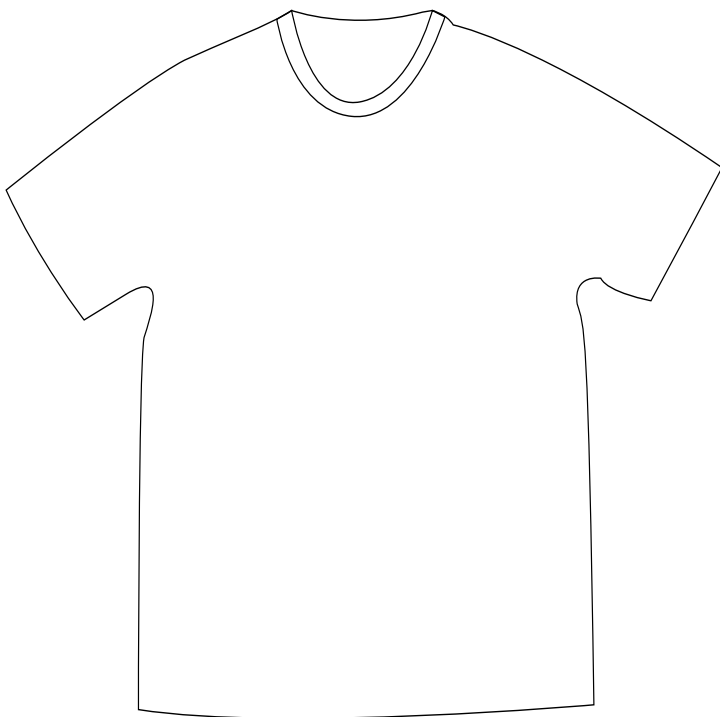

NOTE

COLOUR & DESIGN	LOGOS
<ul style="list-style-type: none">• Test Matches - Plain white.• ODIs / T20Is - Plain white or the same colour as the base colour of the playing shirt.	<ul style="list-style-type: none">• No visible logos permitted.

OTHER CLOTHING

SKINS (worn under playing shirt)



NOTE

COLOUR & DESIGN	LOGOS
<ul style="list-style-type: none">• Test Matches - Plain white.• ODIs / Tzols - Of one colour and uniform for all members of the same team; and The same colour as any colour of the playing shirt or trousers. <p>White skins may be worn provided they do not protrude from the shirt sleeves.</p>	<ul style="list-style-type: none">• No visible logos permitted.

OTHER CLOTHING

SOCKS

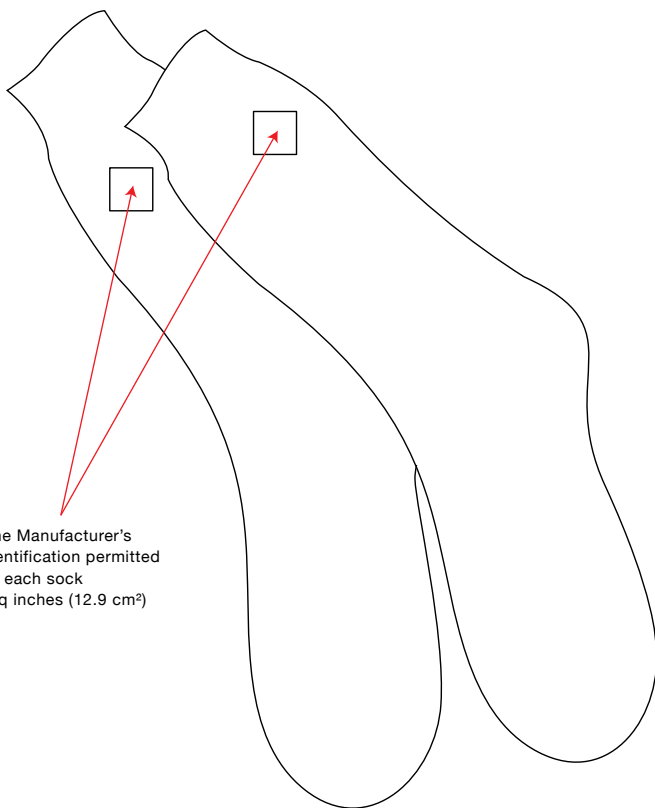

One Manufacturer's Identification permitted on each sock
2sq inches (12.9 cm²)

NOTE

COLOUR & DESIGN	LOGOS
<ul style="list-style-type: none">• Test Matches - White, cream or light grey.• ODIs / T2ols - White, cream or light grey or the same colour as the base colour of the playing trousers.	<ul style="list-style-type: none">• Apart from Manufacturer's Identification, no visible logos are permitted

OTHER CLOTHING

TURBANS, BANDANAS AND HIJABS

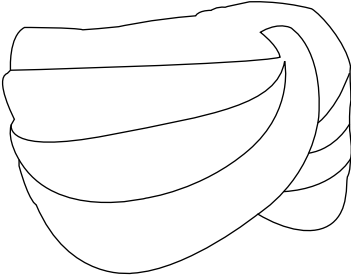

A bandana may only be worn as a cover to a turban or beneath a helmet.

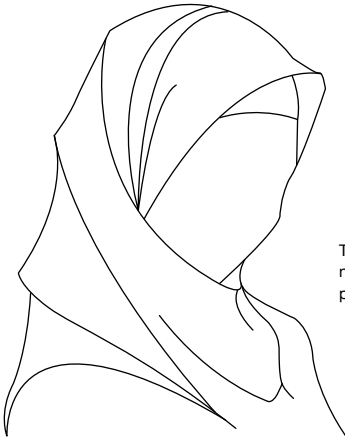
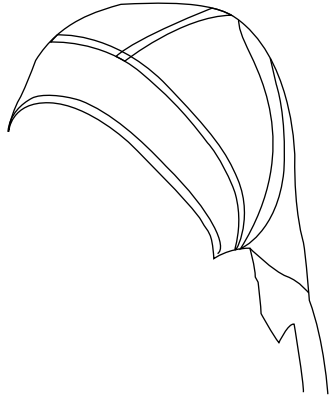

The Hijab shall not cover names, numbers or logos permitted on the playing uniform.

NOTE

COLOUR & DESIGN	LOGOS
<ul style="list-style-type: none">• Test Matches - plain black or plain white.• ODIs / Tzols - plain black or plain white or the same plain base colour as the team cap.	<ul style="list-style-type: none">• No visible logos permitted.

OTHER CLOTHING HEADBANDS AND WRISTBANDS

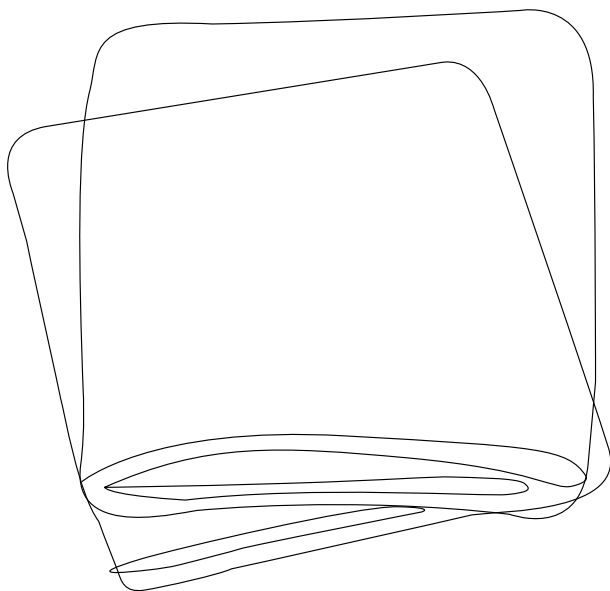

NOTE

COLOUR & DESIGN	LOGOS
<ul style="list-style-type: none">• Test Matches - plain white.• ODIs / T20Is - plain coloured other than white or any light colour which is likely to make the sighting of the white ball difficult, the decision of the ICC Match Referee being final.	<ul style="list-style-type: none">• No visible logos permitted.

CRICKET EQUIPMENT

CRICKET BAT

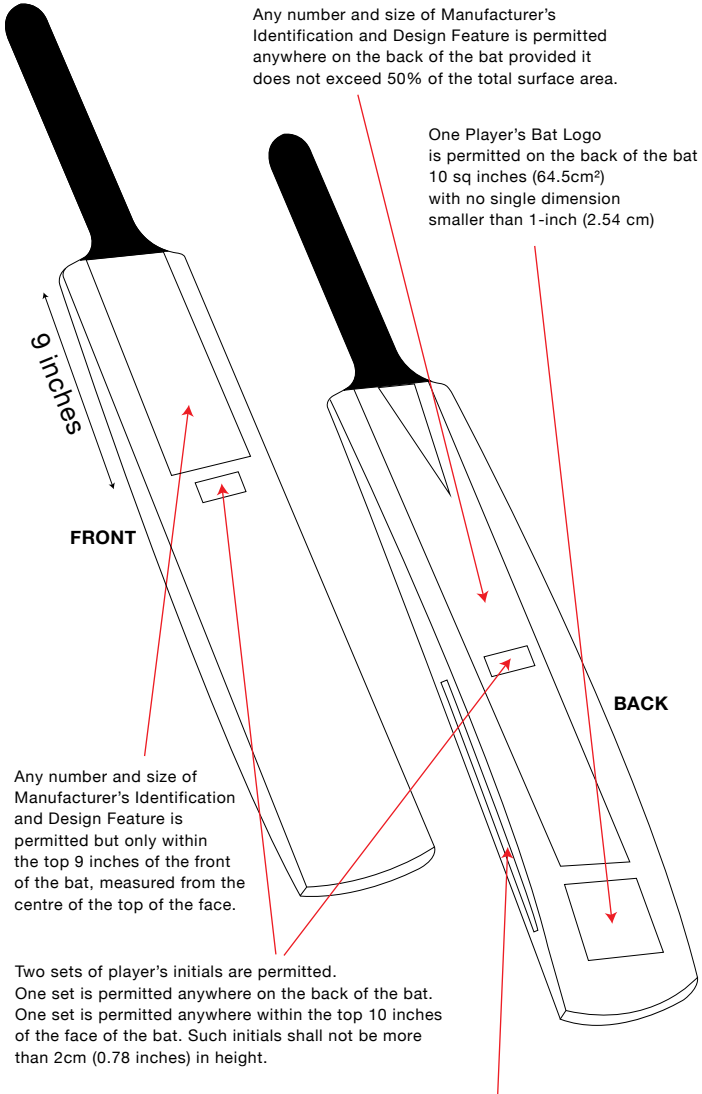

Any number and size of Manufacturer's Identification and Design Feature is permitted anywhere on the back of the bat provided it does not exceed 50% of the total surface area.

One Player's Bat Logo is permitted on the back of the bat 10 sq inches (64.5cm²) with no single dimension smaller than 1-inch (2.54 cm)

Any number and size of Manufacturer's Identification and Design Feature is permitted but only within the top 9 inches of the front of the bat, measured from the centre of the top of the face.

Two sets of player's initials are permitted.
One set is permitted anywhere on the back of the bat.
One set is permitted anywhere within the top 10 inches of the face of the bat. Such initials shall not be more than 2cm (0.78 inches) in height.

One Manufacturer's Identification and/or Design Feature permitted on the edge of the bat not exceeding 50% of the edge of the bat.

CRICKET EQUIPMENT

WICKET KEEPER GLOVES

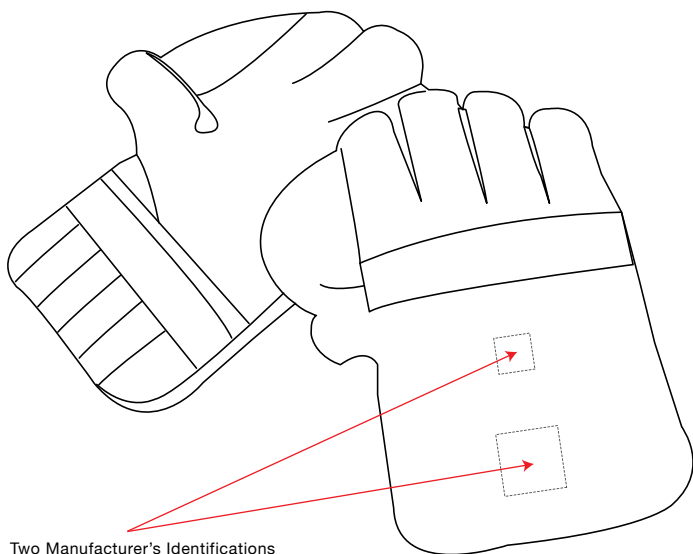

Two Manufacturer's Identifications
on the back of the each glove.
1 x 6sq inches (38.71cm²)
1 x 2 sq inches (12.9cm²)

NOTE

COLOUR & DESIGN	LOGOS
<ul style="list-style-type: none">Any visible stitching, ventilation, stencil effect or other design aspect of the glove which is in the shape or form of the Manufacturer's Identification will be considered as the Manufacturer's Identification permitted in the diagram.	<ul style="list-style-type: none">No visible logos permitted other than those identified in the diagram.

CRICKET EQUIPMENT BATTING GLOVES

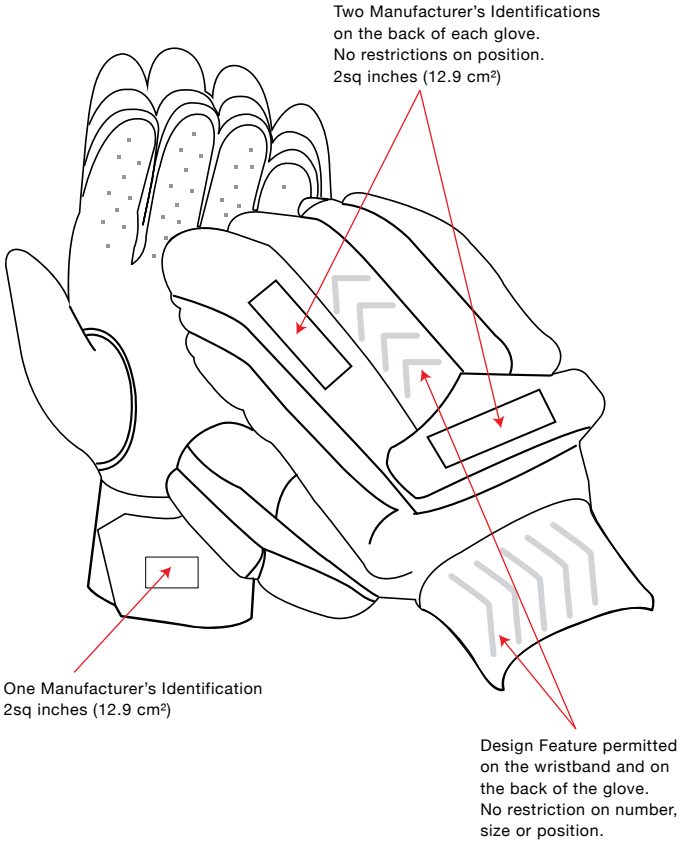

NOTE

COLOUR & DESIGN	LOGOS
<ul style="list-style-type: none"> • Test Matches – more than 50% of the protective area of the glove must be white. • ODIs and T20s – more than 50% of the protective area of the glove must be white, or the same colour as the base colour of the relevant team's playing shirt. 	<ul style="list-style-type: none"> • No visible logos permitted other than those identified in the diagram.

CRICKET EQUIPMENT HELMET

National Logo
10 sq inches (64.5cm²)

FRONT

Manufacturer's Identification
on the top of each earpiece
or the top of both sides of the grid
2 sq inches (12.9cm²)

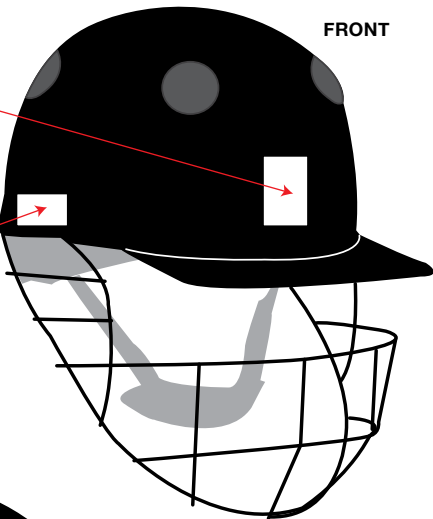

BACK

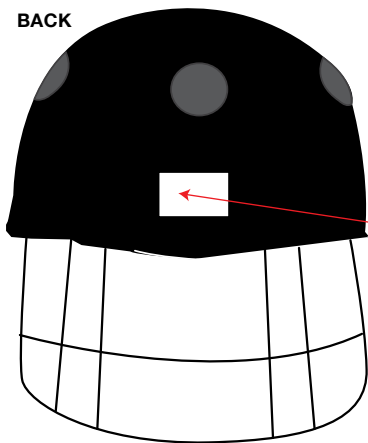

Manufacturer's Identification
on the back of the helmet
2 sq inches (12.9cm²)

NOTE

COLOUR & DESIGN	LOGOS
<p>In all formats of the game:</p> <ul style="list-style-type: none">• Helmets shall be one plain colour.• The colour of the helmet shall be uniform to all members of the same team.	<ul style="list-style-type: none">• No visible logos permitted other than those identified in the diagram.

CRICKET EQUIPMENT

WICKET KEEPER PADS

One Manufacturer's Identification in 1 of 2 positions on the front of pad
4 sq inches (25.81cm²)

One Manufacturer's Identification inside top of pad
no size restriction

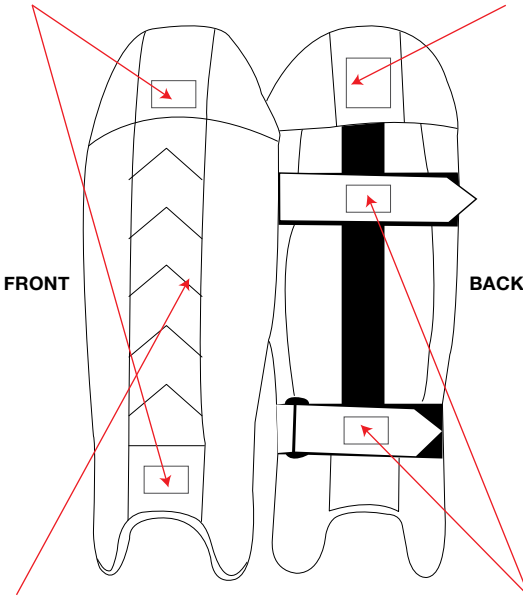

Design Feature is permitted on the front of the pad.
No restriction on the number, size or position.

One Manufacturer's Identification on one of the pad straps
1 of 2 positions
4 sq inches (25.81 cm²)

NOTE

TEST MATCHES	ODIs & T20Is
<ul style="list-style-type: none"> • Pads shall be plain white save that the straps may be in the house colours of the Manufacturer. • Coloured piping shall be permitted below the ankle strap of the pad only. • Design Feature shall be white only. 	<ul style="list-style-type: none"> • Pads shall be plain coloured other than white or any light colour which is likely to make the sighting of the white ball difficult, the decision of the ICC Match Referee being final. The straps may be in the house colours of the Manufacturer. • Design Feature shall be the same colour as the colour of the pad. • The colour of the pads must be properly maintained. Discoloured or faded pads will not be permitted.

CRICKET EQUIPMENT

BATTING PADS

Design Feature is permitted on the front of the pad. No restriction on the number, size or position same colour as the pad. (see note)

One Manufacturer's Identification inside top of pad no size restriction

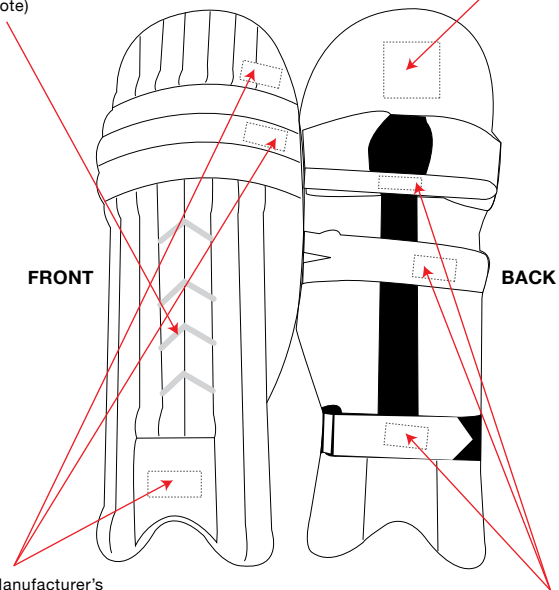

One Manufacturer's Identification in 1 of 3 positions on the front of pad 4 sq inches (25.81 cm²)

One Manufacturer's Identification 1 of 3 positions on one of the pad straps 4 sq inches (25.81 cm²)

NOTE

TEST MATCHES	ODIs & T20Is
<ul style="list-style-type: none"> • Pads shall be plain white save that the straps may be in the house colours of the manufacturer. • Coloured piping shall be permitted below the ankle strap of the pad only. • Design features shall be white only. 	<ul style="list-style-type: none"> • Pads shall be plain coloured other than white or any light colour which is likely to make the sighting of the white ball difficult, the decision of the ICC Match Referee being final. The straps may be in the house colours of the Manufacturer. • Design features shall be the same colour of the pad. • The colour of the pads shall be uniform to all members of the same team. • The colour of the pads must be properly maintained. Discoloured or faded pads will not be permitted.

CRICKET EQUIPMENT

SHOES AND BOOTS

Two Manufacturer's Identifications in 2 positions, one on the tongue and one on any other position on the shoe / boot. Neither to exceed 2 sq inches (12.9cm²)



One Manufacturer's Identification may be displayed on the sole. No size restriction

NOTE

TEST MATCHES	ODIs & T20Is
<ul style="list-style-type: none">• The upper, tongue and laces of the shoes/ boots shall be predominantly white.• Stripes and Design Features shall be permitted provided that they shall be in a maximum of two colours (other than white).	<ul style="list-style-type: none">• The upper and tongue of the shoes/boots shall be predominantly white or may be the same colours as the playing kit.• Laces shall be predominantly white or any other colours.• Stripes and Design Features shall be permitted provided that they shall be in a maximum of two colours.

CRICKET EQUIPMENT

SUN GLASSES

One Manufacturers Identification either on the left side or the right side of the frame, not exceeding 0.5sq inches (3.22cm²)

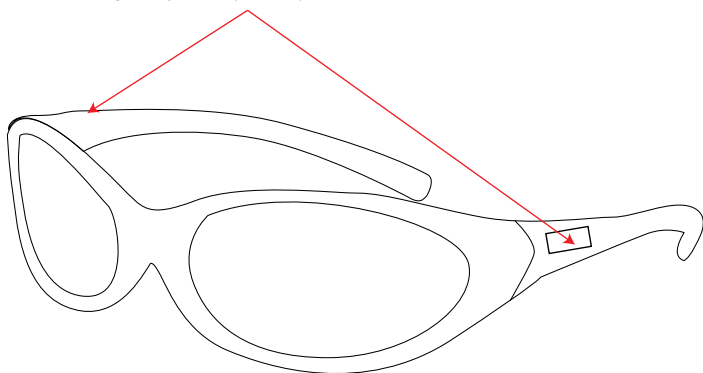

NOTE

COLOUR & DESIGN	LOGOS
<ul style="list-style-type: none">No restrictions on colour save that sunglasses strap / band must be of a single colour.	<ul style="list-style-type: none">No visible logos permitted other than those identified in the diagram.

CRICKET EQUIPMENT

ARM GUARDS

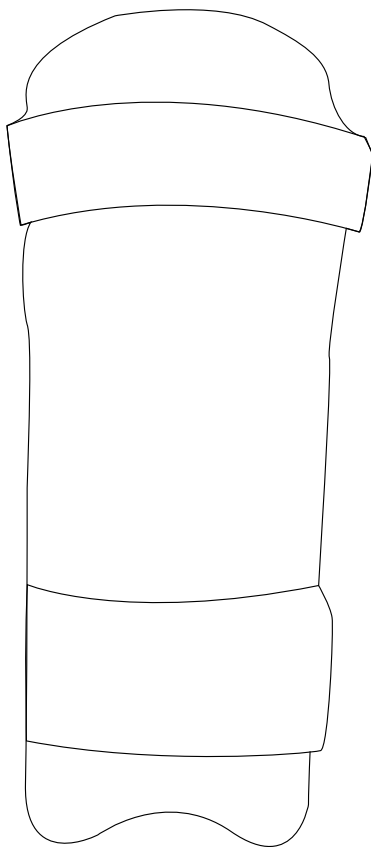

NOTE

COLOUR & DESIGN	LOGOS
<ul style="list-style-type: none">• Test Matches - Plain white save that the straps may be in the house colours of the Manufacturer.• ODIs / T20Is - Plain white or the same colour as the base colour of the Playing shirt. Straps may be in the house colours of the Manufacturer.	<ul style="list-style-type: none">• No visible logos.

CRICKET EQUIPMENT

FACE PROTECTORS

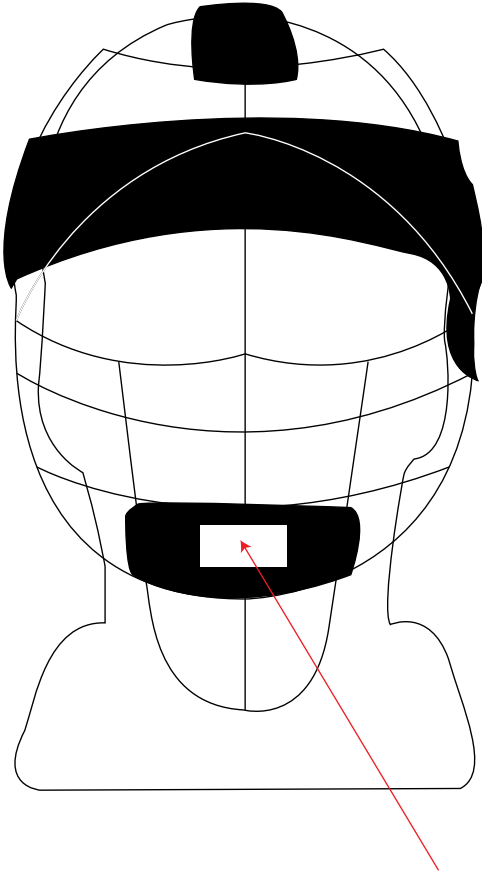

One Manufacturer's Identification is permitted. No restrictions on position. 2sq inches (12.9 cm²)

NOTE

COLOUR & DESIGN	LOGOS
<ul style="list-style-type: none">The face protector shall be one plain colour.	<ul style="list-style-type: none">No visible logos permitted other than those identified in the diagram.

CRICKET EQUIPMENT

STUMPS

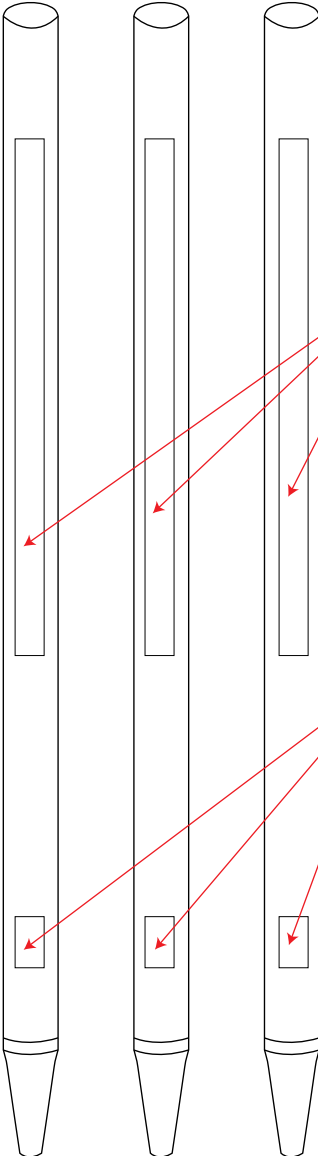

Test Matches: No regulation covering the colour of the stumps.

ODI's & T20's: No regulation covering the colour of the stumps save that the bails shall be of a distinguishing colour to that of the stumps.

Logos: The Event Logo and / or the Logo of the series or the sponsors may be displayed on each of the stumps. No size restriction. National Logos are not permitted on the stumps

Two Manufacturer's Identifications are permitted on each stump-one on the front and one on the back not exceeding 2sq inches (12.9 cm²)

CRICKET EQUIPMENT

THIGH PADS, SHIN PADS AND OTHER EQUIPMENT

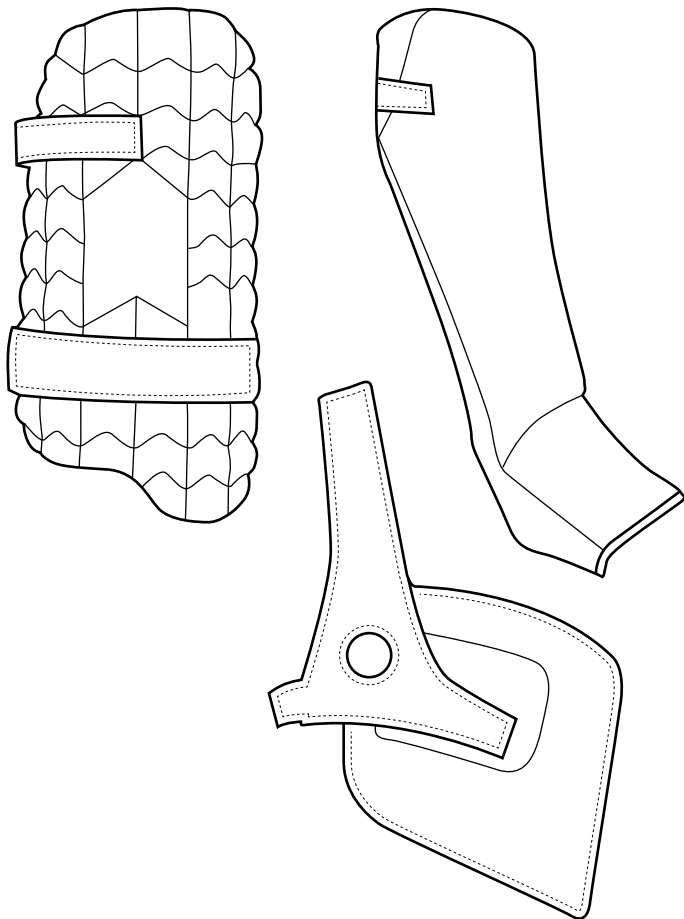

NOTE

COLOUR & DESIGN

- No restriction on colours save that these items must be worn under playing clothing and shall not be visible.

LOGOS

- No visible logos shall be permitted.

OTHER ICC REGULATIONS

OTHER ICC REGULATIONS

The following rules, agreements, regulations and documents are available on the ICC website (www.icc-cricket.com) or on request from enquiry@icc-cricket.com.

- ICC Anti-Racism Policy for International Cricket
- ICC Anti-Racism Policy for International Cricket – Implementation Guidelines for Members
- Code of Ethics
- Duckworth Lewis Method
- Full Membership Criteria
- ICC Affiliate Membership Criteria
- ICC Associate Membership Criteria
- ICC Code of Conduct for Umpires
- ICC Gender Recognition Policy
- ICC Memorandum and Articles
- Pepsi World Cricket League Playing Conditions
- Pepsi World Cricket League Championship Playing Conditions
- Pitch and Outfield Monitoring Process
- Player Eligibility Regulations
- Players' and Match Officials' Areas – Minimum Standards
- Regulation – Member Associations with Betting Companies
- Regulations for Approved/Disapproved Cricket and Domestic Cricket Events
 - a) ICC Classification of official cricket
 - b) Regulations for Approved/Disapproved Cricket and Domestic Cricket Events
 - c) Questions and Answers on Regulations for Approved/Disapproved Cricket and Domestic Cricket Events.
- Standard ICC Intercontinental Cup Playing Conditions
- Terms of Reference for the Code of Conduct Commission
- Terms of Reference of the Anti-Corruption and Security Unit
- Terms of Reference of the Disputes Resolution Committee
- Terms of Reference ICC Disciplinary Process
- Terms of Reference – Associate Members' Meetings
- Terms of Reference – Audit Committee
- Terms of Reference – Women's Committee

- Terms of Reference – HR and Remuneration Committee
- Terms of Reference – Finance and Commercial Affairs Committee
- Terms of Reference – Development Committee
- Terms of Reference – Chief Executive’s Committee
- Terms of Reference – Cricket Committee
- Terms of Reference – Medical Committee
- Terms of Reference – Associates and Affiliates Committee
- Women’s Test Match Playing Conditions



International Cricket Council, PO Box 500070, Dubai, United Arab Emirates

Main switchboard *+ (971) 4382 8800*

Main fax *+ (971) 4382 8600*

General enquiry email *enquiry@icc-cricket.com*

Website *www.icc-cricket.com*
