

# **ICC PLAYING HANDBOOK**

The official handbook for international cricket players,  
officials and administrators **2015-2016**

---

[www.icc-cricket.com](http://www.icc-cricket.com)

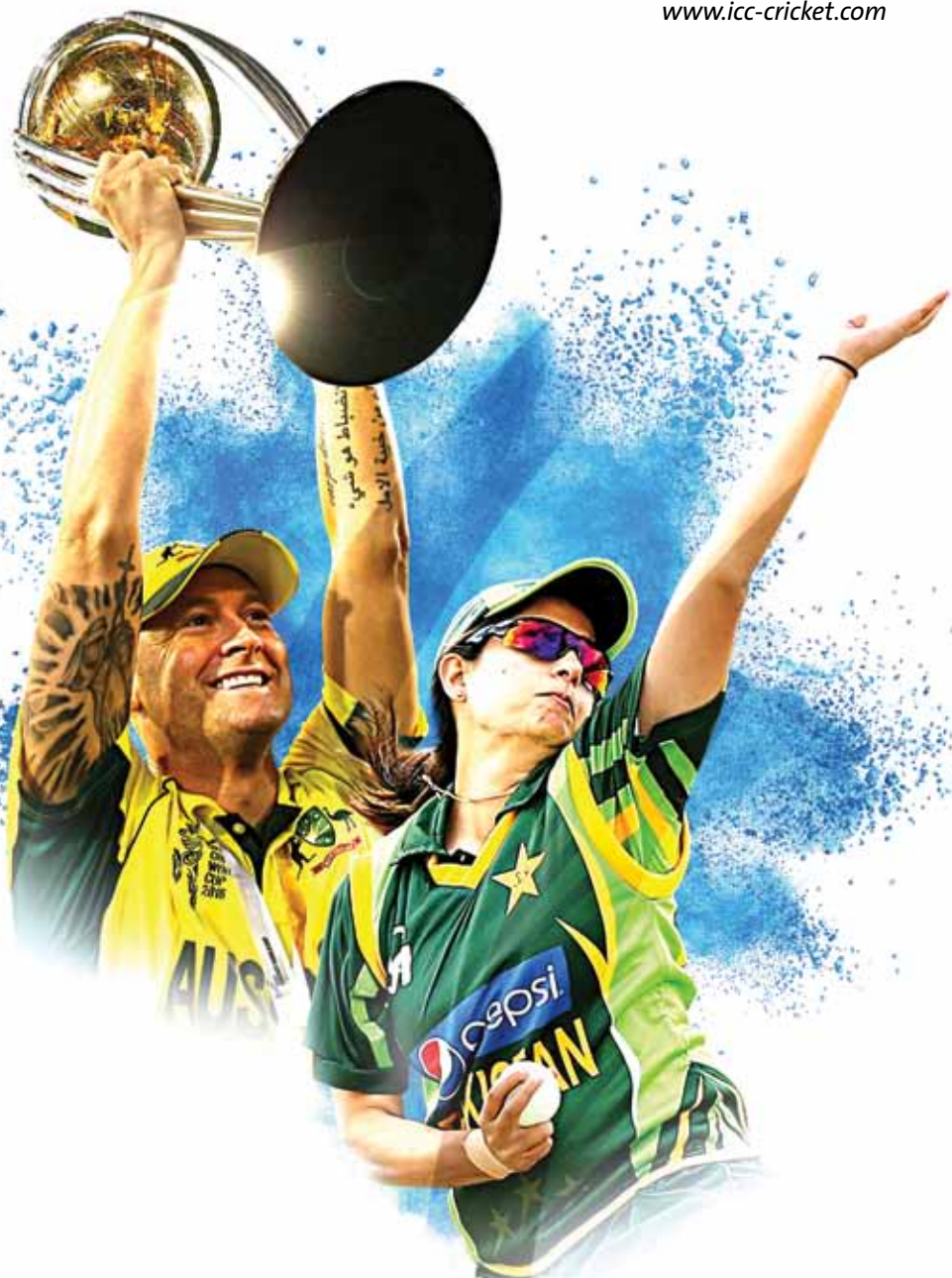

# ICC PLAYING HANDBOOK 2015 - 2016

The official handbook for international cricket players, officials and administrators

The print version of the handbook is a streamlined document that contains the key information that is referred to most regularly by officials and players (14 sections).

SECTION
01 Key ICC Contacts
02 ICC Member Countries
03 Standard Test Match Playing Conditions
04 Standard One-Day International Match Playing Conditions
05 Standard Twenty20 International Match Playing Conditions
08 ICC Women's Championship Playing Conditions
09 Women's Twenty20 Playing Conditions
13 ICC Code of Conduct for Players and Player Support Personnel
15 ICC Anti-Racism Code for Players and Player Support Personnel
16 ICC Anti-Doping Code
17 ICC Anti-Corruption Code for Participants
18 ICC Regulations for the Review of Bowlers Reported with Suspected Illegal Bowling Actions
19 Clothing and Equipment Rules and Regulations
20 Other ICC Regulations

Other rules and regulations that can be found on the ICC website include:

SECTION
06 Duckworth/Lewis/Stern
07 Women's Test Match Playing Conditions
12 ICC World Cricket League Standard Playing Conditions
14 ICC Code of Conduct for Umpires

Note: Please visit the Rules and Regulations page on the ICC website for the online version and the most up-to-date information, as some of the regulations in this book may be updated in the next 12 months: [www.icc-cricket.com](http://www.icc-cricket.com).



## KEY ICC CONTACTS

---

The print version of the handbook is a streamlined document that contains the key information that is referred to most regularly by officials and players.

The online versions of the handbook contain all sections.

# KEY ICC CONTACTS

## ICC CONTACT DETAILS

### ICC DUBAI

<b>Location</b>	Sh Mohammed Bin Zayed Road Dubai Sports City, Street 69 Dubai, UAE
<b>Address</b>	Dubai Sports City P.O. Box 500070 Dubai, UAE
<b>Main switchboard</b>	+ (971) 4 382 8800
<b>Fax</b>	+ (971) 4 382 8600
<b>Website</b>	<a href="http://www.icc-cricket.com">www.icc-cricket.com</a>
<b>General Enquiries</b>	<a href="mailto:enquiry@icc-cricket.com">enquiry@icc-cricket.com</a>
<b>Media Enquiries</b>	<a href="mailto:media@icc-cricket.com">media@icc-cricket.com</a>

### CRICKET OPERATIONS

<b>General Manager – Cricket</b>	<b>Geoff Allardice</b> <a href="mailto:geoff.allardice@icc-cricket.com">geoff.allardice@icc-cricket.com</a>
<b>Senior Cricket Operations Manager</b>	<b>Clive Hitchcock</b> <a href="mailto:clive.hitchcock@icc-cricket.com">clive.hitchcock@icc-cricket.com</a>
<b>Umpires and Referees Administration Manager</b>	<b>Adrian Griffith</b> <a href="mailto:adrian.griffith@icc-cricket.com">adrian.griffith@icc-cricket.com</a>

## ANTI-CORRUPTION UNIT

### ACU CONTACT DETAILS

ACU Hotline	+ (971) 4 341 7225
ACU Fax	+ (971) 4 340 4856
Enquiries	contactACU@icc-cricket.com
Media Enquiries	media@icc-cricket.com

All ACU media enquiries should be directed to the ICC Media Department.

### ACU STAFF DETAILS

Anti-Corruption Manager	<b>Arrie De Beer</b>
Mobile:	+27 82 800 8124
Email:	arrie.debeer@icc-cricket.com
Anti-Corruption Manager	<b>John Rhodes</b>
Mobile:	+61 438 535 009
Email:	john.rhodes@icc-cricket.com
Anti-Corruption Manager	<b>Richard Reynolds</b>
Mobile:	+44 793 337 3148
Email:	richard.reynolds@icc-cricket.com
Anti-Corruption Manager	<b>Niranjan Singh Virk</b>
Mobile:	+91 981 052 0683
Email:	niranjan.virk@icc-cricket.com
Anti-Corruption Manager	<b>Dharamveer Singh Yadav</b>
Mobile:	+91 971 139 5995
Email:	dharamveeryadav@icc-cricket.com
Anti-Corruption Manager	<b>Peter O'Shea</b>
Mobile:	+44 785 413 4811
Email:	peter.oshea@icc-cricket.com
Anti-Corruption Manager	<b>Bir Singh</b>
Mobile:	+91 981 091 0648
Email:	bir.singh@icc-cricket.com

### ANTI-DOPING

Anti-Doping Hotline	+ (971) 50 554 5891 (24 hours)
Anti-Doping Fax	+ (971) 4 340 9336
Anti-Doping Enquiries	anti-doping@icc-cricket.com

The print version of the handbook is a streamlined document that contains the key information that is referred to most regularly by officials and players.

The online versions of the handbook contain all sections.

# ICC MEMBER COUNTRIES

## ICC FULL MEMBERS (10 Members)

Australia	New Zealand	West Indies
Bangladesh	Pakistan	Zimbabwe
England	South Africa	
India	Sri Lanka	

## ICC ASSOCIATE MEMBERS (38 Members)

Afghanistan	Hong Kong	Nigeria
Argentina	Ireland	PNG
Belgium	Israel	Scotland
Bermuda	Italy	Singapore
Botswana	Japan	Suriname
Canada	Jersey	Tanzania
Cayman Islands	Kenya	Thailand
Denmark	Kuwait	UAE
Fiji	Malaysia	Uganda
France	Namibia	USA
Germany	Nepal	Vanuatu
Gibraltar	Oman	Zambia
Guernsey	The Netherlands	

## ICC AFFILIATE MEMBERS (57 Members)

Austria	Ghana	Philippines
Bahamas	Greece	Portugal
Bahrain	Hungary	Qatar
Belize	Indonesia	Romania
Bhutan	Iran	Russia
Brazil	Isle of Man	Rwanda
Bulgaria	Lesotho	Samoa
Cameroon	Luxembourg	Saudi Arabia
Chile	Malawi	Serbia
China	Maldives	Seychelles
Cook Islands	Mali	Sierra Leone
Costa Rica	Malta	Slovenia
Croatia	Mexico	South Korea
Cyprus	Morocco	Spain
Czech Republic	Mozambique	St Helena
Estonia	Myanmar	Swaziland
Falkland Islands	Norway	Sweden
Finland	Panama	Turkey
Gambia	Peru	Turks & Caicos Islands

Contact details for ICC Members can be found at the ICC website at <http://www.icc-cricket.com/about/g6/icc-members/overview>





# STANDARD **TEST MATCH** PLAYING CONDITIONS

---

03

The print version of the handbook is a streamlined document that contains the key information that is referred to most regularly by officials and players.

The online versions of the handbook contain all sections.

# STANDARD TEST MATCH PLAYING CONDITIONS

These playing conditions are applicable to all Test Matches from 5th July 2015 and supersede the previous version dated 1st October 2014. Included in this version are amendments to clauses 23.1, 40, 42, Appendix 1 clauses 2.2, 3.2 and 3.5, Appendix 3 clauses 3.1, 3.2 and 3.5 and new clauses 41.2, Appendix 1 clause 3.11 and Appendix 3 clause 8.

Except as varied hereunder, the Laws of Cricket (2000 Code - 5th Edition 2013) shall apply.

**Note:** All references to 'Governing Body' within the Laws of Cricket shall be replaced by 'ICC Match Referee'.

## 1 LAW 1 - THE PLAYERS

### 1.1 Law 1.1 - Number of Players

Law 1.1 shall be replaced by the following:

A match is played between two sides. Each side shall consist of 11 players, one of whom shall be captain.

### 1.2 Law 1.2 – Nomination of Players

Law 1.2 shall be replaced by the following:

- 1.2.1 Each captain shall nominate 11 players plus a maximum of 4 substitute fielders in writing to the ICC Match Referee before the toss. No player (member of the playing eleven) may be changed after the nomination without the consent of the opposing captain.
- 1.2.2 Only those nominated as substitute fielders shall be entitled to act as substitute fielders during the match, unless the ICC Match Referee, in exceptional circumstances, allows subsequent additions.
- 1.2.3 A player or player support personnel who has been suspended from participating in a match shall not, from the toss of the coin and for the remainder of the match thereafter:
  - a) Be nominated as, or carry out any of the duties or responsibilities of a substitute fielder, or
  - b) Enter any part of the playing area (which shall include the field of play and the area between the boundary and the perimeter boards) at any time, including any scheduled or unscheduled breaks in play.

A player who has been suspended from participating in a match shall be permitted from the toss of the coin and for the remainder of the match thereafter be permitted to enter the players' dressing room provided that the players' dressing room (or any part thereof) for the match is not within the playing area described in b) above (for example, the player is not permitted to enter the on-field 'dug-out')
- 1.2.4 All those nominated including those nominated as substitute fielders, must be eligible to play for that particular team and by such nomination the nominees shall warrant that they are so eligible.

1.2.5 In addition, by their nomination, the nominees shall be deemed to have agreed to abide by all the applicable ICC Regulations pertaining to international cricket and in particular, the Clothing and Equipment Regulations, the Code of Conduct for Players and Player Support Personnel (hereafter referred to as the ICC Code of Conduct), the Anti-Racism Code for Players and Player Support Personnel, the Anti-Doping Code and the Anti-Corruption Code.

### 1.3 Law 1.3 - Captain

The following shall apply in addition to Law 1.3 (a):

The deputy must be one of the nominated members of the playing eleven.

Each Member Board must nominate its 'Test Team Captain' to the ICC when appointed.

If the 'Test Team Captain' is not participating in a series, the relevant Home Board must nominate a replacement 'Test Team Captain' for the series. The Home Board shall advise the series Match Referee.

If the 'Test Team Captain' plays in a match without being the nominated captain for that match, he will be deemed to be the captain should any penalties be applied for over rate breaches under the Code of Conduct.

## 2 LAW 2 - SUBSTITUTES AND RUNNERS, BATSMAN OR FIELDER LEAVING THE FIELD, BATSMAN RETIRING, BATSMAN COMMENCING INNINGS

### 2.1 Law 2.1 Substitutes and Runners

Law 2.1 (a) (ii), 2.7 and 2.8 shall not apply. A runner for a batsman when batting is not permitted.

Law 2.1 (b) shall be amended as follows:

The umpires shall have discretion to allow, for other wholly acceptable reasons, a substitute fielder to act for a nominated player, at the start of the match, or at any subsequent time.

### 2.2 Law 2.5 - Fielder absent or leaving the field

Law 2.5 shall be replaced by the following:

If a fielder fails to take the field with his side at the start of the match or at any later time, or leaves the field during a session of play, the umpire shall be informed of the reason for his absence, and he shall not thereafter come on to the field during a session of play without the consent of the umpire. (See Law 2.6 as modified). The umpire shall give such consent as soon as practicable.

If the player is absent from the field for longer than 8 minutes, the following restrictions shall apply to their future participation in the match:

- 2.2.1 The player shall not be permitted to bowl in the match until he has either been able to field, or his team has subsequently been batting, for the total length of playing time for which he was absent (hereafter referred to as penance time), subject to a maximum cumulative penance time of 120 minutes. If any unexpired penance time remains at the end of an innings, it is carried forward to the next and subsequent innings of the match.
- 2.2.2 The player shall not be permitted to bat in the match until his team's batting innings has been in progress for the length of playing time that is equal to the unexpired penance time carried forward from the previous innings, subject to a maximum cumulative penance time of

120 minutes. However, once his side has lost five wickets in its batting innings, he may bat immediately. If any unexpired penance time remains at the end of that batting innings, it is carried forward to the next and subsequent innings of the match.

For the purposes of 2.2.1 and 2.2.2, playing time shall comprise the time play is in progress excluding lunch and tea intervals, intervals between innings and official drinks intervals. For clarity, a player's penance time will continue to expire after he is dismissed, for the remainder of his team's batting innings.

However, in the event of a batsman or a fieldsman already being off the field at the commencement of an interruption in play through ground, weather or light conditions or for other exceptional circumstances, he shall be allowed to count any such stoppage time as playing time, provided that he personally informs the umpires when he is fit enough to take the field had play been in progress.

Similarly, if at the commencement of an interruption in play through ground, weather or light conditions or for other exceptional circumstances, a player is on the field but still has some unexpired penalty time remaining from a previous absence, he shall automatically be allowed to count any such stoppage time as playing time, provided he returns to the field of play immediately after the interruption.

The restriction in clauses 2.2.1 and 2.2.2 above shall not apply if the player has suffered an external blow (as opposed to an internal injury such as a pulled muscle) whilst participating earlier in the match and consequently been forced to leave the field. Nor shall it apply if the player has been absent for very exceptional and wholly acceptable reasons (other than injury or illness).

- 2.2.3 Substitute fielders shall only be permitted in cases of injury, illness or other wholly acceptable reasons. 'Wholly acceptable reasons' should be limited to extreme circumstances and should not include what is commonly referred to as a 'comfort break'.

**Note:** Squad members of the fielding or batting team who are not playing in the match and who are not acting as substitute fielders shall be required to wear a team training bib whilst on the playing area (including the area between the boundary and the perimeter fencing).

### 3 LAW 3 - THE UMPIRES

#### 3.1 Law 3.1 - Appointment and attendance

Law 3.1 shall be replaced by the following:

The following rules for the selection and appointment of Test Match umpires shall be followed as far as it is practicable to do so:

- 3.1.1 The umpires shall control the game as required by the Laws (as read with these playing conditions), with absolute impartiality and shall be present at the ground at least two hours before the scheduled start of the first day's play, and at least 1.5 hours before the scheduled start of each succeeding day's play.
- 3.1.2 ICC shall establish an 'Elite Panel' of umpires who shall be contracted to the ICC.
- 3.1.3 Each Full Member shall nominate from its panel of first class umpires two umpires to an 'International Panel' and one umpire to a 'TV Panel'. (A third umpire may be nominated to the 'International Panel' with the written consent of the ICC).

- 3.1.4 ICC will appoint two umpires to stand in each Test Match. Neither of such umpires shall be from the same country as the participating teams and shall be selected from the 'Elite Panel' or the 'International Panel'.
- 3.1.5 As long as possible before each Test Match, the ICC will advise the Home Board of the names of its appointees and the Home Board will advise the Manager of the visiting team of all umpires' names.
- 3.1.6 In Test Matches where the DRS is used (see clause 3.2 below), ICC will appoint a third umpire who shall act as the emergency umpire and officiate in regard to the DRS. Such third umpire shall not be from the same country as the participating teams and shall be appointed from the 'Elite Panel' or the 'International Panel'.
- 3.1.7 In all other Test Matches, the third umpire will be appointed by the Home Board and he shall act as the emergency umpire and officiate in regard to TV replays. Such appointment shall be made from the 'Elite Panel', the 'International Panel' or the 'TV Panel'.
- 3.1.8 The Home Board shall also appoint a fourth umpire for each Test Match from its panel of first class umpires. The fourth umpire shall act as the emergency third umpire. In 'DRS' Test Matches the fourth umpire shall be appointed from the "International Panel" or the "TV Panel".
- 3.1.9 ICC shall appoint the match referee for all matches (ICC Match Referee).
- 3.1.10 The ICC Match Referee shall not be from the same country as the participating teams.
- 3.1.11 Neither team will have a right of objection to an umpire's or match referee's appointment.

### 3.2 Third Umpire/ TV Replay System (DRS)

In matches where the DRS is used, the playing conditions set out in Appendix 1 shall apply.

In matches where the DRS is not used, the playing conditions set out in Appendix 3 shall apply.

### 3.3 Law 3.2 - Change of umpire

Law 3.2 shall be replaced by the following:

An umpire shall not be changed during the match, other than in exceptional circumstances, unless he is injured or ill.

### 3.4 Law 3.4 - To inform captains and scorers

The following shall apply in addition to Law 3.4 (i):

The Home Board may provide for the ringing of a bell, which shall be rung 5 minutes before the termination of an interval, when the umpires shall go to the wickets. The Home Board shall inform the ICC Match Referee and the Manager of the visiting team at the start of the tour that this practice is to be adopted.

### 3.5 Law 3.8 - Fitness for play and Law 3.9 - Suspension of play in dangerous or unreasonable conditions.

- 3.5.1 The safety of all persons within the ground is of paramount importance to the ICC. In the event that any threatening circumstance, whether actual or perceived, comes to the attention of any umpire (including for example weather, pitch invasions, act of God, etc. See also clauses 3.5.4 and 3.5.5), then the players and officials should immediately be asked

to leave the field of play in a safe and orderly manner and to relocate to a secure and safe area (depending on each particular threat) pending the satisfactory passing or resolution of such threat or risk to the reasonable satisfaction of the umpires, ICC Match Referee, the head of the relevant ground authority, the head of ground security and/or the police as the circumstances may require.

Laws 3.8 & 3.9 shall be replaced by:

- 3.5.2 The umpires shall be the final judges of the fitness of the ground, weather and light for play. See clause 3.5.3 below and Law 7.2 (Fitness of the pitch for play).
- 3.5.3 Suspension of play for adverse conditions of ground, weather or light
- All references to ground include the pitch. See Law 7.1 (Area of pitch).
  - If at any time the umpires together agree, that the conditions of ground, weather or light are so bad that there is obvious and foreseeable risk to the safety of any player or umpire, so that it would be unreasonable or dangerous for play to take place, then they shall immediately suspend play, or not allow play to commence or to restart. The decision as to whether conditions are so bad as to warrant such action is one for the umpires alone to make, following consultation with the ICC Match Referee.

The fact that the grass and the ball are wet and slippery does not warrant the ground conditions being regarded as unreasonable or dangerous. If the umpires consider the ground is so wet or slippery as to deprive the bowler of a reasonable foothold, the fielders of the power of free movement, or the batsmen of the ability to play their strokes or to run between the wickets, then these conditions shall be regarded as so bad that it would be unreasonable for play to take place.

If circumstances are warranted, the umpires shall stop play and instruct the ground staff to take whatever action they can and use whatever equipment is necessary to remove as much dew as possible from the outfield when conditions become unreasonable or dangerous. The umpires may also instruct the ground staff to take such action during scheduled and unscheduled breaks in play.

The umpires shall disregard any shadow on the pitch from the stadium or from any permanent object on the ground.

- When there is a suspension of play it is the responsibility of the umpires to monitor the conditions. They shall make inspections as often as appropriate. Immediately the umpires together agree that conditions are suitable for play they shall call upon the players to resume the game.
  - If play is in progress up to the start of an agreed interval then it will resume after the interval unless the umpires together agree that the conditions of ground, weather or light are so bad that there is obvious and foreseeable risk to the safety of any player or umpire, so that it would be unreasonable or dangerous for play to take place.
- 3.5.4 Play may be suspended due to safety and security concerns by the umpires on the advice of the ICC Match Referee, the head of the relevant ground authority, the head of ground security or the police.

3.5.5 Where play is suspended under clause 3.5.4 above the decision to abandon or resume play shall be the responsibility of the ICC Match Referee who shall act only after consultation with the head of ground security and the police.

### 3.6 Light Meters

3.6.1 It is the responsibility of the ICC to supply light meters to the match officials to be used in accordance with these playing conditions.

3.6.2 All light meters shall be uniformly calibrated.

3.6.3 The umpires shall be entitled to use light meter readings as a guideline for determining whether the light is fit for play in accordance with the criteria set out in clause 3.5.3 (b) above.

3.6.4 Light meter readings may accordingly be used by the umpires:

- a) To determine whether there has been at any stage a deterioration or improvement in the light.
- b) As benchmarks for the remainder of a stoppage, match and/or series/event.

### 3.7 Use of artificial lights

If in the opinion of the umpires, natural light is deteriorating to an unfit level, they shall authorize the ground authorities to use the available artificial lighting so that the match can continue in acceptable conditions.

The lights are only to be used to enable a full day's play to be completed as provided in clause 16 below.

In the event of power failure or lights malfunction, the provisions relating to the delay or interruption of play due to bad weather or light shall apply.

**Notes:** Home Boards may, prior to the commencement of the series, seek the approval of ICC to amend this playing condition to provide that artificial lights will not be used at specific venues.

For day/night Test matches (see clause 16.1.12) the latest times at which the floodlights are to be switched on each day shall be decided by the Home Board prior to the match and the ICC Match Referee shall be duly informed.

### 3.8 Advertising on grounds, perimeter boards and sightscreens

#### 3.8.1 Advertising on grounds

The logos on outfields are to be positioned as follows:

- a) Behind the stumps – a minimum of 25.15 yards (23 meters) from the stumps.
- b) Midwicket/cover area – no advertising to be positioned within 30 yards (27.50 meters) of the centre of the pitch being used for the match.

**Note:** Advertising closer to the stumps as set out above which is required to meet 3D requirements for broadcasters may be permitted, subject to prior ICC approval having been obtained.

#### 3.8.2 Perimeter Boards

- a) Advertising on perimeter boards placed in front of the sightscreens is permitted save that the predominant colour of such advertising shall be of a contrasting colour to that of the ball.



- b) Advertising on perimeter boards behind the stumps at both ends shall not contain moving, flashing or flickering images and operators should ensure that the images are only changed or moved at a time that will not be distracting to the players or the umpires.
- c) In addition, the brightness of any electronic images shall be set at a level so that it is not a distraction to the players or umpires.

### 3.8.3 Sightscreens

- a) Sightscreens shall be provided at both ends of all grounds. For day-night Test matches, they will be black.
- b) Advertising shall be permitted on the sightscreen behind the striker, providing it is removed for the subsequent over from that end.
- c) Such advertising shall not contain flashing or flickering images and particular care should be taken by the operators that the advertising is not changed at a time which is distracting to the umpire.

## 4 LAW 4 - THE SCORERS

Law 4 shall apply.

## 5 LAW 5 - THE BALL

### 5.1 Law 5.2 - Approval and control of balls

Law 5.2 shall be replaced by the following:

The Home Board shall provide cricket balls of an approved standard for Test cricket and spare used balls for changing during a match, which shall also be of the same brand. Note: The Home Board shall be required to advise the Visiting Board of the brand of ball to be used in the match(es) at least 30 days prior to the start of the match(es). However, for day-night Test matches, the precise brand, type and colour of ball shall be subject to prior approval of the visiting Board.

The fielding captain or his nominee may select the ball with which he wishes to bowl from the supply provided by the Home Board. The fourth umpire shall take a box containing at least 6 new balls to the dressing room and supervise the selection of the ball.

The umpires shall retain possession of the match ball(s) throughout the duration of the match when play is not actually taking place. During play umpires shall periodically and irregularly inspect the condition of the ball and shall retain possession of it at the fall of a wicket, a drinks interval, or any other disruption in play.

### 5.2 Law 5.4 - New ball in a match of more than one day's duration

The following shall apply in addition to Law 5.4:

The prescribed number of overs shall be 80.

The umpire shall inform the other umpire and indicate to the batsmen and the scorers whenever a new ball is taken into play.

## 5.3 Law 5.5 - Ball lost or becoming unfit for play

The following shall apply in addition to Law 5.5:

However, if the ball needs to be replaced after 110 overs for any of the reasons above, it shall be replaced by a new ball. If the ball is to be replaced, the umpire shall inform the batsmen and the fielding captain.

## 5.4 Law 5.6 - Specifications

Law 5.6 shall not apply.

## 6 LAW 6 - THE BAT

The following shall apply in addition to Law 6:

Only Type A bats shall be used in Test Matches.

## 7 LAW 7 - THE PITCH

### 7.1 Law 7.3 - Selection and preparation

The following will apply in addition to Law 7.3:

7.1.1 The ground staff shall ensure that during the period prior to the start of play and during intervals, the pitch area shall be roped off so as to prevent unauthorised access. (The pitch area shall include an area at least 2 metres beyond the rectangle made by the crease markings at both ends of the pitch).

7.1.2 The fourth umpire shall ensure that, prior to the start of play and during any intervals, only authorised staff, the ICC match officials, players, team coaches and authorised television personnel shall be allowed access to the pitch area. Such access shall be subject to the following limitations:

- a) Only captains and team coaches may walk on the actual playing surface of the pitch area (outside of the crease markings).
- b) Access to the pitch area by television personnel shall be restricted to one camera crew (including one or two television commentators) of the official licensed television broadcaster(s) (but not news crews).
- c) No spiked footwear shall be permitted.
- d) No one shall be permitted to bounce a ball on the pitch, strike it with a bat or cause damage to the pitch in any other way.
- e) Access shall not interfere with pitch preparation.

7.1.3 In the event of any dispute, the ICC Match Referee will rule and his ruling will be final.

### 7.2 Law 7.4 - Changing the pitch

Law 7.4 shall be replaced by the following:

7.2.1 In the event of a pitch being considered too dangerous for play to continue in the estimation of the on-field umpires, they shall stop play and immediately advise the ICC Match Referee.

- 7.2.2 The on-field umpires and ICC Match Referee shall consult with both captains.
- 7.2.3 If the captains agree to continue, play shall resume.
- 7.2.4 If the decision is not to resume play, the on-field umpires together with the ICC Match Referee shall consider whether the existing pitch can be repaired and the match resumed from the point it was stopped. In considering whether to authorise such repairs, the ICC Match Referee must consider whether this would place either side at an unfair advantage, given the play that had already taken place on the dangerous pitch.
- 7.2.5 If the decision is that the existing pitch cannot be repaired, then the match is to be abandoned as a draw.
- 7.2.6 If the abandonment occurs on the first scheduled day of the match, the ICC Match Referee shall consult with the Home Board with the objective of finding a way for a new match to commence on the same date and venue. Such a match may be played either on the repaired pitch or on another pitch, subject to the ICC Match Referee and the relevant ground authority both being satisfied that the new pitch will be of the required Test standard. The playing time lost between the scheduled start time of the original match and the actual start time of the new match will be covered by the provisions of clause 16.
- 7.2.7 If it is not possible to start a new match on the scheduled first day of the original match, the relevant officials from the participating Boards shall agree on whether the match can be replayed within the existing tour schedule.
- 7.2.8 Throughout the above decision making processes, the ICC Match Referee shall keep informed both captains and the head of the ground authority. The head of the ground authority shall ensure that suitable and prompt public announcements are made.

### 7.3 Law 7.5 - Non-turf pitches

Law 7.5 shall not apply.

All matches shall be played on natural turf pitches. The use of PVA and other adhesives in the preparation of pitches is not permitted.

## 8 LAW 8 - THE WICKETS

### 8.1 Law 8.2 - Size of stumps

The following shall apply in addition to Law 8.2:

For televised matches the Home Board may provide a slightly larger cylindrical stump to accommodate the stump camera. When the larger stump is used, all three stumps must be exactly the same size.

## 9 LAW 9 - THE BOWLING, POPPING AND RETURN CREASES

### 9.1 Law 9.3 - The popping crease

Law 9.3 shall apply, except that the reference to 'a minimum of 6 ft' shall be replaced by 'a minimum of 15 yards (13.71 metres)'.

## 10 LAW 10 - PREPARATION AND MAINTENANCE OF THE PLAYING AREA

### 10.1 Law 10.1 - Rolling

The following shall apply in addition to Law 10.1:

- 10.1.1 Prior to tossing for choice of innings the artificial drying of the pitch and outfield shall be at the discretion of the ground curator. Thereafter and throughout the match the drying of the outfield may be undertaken at any time by the ground curator, but the drying of the affected area of the pitch shall be carried out only on the instructions and under the supervision of the umpires. The umpires shall be empowered to have the pitch dried without reference to the captains at any time they are of the opinion that it is unfit for play.
- 10.1.2 The umpires may instruct the ground curator to use any available equipment, including any roller for the purpose of drying the pitch and making it fit for play.
- 10.1.3 An absorbent roller may be used to remove water from the covers including the cover on the match pitch.

### 10.2 Law 10.6 - Maintenance of footholes

The following shall apply in addition to Law 10.6:

The umpires shall see that wherever possible and whenever it is considered necessary, action is taken during all intervals in play to do whatever is practicable to improve the bowler's foot holes. As soon as possible after the conclusion of each day's play, bowler's foot holes will be repaired.

### 10.3 Watering the outfield

The watering of the outfield will be permitted during the match subject to the following:

- 10.3.1 Such watering shall only be possible if the "watering plan" is requested by the ground curator and approved by the umpires before the match has started. Once the match has started, any such request will not be considered.
- 10.3.2 The consent of the captains is not required but the umpires shall advise both captains and the ICC Match Referee before the start of the match on what has been agreed.
- 10.3.3 The watering shall occur as soon as possible after the conclusion of the day's play.
- 10.3.4 The watering shall only be carried out to the extent that it is necessary to retain the good condition of the outfield.
- 10.3.5 The square and bowlers' run ups will be adequately covered prior to any watering taking place.
- 10.3.6 All ongoing matters of interpretation and implementation of watering requirements and regulations shall be resolved between the umpires and ground curator, but with the umpires retaining ultimate discretion over whether to approve any watering.

### 10.4 Protection and preparation of adjacent pitches during matches

The protection (by way of an appropriate cover) and preparation of pitches which are adjacent to the match pitch will be permitted during the match subject to the following:

- 10.4.1 Such measures will only be possible if requested by the ground curator and approved by the umpires before the start of the match.
- 10.4.2 Approval should only be granted where such measures are unavoidable and will not compromise the safety of the players or their ability to execute their actions with complete freedom.
- 10.4.3 The preparation work shall be carried out under the supervision of the fourth umpire.
- 10.4.4 Any necessary watering shall be carried out only to the extent necessary for such preparations and shall not be permitted in circumstances which may in any way affect the match pitch.
- 10.4.5 The consent of the captains is not required but the umpires shall advise both captains and the ICC Match Referee before the start of the match on what has been agreed.

## 11 LAW 11 - COVERING THE PITCH

### 11.1 Law 11.1 - Before the match

The following shall apply in addition to Law 11.1:

The pitch shall be entirely protected against rain up to the commencement of play.

### 11.2 Law 11.2 - During the match

Law 11.2 shall be replaced by the following:

The pitch shall be entirely protected against rain up to the commencement of play and for the duration of the period of the match. It shall be wholly covered at the termination of each day's play or providing the weather is fine, within a period of two hours thereafter.

**Note:** the covers must totally protect the pitch and also the pitch surroundings, a minimum 5 metres either side of the pitch and any worn or soft areas in the outfield.

### 11.3 Law 11.3 - Covering bowlers' run ups

Law 11.3 shall be replaced by the following:

The bowlers' run-ups shall be covered in inclement weather, in order to keep them dry, to a distance of at least 10 x 10 metres.

### 11.4 Law 11.4 - Removal of covers

Law 11.4 shall be replaced by the following:

All covers (including "hessian" or "scrim" covers used to protect the pitch against the sun) shall be removed not later than 2½ hours before the scheduled start of play provided it is not raining at the time, but the pitch will be covered again if rain falls prior to the commencement of play.

Attention is drawn to clauses 3.5 and 10.4 above.

## 12 LAW 12 - INNINGS

Law 12 shall apply subject to the following:

### 12.1 Law 12.1 (a) shall be replaced by the following:

A match shall be two innings per side subject to the provisions of Law 13.1.

### 12.2 Law 12.1 (b) and Law 12.3 (e) shall not apply.

- 12.3** Matches shall be of five days scheduled duration. The two participating countries may:
- 12.3.1 Provide for a rest day during the match, and/or a reserve day after the scheduled days of play.
  - 12.3.2 Play on any scheduled rest day, conditions and circumstances permitting, should a full day's play be lost on any day prior to the rest day.
  - 12.3.3 Play on any scheduled reserve day, conditions and circumstances permitting, should a full day's play be lost on any day. Play shall not take place on more than 5 days.
  - 12.3.4 Make up time lost in excess of five minutes in each day's play due to circumstances outside the game other than Acts of God.

#### **12.4 Law 12.4 - The toss**

Law 12.4 shall be replaced by the following:

The captains shall toss for the choice of innings, on the field of play and in the presence of the ICC Match Referee, who shall supervise the toss. The toss shall take place not earlier than 30 minutes, nor later than 15 minutes before the scheduled or any rescheduled time for the match to start. Note, however, the provisions of Law 1.3 (Captain).

**Note:** Law 12.5 requiring the captain of the side winning the toss to notify the opposing captain as soon as the toss is completed of his decision to bat or to field shall apply.

### **13 LAW 13 - THE FOLLOW-ON**

#### **13.1 Law 13.3 - First day's play lost**

If the provisions of clause 16.1.3 (b) are applied, the additional time is regarded as part of that day's play, i.e. it is the number of days remaining, and not the total number of hours available.

### **14 LAW 14 - DECLARATION AND FORFEITURE**

Law 14 shall apply.

### **15 LAW 15 - INTERVALS**

#### **15.1 Law 15.3 - Duration of intervals**

15.1.1 Luncheon Interval: The interval shall be of 40 minutes duration.

15.1.2 Tea Interval: The interval shall be of 20 minutes duration.

**Notes:** Home Boards may, prior to the start of the series and with the consent of the visiting Board, seek the approval of ICC to amend this playing condition to provide for lunch and tea intervals of 30 minutes each.

For day/night Test matches, the Home Boards with the consent of the visiting Board, may seek the approval of ICC to amend this playing condition provided the combined duration of the two intervals shall be equal to 60 minutes (see also clause 16.1.12).

#### **15.2 Law 15.8 - Tea interval - 9 wickets down**

Law 15.8 shall apply.

In addition, the provisions of Law 15.8 as applicable to the tea interval shall also apply to the lunch interval.

**15.3 Law 15.9 - Intervals for Drinks**

The provisions of Law 15.9 shall be strictly observed except that under conditions of extreme heat the umpires may permit extra intervals for drinks.

An individual player may be given a drink either on the boundary edge or at the fall of a wicket, on the field, provided that no playing time is wasted. No other drinks shall be taken onto the field without the permission of the umpires. Any player taking drinks onto the field shall be dressed in proper cricket attire. (subject to the wearing of bibs – refer to the note in clause 2.2.3).

**16 LAW 16 - START OF PLAY; CESSATION OF PLAY**

Law 16 shall apply subject to the following:

**16.1 Start and Cessation Times**

Subject to the provisions of clause 16.1.12 below, the Home Board shall determine the hours of play, subject to there being 6 hours scheduled play per day, and subject to:

**16.1.1 Minimum Overs in the Day**

Subject to clause 16.1.2 below:

- a) On days other than the last day, play shall continue on each day until the completion of a minimum target of 90 overs (or a minimum of 15 overs per hour) or the completion of the scheduled or rescheduled cessation time, whichever is the later but provided that play shall not continue for more than 30 minutes beyond the scheduled or rescheduled cessation time (permitted overtime). For the sake of clarity, if any of the minimum target number of overs have not been bowled at the completion of the permitted overtime, play shall cease upon completion of the over in progress. The overs not bowled shall not be made up on any subsequent day.
- b) On the last day, a minimum of 75 overs (or a minimum of 15 overs per hour) shall be bowled during the playing time other than the last hour of the match where clause 16.1.6 below shall apply. If any of the minimum of 75 overs, or as recalculated, have not been bowled when one hour of the scheduled playing time remains, the last hour of the match for the purposes of clause 16.1.6 shall be the hour immediately following the completion of these overs.

**16.1.2 Reduction in minimum overs**

Except in the last hour of the match, for which clause 16.1.6 makes provision, if play is suspended due to adverse weather or light or any other reason (other than normal intervals) for more than 1 hour on any day, the minimum number of overs shall be reduced by 1 over for each full 4 minutes of the aggregate playing time lost. For the avoidance of doubt, the aggregate of 1 hour shall be inclusive of any time that may have been brought forward from previous days due to playing time lost on such previous days under clause 16.1.3 (b) below.

**16.1.3 Making Up Lost Time****a) On The Day**

Subject to weather and light, except in the last hour of the match, in the event of play being suspended for any reason other than normal intervals, the playing time on that day shall be extended by the amount of time lost up to a maximum

of 1 hour. For the avoidance of doubt, the maximum of 1 hour shall be inclusive of any time that may have been added to the scheduled playing time due to playing time having been lost on previous days under clause 16.1.3 (b) below.

b) On Subsequent Days

If any time is lost and cannot be made up under clause 16.1.3 (a) above, additional time of up to a maximum of 30 minutes per day shall be added to the scheduled playing hours for the next day, and subsequent day(s) as required (to make up as much lost time as possible). Where appropriate this additional time shall be added prior to the scheduled start of the first session. In circumstances where it is not possible to add this additional time prior to the scheduled start of the first session, the additional time may be added to the second and/or the third sessions (see also clause 16.1.4). When such additional time is added, the minimum overs for that day shall be increased by one over for each four minutes of additional time or part thereof.

c) On the Last Day only (Refer Appendix 5)

Clause 16.1.3 (a) applies. However, for the purposes of this clause, the definition of playing time shall exclude the last hour. No time is made up in respect of any interruptions that commence after the start of the last hour.

Should play be interrupted prior to the last hour being signalled, the playing time lost will be made up (subject to the maximum of 1 hour described in (a) above) with the previously scheduled time for the last hour being updated to reflect the time made up during this interruption.

In order to determine the minimum overs to be bowled prior to the last hour and the rescheduled starting time for the last hour, it is necessary to complete the template in Appendix 5.

### 16.1.4 Change of Intervals

- a) If play has been suspended for any reason other than normal intervals for 30 minutes or more prior to the commencement of the scheduled or rescheduled tea interval on that day, the tea interval shall be delayed for 1/2 hour.
- b) Notwithstanding the provisions of clause a) above, the timings of intervals can be altered under Law 15.5 at any time on any day if playing time has been lost irrespective of whether the time has been lost on that day or on any previous days.

### 16.1.5 Change of Innings

Where there is a change of innings during a day's play (except where the change of innings occurs at lunch or tea or when play is suspended for any reason) 2 overs will be deducted from the minimum number of overs to be bowled.

The over in progress at the end of an innings is regarded as a completed over for the purposes of determining the minimum number of remaining overs to be bowled in the day.

### 16.1.6 Last Hour

Law 16.6, 16.7 and 16.8 will apply except that a minimum of 15 overs shall be bowled in the last hour and all calculations with regard to suspensions of play or the start of a new innings shall be based on 1 over for each full 4 minutes (refer clause 16.1.9 below).



On the final day, if both captains (the batsmen at the wicket may act for their captain) accept that there is no prospect of either side achieving a victory, they may agree to finish the match after (a) the time for the commencement of the last hour has been reached OR (b) there are a minimum of 15 overs to be bowled, whichever is the later.

- 16.1.7 Notwithstanding any other provision, there shall be no further play on any day, other than the last day, if a wicket falls or a batsman retires or if the players have occasion to leave the field during the last minimum over within 2 minutes of the scheduled cessation time or thereafter. This shall also apply to the additional time permitted in order to complete the minimum over requirement for the day. If an over is interrupted in these circumstances stumps shall be drawn for the day and the over shall be completed on the resumption of play.
- 16.1.8 An over completed on resumption of a new day's play shall be disregarded in calculating minimum overs for that day.
- 16.1.9 Stumps Drawn
- Except on the final day:
- In the event of play being suspended for any reason at or after the most recently scheduled or rescheduled cessation time, stumps shall be drawn upon play being suspended.
  - In the event of the players already being off the field for a suspension of play at the most recently rescheduled cessation time, then stumps will be drawn at that time.
- 16.1.10 The scoreboard shall show:
- the total number of overs bowled with the ball currently in use; and
  - the minimum number of overs remaining to be bowled in a day.
- 16.1.11 Penalties shall apply for slow over rates (refer ICC Code of Conduct and see clause 16.3 below).
- 16.1.12 Home Boards may, prior to the commencement of a Test, and with the agreement of the visiting Board, seek the approval of ICC to play the match as a day/night Test. In such a case the hours of play shall be determined by agreement between the participating Boards subject to there being 6 hours scheduled play per day.

## 16.2 Extra Time

- 16.2.1 The umpires may decide to play 30 minutes (a minimum of eight overs) extra time at the end of any day (other than the last day) if requested by either captain if, in the umpires opinion, it would bring about a definite result on that day [this is in addition to the additional time provided for in clause 16.1.3 above]. If the umpires do not believe a result can be achieved no extra time shall be allowed.

If it is decided to play such extra time on one or more of these days, the whole period shall be played out even though the possibility of finishing the match may have disappeared before the full period has expired.

Only the actual amount of playing time up to the maximum 30 minutes extra time by which play is extended on any day shall be deducted from the total number of hours of play remaining, and the match shall end earlier on the final day by the amount of time by which play was previously extended under this clause.

16.2.2 The umpires may decide to play 15 minutes (a minimum of four overs) extra time at the scheduled lunch or tea interval of any day if requested by either captain if, in the umpires' opinion, it would bring about a definite result in that session. If the umpires do not believe a result can be achieved no extra time shall be allowed.

If it is decided to play such extra time, the whole period shall be played out even though the possibility of finishing the match may have disappeared before the full period has expired.

Only the actual amount of playing time up to the maximum 15 minutes extra time by which play is extended on any day shall be deducted from the total number of hours of play remaining, and the following session of play shall be reduced by the amount of time by which play was previously extended under this clause.

For the avoidance of doubt, Law 15.8, as amended by Clause 15.2, shall still apply subsequent to the application of this clause, i.e. when 9 wickets are down following the extra 15 minutes. However, this clause shall not apply when Law 15.8, as amended by Clause 15.2, has already been applied, i.e. the 15 minutes shall not be added at the end of 30 minutes extra time.

### 16.3 Minimum Over Rates

The minimum over rate to be achieved in Test Matches will be 15 overs per hour.

The actual over rate will be calculated at the end of the match by the umpires and will be the average rate which is achieved by the fielding team across both of the batting team's innings.

In calculating the actual over rate for the match, allowances will be given as follows:

- 16.3.1 The time lost as a result of treatment given to a player by an authorised medical personnel on the field of play;
- 16.3.2 The time lost as a result of a player being required to leave the field as a result of a serious injury;
- 16.3.3 The time taken for all third umpire referrals and consultations and any umpire or player reviews;
- 16.3.4 The time lost as a result of time wasting by the batting side; and
- 16.3.5 The time lost due to all other circumstances that are beyond the control of the fielding side.
- 16.3.6 2 minutes per wicket taken, provided that such wicket results in the subsequent batsmen immediately commencing his innings. For the avoidance of any doubt, no time allowance will be given for the final wicket of an innings or where a wicket falls immediately prior to any interval;
- 16.3.7 4 minutes per drinks break taken (one per session).

In the event of any time allowances being granted to the fielding team under 16.3.4 above (time wasting by batting team), then such time shall be deducted from the allowances granted to such batting team in the determination of its over rate.

If a side is bowled out in  $3\frac{1}{2}$  hours or less (taking into account all of the time allowances set out above) in any particular innings, no account will be taken of the actual over rate in that innings when calculating the actual over rate at the end of the match.

**17 LAW 17 - PRACTICE ON THE FIELD**

Law 17 shall apply subject to the following:

**17.1 Law 17.1 - Practice on the pitch or the rest of the square**

Law 17.1 shall apply subject to the following:

- a) The use of the square for practice on any day of any match will be restricted to any netted practice area or bowling strips specifically prepared on the edge of the square for that purpose.
- b) Bowling practice on the bowling strips referred to in (a) above shall also be permitted during the interval (and change of innings if not the interval) unless the umpires consider that, in the prevailing conditions of ground and weather, it will be detrimental to the surface of the square.

**17.2 Law 17.3 - Practice on the outfield between the call of play and the call of time**

Law 17.3 shall apply save that Law 17.3 (c) shall be replaced with the following:

- c) There shall be no bowling or batting practice on the outfield. Bowling a ball, using a short run up to a player in the outfield is not to be regarded as bowling practice but shall be subject to the law.

**18 LAW 18 - SCORING RUNS**

Law 18 shall apply.

**19 LAW 19 - BOUNDARIES**

Law 19 shall apply subject to the following:

**19.1 Law 19.1 - The boundary of the field of play**

The following shall apply in addition to Law 19.1:

The playing area shall be a minimum of 150 yards (137.16 metres) from boundary to boundary square of the pitch, with the shorter of the two square boundaries being a minimum 65 yards (59.43 metres). The straight boundary at both ends of the pitch shall be a minimum of 70 yards (64.00 metres). Distances shall be measured from the centre of the pitch to be used.

In all cases the aim shall be to provide the largest playing area, subject to no boundary exceeding 90 yards (82.29 meters) from the centre of the pitch to be used.

Any ground which has been approved to host international cricket prior to 1st October 2007 or which is currently under construction as of this date which is unable to conform to these new minimum dimensions shall be exempt. In such cases the regulations in force immediately prior to the adoption of these regulations shall apply.

**19.2 Law 19.2 - Defining the boundary - boundary marking**

The following shall apply in addition to Law 19.2:

All boundaries must be designated by a rope or similar object of a minimum standard as authorised by the ICC from time to time. Where appropriate the rope should be a required minimum distance (3 yards (2.74 metres) minimum) inside the perimeter fencing or advertising signs. For grounds with a large playing area, the maximum length of boundary should be used before applying the minimum 3 yards (2.74 metres) between the boundary and the fence.

## 19.3 Law 19.3 - Scoring a boundary

The following shall be added to Law 19.3:

If an unauthorized person enters the playing arena and handles the ball, the umpire at the bowler's end shall be the sole judge of whether the boundary allowance should be scored or the ball be treated as still in play or called dead ball if a batsman is liable to be out as a result of the unauthorized person handling the ball. See also Law 19.1 (c).

## 20 LAW 20 - LOST BALL

Law 20 shall apply.

## 21 LAW 21 - THE RESULT

Law 21 shall apply subject to the following:

### 21.1 Law 21.2 - A win-one innings match

Law 21.2 shall not apply

### 21.2 Law 21.3 – Umpire (ICC Match Referee) awarding a match

Law 21.3 shall be replaced by the following:

- a) A match shall be lost by a side which either
  - i) concedes defeat or
  - ii) in the opinion of the ICC Match Referee refuses to play and the ICC Match Referee shall award the match to the other side.
- b) If an umpire considers that an action by any player or players might constitute a refusal by either side to play then the umpires together shall inform the ICC Match Referee of this fact. The ICC Match Referee shall together with the umpires ascertain the cause of the action. If the ICC Match Referee, after due consultation with the umpires, then decides that this action does constitute a refusal to play by one side, he shall so inform the captain of that side. If the captain persists in the action the ICC Match Referee shall award the match in accordance with (a)(ii) above.\*
- c) If action as in (b) above takes place after play has started and does not constitute a refusal to play:
  - i) playing time lost shall be counted from the start of the action until play recommences, subject to Law 15.5 (Changing agreed times for intervals).
  - ii) the time for close of play on that day shall be extended by this length of time, subject to Law 3.9 (Suspension of play in dangerous and unreasonable conditions) and the provisions of clause 16.
  - iii) if applicable, no overs shall be deducted during the last hour of the match solely on account of this time.

\*N/B In addition to the consequences of any refusal to play prescribed under this clause, any such refusal, whether temporary or final, may result in disciplinary action being taken against the captain and team responsible under the ICC Code of Conduct.

### 21.3 Law 21.4 – Matches in which there is an agreement under Law 12.1(b)

Law 21.4 shall not apply.

**21.4 Law 21.8 - Correctness of result**

Any query on the result of the match as defined in Laws 21.1, 21.3, 21.5, 21.8 and 21.10 shall be resolved as soon as possible and a final decision made by the umpires at close of play.

**22 LAW 22 - THE OVER**

Law 22 shall apply subject to the addition of the following to Law 22.5:

**22.1 Law 22.5 - Umpire miscounting**

Whenever possible the third umpire shall liaise with the scorers and if possible inform the on-field umpires if the over has been miscounted.

**23 LAW 23 - DEAD BALL**

law 23 shall apply subject to the addition of the following to law 23.4.

**23.1 Law 23.4 – Umpire calling and signalling ‘Dead Ball’**

In a match where cameras are being used on or over the field of play (e.g. Spydercam), should a ball that has been hit by the batsman make contact, while still in play, with the camera, its apparatus or its cable, either umpire shall call and signal ‘dead ball’. The ball shall not count as one of the over and no runs shall be scored. If the delivery was called a no ball it shall count and the no ball penalty applied. No other runs (including penalty runs) apart from the no ball penalty shall be scored.

Should a ball thrown by a fielder make contact with a camera on or over the field of play, its apparatus or its cable, either umpire shall call and signal dead ball. Unless this was already a no-ball or wide, the ball shall count as one of the over. All runs scored to that point shall count, plus the run in progress if the batsmen have already crossed.

Refer also to Appendix 1 clause 3.11 and Appendix 3 clause 8.

**24 LAW 24 - NO BALL**

Law 24 shall apply subject to the following:

**24.1 Law 24.1 - Mode of delivery**

Law 24.1 (b) shall be replaced by the following:

The bowler may not deliver the ball underarm. If a bowler bowls a ball underarm the umpire shall call and signal no ball, and the ball is to be re-bowled overarm.

**24.2 Fair Delivery - the feet**

Law 24.5 shall apply, subject to the final paragraph being replaced by the following:

If the bowler's end umpire is satisfied that any of these three conditions have not been met, he shall call and signal No ball.

**25 LAW 25 - WIDE BALL****25.1 Law 25.1 - Judging a Wide**

Law 25 shall apply with the following addition to Law 25.1 (Judging a wide):

For bowlers attempting to utilise the rough outside a batsman's leg stump, not necessarily as a negative tactic, the strict limited over wide interpretation shall be applied.

For bowlers whom umpires consider to be bowling down the leg side as a negative tactic, the strict limited over wide interpretation shall be applied.

## 26 LAW 26 - BYE AND LEG BYE

Law 26 shall apply.

## 27 LAW 27 - APPEALS

Law 27 shall apply.

## 28 LAW 28 - THE WICKET IS DOWN

Law 28 shall apply.

## 29 LAW 29 - BATSMAN OUT OF HIS GROUND

Law 29 shall apply.

## 30 LAW 30 - BOWLED

Law 30 shall apply.

## 31 LAW 31 - TIMED OUT

Law 31 shall apply.

Refer also to clause 42.9 (Law 42.10).

## 32 LAW 32 - CAUGHT

Law 32 shall apply.

## 33 LAW 33 - HANDLED THE BALL

Law 33 shall apply.

## 34 LAW 34 - HIT THE BALL TWICE

Law 34 shall apply.

## 35 LAW 35 - HIT WICKET

Law 35 shall apply.

## 36 LAW 36 - LEG BEFORE WICKET

Law 36 shall apply.

## 37 LAW 37 - OBSTRUCTING THE FIELD

Law 37 shall apply. For the avoidance of doubt, if an umpire feels that a batsman, in running between the wickets, has significantly changed his direction without probable cause and thereby obstructed a fielder's attempt to effect a run out, the batsman should, on appeal, be given out, obstructing the field. It shall not be relevant whether a run out would have occurred or not.

If the change of direction involves the batsman crossing the pitch, Law 42.14 shall also apply.

See also paragraph 2.4 of Appendix 1 and paragraph 5 of Appendix 3.

## 38 LAW 38 - RUN OUT

Law 38 shall apply.

**39 LAW 39 - STUMPED**

Law 39 shall apply.

**40 LAW 40 - THE WICKET-KEEPER**

Law 40.4 shall be replaced by the following:

After the ball comes into play and before it reaches the striker, it is unfair if the wicket-keeper significantly alters his position in relation to the striker's wicket, except for the following:

- i) movement of a few paces forward for a slower delivery, unless in doing so it brings him within reach of the wicket.
- ii) lateral movement in response to the direction in which the ball has been delivered.
- ii) movement in response to the stroke that the striker is playing or that his actions suggest he intends to play, however for the provisions of Law 40.3 (Position of the wicket-keeper) shall apply.

In the event of unfair movement by the wicket-keeper, either umpire shall call and signal Dead ball.

**41 LAW 41 - THE FIELDER**

Law 41 shall apply subject to the following:

**41.1 Law 41.1 - Protective equipment**

In addition to Law 41.1:

The exchanging of protective equipment between members of the fielding side on the field shall be permitted provided that the umpires do not consider that it constitutes a waste of playing time.

**41.2 Law 41.7 - Movement by fielders and Law 41.8 Definition of significant movement shall be replaced by the following:**

Movement by any fielder other than the wicket keeper

Any movement by any fielder, excluding the wicket keeper, after the ball comes into play and before the ball reaches the striker, is unfair except for the following:

- i) minor adjustments to stance or position in relation to the striker's wicket.
- ii) movement by any fielder in the outfield towards the striker or the striker's wicket that does not significantly alter the fielder's position.
- iii) movement by any fielder in response to the stroke that the striker is playing or that his actions suggest he intends to play.

Notwithstanding (iii) above, in all circumstances Law 41.5 (Limitation of on side fielders) shall apply.

In the event of such unfair movement, either umpire shall call and signal Dead ball as soon as possible after the delivery of the ball. Note also the provisions of Law 42.4 (Deliberate attempt to distract the striker).

Refer also to clause 40 - Law 40.4 (Movement by the wicket-keeper).

## 42 LAW 42 - FAIR AND UNFAIR PLAY

Law 42 shall apply subject to the following:

### 42.1 Law 42.1 – Fair and unfair play – responsibility of captains

Law 42.1 shall apply.

### 42.2 Law 42.2 – Fair and unfair play – responsibility of umpires

Law 42.2 shall apply.

### 42.3 Law 42.3 - The match ball - changing its condition

Law 42.3 shall apply, subject to the following:

Law 42.3 (d) and (e) shall be replaced with the following:

If the umpires together agree that the deterioration of the ball is inconsistent with the use it has received, they shall consider that there has been a contravention of this Law. They shall then decide together whether they can identify the player(s) responsible for such conduct.

42.3.1 If it is possible to identify the player(s) responsible:

- a) Change the ball forthwith. The batsman at the wicket shall choose the replacement ball from a selection of six other balls of various degrees of usage (including a new ball) and of the same brand as the ball in use prior to the contravention.

Additionally the bowler's end umpire shall:

- b) Award 5 penalty runs to the batting side.
- c) Inform the captain of the fielding side of the reason for the action taken.
- d) Inform the captain of the batting side as soon as practicable of what has occurred.
- e) Together with the other umpire report the incident to the ICC Match Referee who shall take action as is appropriate against the player(s) responsible for the conduct under the ICC Code of Conduct.

42.3.2 If it is not possible to identify the player(s) responsible:

- a) Change the ball forthwith. The umpires shall choose the replacement ball for one of similar wear and of the same brand as the ball in use prior to the contravention.
- b) The bowler's end umpire shall issue the captain with a first and final warning, and
- c) Advise him that should there be any further incident by that team during the remainder of the match, steps 42.1.1 a) to e) above will be adopted, with the captain deemed under e) to be the player responsible.

### 42.4 Law 42.4 - Deliberate attempt to distract striker

Law 42.4 shall apply subject to the following:

In addition, the umpires shall report the incident to the ICC Match Referee under the ICC Code of Conduct.



**42.5 Law 42.5 - Deliberate distraction or obstruction of batsman**

Law 42.5 shall apply subject to the following:

In addition, the umpires shall report the incident to the ICC Match Referee under the ICC Code of Conduct.

**42.6 Law 42.6 - Dangerous and Unfair Bowling****42.6.1 Law 42.6 (a) - The Bowling of Fast Short Pitched Balls**

Law 42.6 (a) shall be replaced by the following:

- a) A bowler shall be limited to two fast short-pitched deliveries per over.
- b) A fast short-pitched delivery is defined as a ball, which passes or would have passed above the shoulder height of the striker standing upright at the popping crease.
- c) The umpire at the bowler's end shall advise the bowler and the batsman on strike when each fast short pitched delivery has been bowled.
- d) In addition, for the purpose of this regulation and subject to clause 42.4.1 (f) below, a ball that passes above head height of the batsman, that prevents him from being able to hit it with his bat by means of a normal cricket stroke shall be called a wide.
- e) For the avoidance of doubt any fast short pitched delivery that is called a wide under this playing condition shall also count as one of the allowable short pitched deliveries in that over.
- f) In the event of a bowler bowling more than two fast short-pitched deliveries in an over as defined in clause 42.4.1 (b) above, the umpire at the bowler's end shall call and signal no ball on each occasion. A differential signal shall be used to signify a fast short pitched delivery. The umpire shall call and signal 'no ball' and then tap the head with the other hand.
- g) If a bowler delivers a third fast short pitched ball in an over, the umpire, after the call of no ball and when the ball is dead, shall caution the bowler, inform the other umpire, the captain of the fielding side and the batsmen at the wicket of what has occurred. This caution shall apply throughout the innings.
- h) If there is a second instance of the bowler being no balled in the innings for bowling more than two fast short pitched deliveries in an over, the umpire shall advise the bowler that this is his final warning for the innings.
- i) Should there be any further instance by the same bowler in that innings, the umpire shall call and signal no ball and when the ball is dead direct the captain to take the bowler off forthwith.  
If necessary, the over shall be completed by another bowler, who shall neither have bowled the previous over, or part thereof, nor be allowed to bowl the next over, or part thereof.
- j) The bowler thus taken off shall not be allowed to bowl again in that innings.
- k) The umpire will report the occurrence to the other umpire, the batsmen at the wicket and as soon as possible to the captain of the batting side.

- l) The umpires may then report the matter to the ICC Match Referee who shall take such action as is considered appropriate against the captain and the bowler concerned. (Refer also to Law 42.1 Fair and Unfair Play - Responsibility of the Captains.)

The above is not a substitute for clause 42.7 below which umpires are able to apply at any time.

#### **42.6.2 Law 42.6 (b) Bowling of High Full Pitched Balls**

Law 42.6 (b) shall be replaced by the following:

- a) Any delivery, which passes or would have passed on the full above waist height of the striker standing upright at the popping crease is deemed unfair, whether or not it is likely to inflict physical injury on the striker.
- b) In the event of a bowler bowling a high full pitched ball as defined in clause 42.4.2 (a) above, the umpire at the bowler's end shall call and signal no ball.

If, in the opinion of the umpire, such a delivery is considered likely to inflict physical injury on the batsman, the umpire at the bowler's end shall, in addition to calling and signalling no ball, when the ball is dead, caution the bowler and issue a first and final warning. The umpire shall inform the other umpire, the captain of the fielding side and the batsmen at the wicket of what has occurred.

- c) Should there be any further instance (where a high full pitched ball is bowled and is considered likely to inflict physical injury on the batsman) by the same bowler in that innings, the umpire shall, in addition to calling and signalling no ball, when the ball is dead, direct the captain to take the bowler off forthwith. If necessary, the over shall be completed by another bowler, who shall neither have bowled the previous over, or part thereof, nor be allowed to bowl the next over, or part thereof.
- d) The bowler thus taken off shall not be allowed to bowl again in that innings.
- e) The umpire will report the occurrence to the other umpire, the batsman at the wicket and as soon as possible to the captain of the batting side.
- f) The umpires may then report the matter to the ICC Match Referee who shall take such action as is considered appropriate against the captain and the bowler concerned. (Refer also to Law 42.1 Fair and Unfair Play - Responsibility of the Captains.)

#### **42.7 Law 42.7 - Dangerous and Unfair Bowling - Action by the umpire**

Law 42.7 shall be replaced by the following:

Regardless of any action taken by the umpire as a result of a breach of clauses 42.4.1, 42.4.2 and 42.6 the following shall apply at any time during the match.

- 42.7.1 The bowling of fast short pitched balls is unfair if in the opinion of the umpire at the bowler's end he considers that by their repetition and taking into account their length, height and direction, they are likely to inflict physical injury on the striker, irrespective of the protective clothing and equipment he may be wearing. The relative skill of the striker shall also be taken into consideration.

42.7.2 In the event of such unfair bowling, the umpire at the bowler's end shall adopt the following procedure:

- a) In the first instance the umpire shall call and signal no ball, caution the bowler and inform the other umpire, the captain of the fielding side and the batsmen of what has occurred.
- b) If this caution is ineffective, he shall repeat the above procedure and indicate to the bowler that this is a final warning.
- c) Both the above caution and final warning shall continue to apply even though the bowler may later change ends.
- d) Should there be any further instance by the same bowler in that innings, the umpire shall call and signal no ball and when the ball is dead direct the captain to take the bowler off forthwith. If necessary, the over shall be completed by another bowler, who shall neither have bowled the previous over, or part thereof, nor be allowed to bowl the next over, or part thereof. See Law 22.8. (Bowler Incapacitated or Suspended during an Over).
- e) The bowler thus taken off shall not be able to bowl again in that innings.
- f) The umpire will report the occurrence to the other umpire, the batsmen at the wicket and as soon as possible to the captain of the batting side.
- g) The umpires may then report the matter to the ICC Match Referee who shall take such action as is considered appropriate against the captain and the bowler concerned. (Refer also to Law 42.1 Fair and Unfair Play - Responsibility of the Captains.)

Should the umpires initiate the caution and warning procedures set out in Clauses 42.6.1, 42.6.2, and 42.7 such cautions and warnings are not to be cumulative.

#### **42.8 Law 42.8 - Deliberate bowling of High Full Pitched Balls**

Law 42.8 shall be replaced by the following:

If the umpire considers that a high full pitch delivery which is deemed unfair as defined in clause 42.4.2 was deliberately bowled, then the caution and warning process shall be dispensed with.

The umpire at the bowler's end shall:

- 42.8.1 Call and signal no ball.
- 42.8.2 When the ball is dead, direct the captain to take the bowler off forthwith.
- 42.8.3 Not allow the bowler to bowl again in that innings.
- 42.8.4 Ensure that the over is completed by another bowler, provided that the bowler does not bowl two overs or part thereof consecutively.
- 42.8.5 Report the occurrence to the other umpire, to the captain of the batting side and, together with the other umpire, to the ICC Match Referee who shall take such action as is considered appropriate against the captain and the bowler concerned. (Refer also to Law 42.1 Fair and Unfair Play Responsibility of the Captains).

## **42.9 Law 42.9 - Time Wasting by the Fielding Side**

Law 42.9 shall apply subject to Law 42.9 (c) being replaced by the following:

If either umpire considers that there is any further waste of time in that innings, by any member of the fielding side the umpire concerned shall:

42.9.1 Call and signal dead ball if necessary, and;

42.9.2 Award 5 penalty runs to the batting side (see Law 42.17).

42.9.3 Inform the other umpire, the batsmen at the wicket and as soon as possible the captain of the batting side of what has occurred.

42.9.4 Together with the other umpire, report the occurrence to the ICC Match Referee who shall take such action as is considered appropriate against the captain and the team concerned under the ICC Code of Conduct.

## **42.10 Law 42.10 - Batsman Wasting Time**

Law 42.10 shall apply, subject to the following:

If the incoming batsman is not in position to take guard or his partner not ready to receive the next ball within 2 minutes of the fall of the previous wicket, the action should be regarded by the umpires as time wasting and the provisions of Law 42.10 shall apply.

In addition, the umpires shall report the incident to the ICC Match Referee under the ICC Code of Conduct.

## **42.11 Law 42.11 - Damaging the pitch – area to be protected**

Law 42.11 shall apply.

## **42.12 Law 42.12 – Bowler running on protected area after delivering the ball**

Law 42.12 shall apply, subject to 42.12 (d) (iv) being replaced by the following:

In addition, the umpires may report the incident to the ICC Match Referee under the ICC Code of Conduct.

## **42.13 Law 42.13 – Fieldsman damaging the pitch**

Law 42.13 shall apply.

In addition, the umpires shall report the incident to the ICC Match Referee under the ICC Code of Conduct.

## **42.14 Law 42.14 Batsman damaging the pitch**

Law 42.14 shall apply.

In addition, the umpires shall report the incident to the ICC Match Referee under the ICC Code of Conduct.

See also clause 37 above.

## **42.15 Law 42.15 – Bowler attempting to run out non-striker before delivery**

Law 42.15 shall be replaced by the following:

The bowler is permitted, before releasing the ball and provided he has not completed his usual delivery swing, to deliberately attempt to run out the non-striker. Whether the attempt is successful or not, the ball shall not count as one of the over. If the bowler fails in an attempt to run out the non-striker, the umpire shall call and signal Dead ball as soon as possible.

**42.16 Law 42.16 – Batsman stealing a run**

Law 42.16 shall apply, subject to 42.16(vi) being replaced by the following:  
In addition, the umpires may report the incident to the ICC Match Referee under the ICC Code of Conduct.

**42.17 Law 42.17 – Penalty runs**

Law 42.17 shall apply.

**42.18 Law 42.18 – Players' conduct**

Law 42.18 shall apply, subject to 42.18(iii) being replaced by the following:  
In addition, the umpires shall report the incident to the ICC Match Referee under the ICC Code of Conduct.

**42.19 Use of Electronic Communications Equipment**

The use of electronic communication devices and equipment of any kind to communicate with players on the field of play shall not be permitted.

## APPENDIX 1

### Decision Review System (DRS) - Playing Conditions

#### 1 GENERAL

- 1.1 The DRS includes:
  - The process for the referral by the on-field umpires of a decision to the third umpire and/or the consultation process (between the on-field umpire(s) and the third umpire) initiated by the on-field umpire(s) as set out in paragraph 2 below and which have been collectively termed in these playing conditions as an “Umpire Review”; and
  - The process initiated by the players for the review of an on-field umpire’s decision (by means of a consultation between the on-field umpire(s) and the third umpire) as set out in paragraph 3 below and which has been termed in these playing conditions as the “Player Review”.
- 1.2 The Home Board will be required to ensure that the television technology specifications set out in Appendix 2 are provided.
- 1.3 In particular, the Home Board is to ensure that a separate room is provided for the third umpire and that he has access to the television equipment and technology as specified in Appendix 2 so as to be in the best position to facilitate the referral and/or consultation processes referred to in paragraphs 2 (Umpire Review) and 3 (Player Review) below.
- 1.4 The ICC shall appoint an independent technology expert (ICC Technical Official) to be present at every series to assist the third umpire and to protect the integrity of the DRS process.

#### 2 UMPIRE REVIEW

In the circumstances detailed in paragraphs 2.1, 2.2, 2.3, 2.4 and 2.5 below, the on-field umpire has the discretion to refer the decision to the third umpire or, in the case of 2.2(a), 2.4 and 2.5, to consult with the third umpire before making the decision and should take a common sense approach.

Save for requesting the umpire to review his decision under paragraph 3 (Player Review) below, players may not appeal to the umpire to use the Umpire Review - breach of this provision would constitute dissent and the player could be liable for discipline under the ICC Code of Conduct.

The third umpire shall call for as many replays from any camera angle as is necessary to reach a decision. As a guide, a decision should be made within 30 seconds whenever possible, but the third umpire shall have the discretion to take more time.

##### 2.1 Run Out, Stumping and Hit Wicket Decisions

- a) The on-field umpire shall be entitled to refer an appeal for a run-out, stumping or hit wicket to the third umpire.
- b) An on-field umpire wishing to refer a decision to the third umpire shall signal to the third umpire by making the shape of a TV screen with his hands.
- c) In the case of a referral of a hit wicket or stumping decision, the third umpire shall first check the fairness of the delivery (all modes of No ball except for the bowler using an illegal action, [for clarity, a specific type of banned delivery can be reviewed and called no ball]). If the delivery was not a fair delivery he shall indicate that the batsman is not out and advise the on-field umpire to signal no ball. See also paragraph 3.10 below.

- d) Additionally, if the third umpire finds the batsman is out by another mode of dismissal (excluding LBW), or not out by any mode of dismissal (excluding LBW), he shall notify the on-field umpire so that the correct decision is made.
- e) If the third umpire decides the batsman is out a red light is displayed; a green light means not-out. Should the third umpire be temporarily unable to respond, a white light (where available) will remain illuminated throughout the period of interruption to signify to the on-field umpires that the TV replay system is temporarily unavailable, in which case the decision will be taken by the on-field umpire. (As an alternative to the red/green light system and where available, the big replay screen may be used for the purpose of conveying the third umpire's decision.)

## 2.2 Caught Decisions

In the event of an appeal for a caught decision:

### a) Fair Catches

- i) Should the bowler's end umpire be unable to decide whether or not a catch was taken fairly, he shall first consult with the square leg umpire.
- ii) Should both on-field umpires require assistance from the third umpire to make a decision, the bowler's end umpire shall firstly take a decision on-field after consulting with the other umpire, then he shall consult by two-way radio with the third umpire. Such consultation shall be initiated by the bowler's end umpire to the third umpire by making the shape of a TV screen with his hands, followed by an 'out' or 'not out' signal made with the hands close to the chest at chest height. Following such consultation, the final decision will be made and given by the bowler's end umpire, who will take into account the on-field umpires' initial views and any other advice received from the third umpire. If the third umpire advises that the replay evidence is inconclusive, the on-field decision communicated at the start of the consultation process shall stand.
- iii) The third umpire has to determine whether the batsman has been caught. However, in reviewing the television replay(s), the third umpire shall first check the fairness of the delivery (all modes of No ball except for the bowler using an illegal action, [for clarity, a specific type of banned delivery can be reviewed and called no ball]) and whether the batsman has hit the ball. If the delivery was not a fair delivery or if it is clear to the third umpire that the batsman did not hit the ball he shall indicate to the on-field umpire that the batsman is not out caught, and in the case of an unfair delivery, advise the on-field umpire to signal no ball. See also paragraph 3.10 below. Additionally, if it is clear to the third umpire that the batsman is out by another mode of dismissal (excluding LBW), or not out by any mode of dismissal (excluding LBW), he shall notify the on-field umpire so that the correct decision is made.

### b) Bump Ball

- i) Should the bowler's end umpire be unable to decide whether a catch was taken from a bump ball or not, he shall first consult with the square leg umpire.
- ii) Should both on-field umpires be unable to make a decision, the bowler's end umpire shall be entitled to refer the decision to the third umpire to review a TV replay(s) of the batsman's stroke as in paragraph 2.1 (b).

- iii) The third umpire has to determine whether the ball was a bump ball or not. However, in reviewing the television replay(s), the third umpire shall first check the fairness of the delivery (all modes of No ball except for the bowler using an illegal action, [for clarity, a specific type of banned delivery can be reviewed and called no ball]) and whether the batsman has hit the ball. If the delivery was not a fair delivery or if it is clear to the third umpire that the batsman did not hit the ball he shall indicate that the batsman is not out and, in the case of an unfair delivery, advise the on-field umpire to signal no ball. See also paragraph 3.10 below. Additionally, if it is clear to the third umpire that the batsman is out by another mode of dismissal (excluding LBW), or not out by any mode of dismissal (excluding LBW), he shall notify the on-field umpire so that the correct decision is made.
- iv) The third umpire shall communicate his decision by the system as in paragraph 2.1 (d).

## 2.3 Boundary Decisions

- a) The on-field umpire shall be entitled to refer to the third umpire for a decision about whether the fieldsman had any part of his person in contact with the ball when he touched the boundary or when he had any part of his person grounded beyond the boundary, or whether a four or six had been scored. A decision is to be made immediately and cannot be changed thereafter.

**Note:** If the television evidence is inconclusive as to whether or not a boundary has been scored, the status quo will remain, and it shall be treated as runs scored by the batting side.

- b) An on-field umpire wishing the assistance of the third umpire in this circumstance shall communicate with the third umpire by use of a two-way radio and the third umpire will convey his decision to the on-field umpire by this method.
- c) The third umpire may initiate contact with the on-field umpire by two-way radio if TV coverage shows a boundary line infringement or incident that appears not to have been acted upon by the on-field umpires.

## 2.4 Obstructing the Field

- a) Following an appeal from the fielding side, the on-field umpire shall be entitled to consult with the third umpire if he feels that the batsman has obstructed the field.
- b) The bowler's end umpire shall firstly take a decision on-field after consulting with the other umpire (if necessary), then he shall consult by two-way radio with the third umpire. Such consultation shall be initiated by the bowler's end umpire to the third umpire by making the shape of a TV screen with his hands, followed by an 'out' or 'not out' signal made with the hands close to the chest at chest height.
- c) Following such consultation with the third umpire, the final decision shall be indicated in the normal fashion by the bowler's end umpire. If the third umpire advises that the replay evidence is inconclusive, the on-field decision communicated at the start of the consultation process shall stand.

## 2.5 Batsmen Running to the Same End

- a) In the event of both batsmen running to the same end and the umpires are uncertain over which batsman made his ground first, the on-field umpire may consult with the third umpire.
- b) The procedure in paragraph 2.3 (b) shall apply.



### 3 PLAYER REVIEW

The following clauses shall operate in addition to and in conjunction with paragraph 2 (Umpire Review).

#### 3.1 Circumstances in which a Player Review may be requested

- a) A player may request a review of any decision taken by the on-field umpires concerning whether or not a batsman is dismissed, with the exception of 'Timed Out' (Player Review).
- b) For the avoidance of doubt, no other decisions made by the umpires are eligible for a Player Review.
- c) Only the batsman involved in a dismissal may request a Player Review of an 'Out' decision and only the captain (or acting captain) of the fielding team may request a Player Review of a 'Not Out' decision.
- d) A decision concerning whether or not a batsman is dismissed that could have been the subject of a Umpire Review under paragraph 2 is eligible for a Player Review as soon as it is clear that the on-field umpire has chosen not to initiate the Umpire Review.

#### 3.2 The manner of requesting the Player Review

- a) The request should be made by the player making a 'T' sign with both forearms at head height.
- b) The total time elapsed between the ball becoming dead and the review request being made should be no more than 15 seconds. The only exception permitted is when an Umpire Review of a fair catch or bump ball (as permitted in Clause 2.2 above) is required to answer an appeal for a Caught decision, in which case either team is able to request a Player Review of that Caught decision within 15 seconds of the decision being communicated. The on-field umpire should provide the player with a prompt after 10 seconds if the request has not been made at that time and the player should request the review immediately thereafter. If the umpires believe that a request has not been made within the 15 second time frame, they will decline to review the decision.
- c) The captain may consult with the bowler and other fielders or the two batsmen may consult with each other prior to deciding whether to request a Player Review. Under no circumstances is any player permitted to query an umpire about any aspect of a decision before deciding on whether or not to request a Player Review. If the umpires believe that the captain or batsman has received direct or indirect input emanating other than from the players on the field, then they may at their discretion decline the request for a Player Review. In particular, signals from the dressing room must not be given.
- d) No replays, either at normal speed or slow motion, should be shown on a big screen to spectators until the time allowed for the requesting of a Player Review has elapsed. The only exception to this provision is when the Player Review of a Caught decision is requested after the Umpire Review of a fair catch or bump ball has concluded, as detailed in 3.2(b) above, as replays may have been shown on the big screen during that Umpire Review process. See also paragraph 3.11 below.

- e) If either on-field umpire initiates an Umpire Review under paragraph 2, this does not preclude a player seeking a Player Review of a separate incident from the same delivery. The Player Review request may be made after the Umpire Review provided it is still within the timescale described in (b) above. (See 3.8 (b) and 3.8 (c) below for the process for addressing both an Umpire and Player Review).
- f) A request for a Player Review may not be withdrawn once it has been made.

### 3.3 The process of consultation

- a) On receipt of an eligible and timely request for a Player Review, the on-field umpire will make the sign of a television with his hands in the normal way.
- b) He will initiate communication with the third umpire by confirming the decision that has been made and that the player has requested a Player Review.
- c) The third umpire must then work alone, independent of outside help or comment, other than when consulting the on-field umpire.
- d) A two-way consultation process should begin to investigate whether there is anything that the third umpire can see or hear which would indicate that the on-field umpire should change his decision.
- e) This consultation should be on points of fact, where possible phrased in a manner leading to yes or no answers. Questions requiring a single answer based on a series of judgements, such as “do you think that was LBW?” are to be avoided.
- f) The third umpire shall not withhold any factual information which may help in the decision making process, even if the information is not directly prompted by the on-field umpire’s questions. In particular, in reviewing a dismissal, if the third umpire believes that the batsman may instead be out by any other mode of dismissal, he shall advise the on-field umpire accordingly. The process of consultation described in this paragraph in respect of such other mode of dismissal shall then be conducted as if the batsman has been given not out.
- g) The third umpire should initially check whether the delivery is fair (all modes of No ball except for the bowler using an illegal action, [for clarity, a specific type of banned delivery can be reviewed and called no ball]) where appropriate advising the on-field umpire accordingly. See also paragraph 3.10 below.
- h) If despite the available technology, the third umpire is unable to answer with a high degree of confidence a particular question posed by the on-field umpire, then he should report that the replays are ‘inconclusive’. The third umpire should not give answers conveying likelihoods or probabilities.
- i) Subject to paragraph 3.3 (j) below, specifically when advising on LBW decisions, the requirement for a high degree of confidence should be interpreted as follows:
  - i) With regard to determining the point of pitching the evidence provided by technology should be regarded as definitive and the Laws as interpreted in clause 3.9 (a) below should be strictly applied.

- ii) With regard to the point of impact
- If a 'not out' decision is being reviewed, in order to report that the point of impact is between wicket and wicket (i.e. in line with the stumps), the evidence provided by technology should show that the centre of the ball at the moment of interception is in line within an area demarcated by a line drawn down the middle of the outer stumps.
  - If an 'out' decision is being reviewed, in order to report that the point of impact is not between wicket and wicket (i.e. outside the line of the stumps), the evidence provided by technology should show that no part of the ball at the moment of interception is between wicket and wicket.

- iii) With regard to determining whether the ball was likely to have hit the stumps:

- If a 'not out' decision is being reviewed, in order to report that the ball is hitting the stumps, the evidence provided by technology should show that the centre of the ball would have hit the stumps within an area demarcated by a line drawn below the lower edge of the bails and down the middle of the outer stumps.

However, where the evidence shows that the ball would have hit the stumps within the demarcated area as set out above but that:

- The point of impact is 300cm or more from the stumps; or
- The point of impact is more than 250cm but less than 300cm from the stumps and the distance between point of pitching and point of impact is less than 40cm,

the original decision will stand (i.e. not out).

- If an 'out' decision is being reviewed, in order to report that the ball is missing the stumps, the evidence of the technology should show that no part of the ball would have made contact with any part of the stumps or bails.

- iv) With regard to determining whether the ball was likely to have hit the stumps after striking the pad on the full and being predicted to pitch before striking or passing the stumps:

- The technology should predict the line of the delivery in accordance with Law 36.2b and show this path from directly above the stumps in the simulation.
- The 3rd umpire shall advise the on-field umpire whether the ball was going to intercept the line of the stumps based on the prediction of the technology, and make no comment on the predicted height of the ball after pitching, which shall remain a judgment of the on-field umpire.

- j) In circumstances where the television technology (all or parts thereof) is not available to the third umpire or fails for whatever reason, the third umpire shall advise the on-field umpire of this fact but still provide any relevant factual information that may be ascertained from the available television replays and other technology. See also paragraph 3.5 (d).

- k) The on-field umpire must then make his decision based on those factual questions that were answered by the third umpire, any other factual information offered by the third umpire and his recollection and opinion of the original incident.
- l) The on-field umpire will reverse his decision if the nature of the supplementary information received from the third umpire leads him to conclude that his original decision was incorrect.

### 3.4 The process for communicating the final decision

- a) When the on-field umpire has reached a decision, he should advise the TV director (directly or via the third umpire).
- b) For Player Reviews concerning potential dismissals, he should then indicate "Out" by raising his finger above his head in a normal yet prominent manner or indicate "Not Out" by the call of 'not out' and by crossing his hands in a horizontal position side to side in front and above his waist three times (as per a 'safe' decision in baseball). Where the decision is a reversal of the on-field umpire's previous decision, he should make the 'revoke last signal' indication immediately prior to the above.
- c) If the mode of dismissal is not obvious or not the same as that on which the original decision was based, then the umpire should advise the official scorers via the third umpire.

### 3.5 Number of Player Review requests permitted

Subject to the provisions of clauses a) to g) below, each team will have two unsuccessful player review requests remaining immediately after the completion of the 80th over of the innings. For the sake of clarity, at the end of the 80th over a team with no remaining player reviews receives 2 additional reviews; a team with 1 remaining player review receives 1 additional review, and a team with 2 remaining player reviews receives no additional reviews.

- a) Subject to the above, each team is allowed to make a maximum of two unsuccessful player review requests in the first 80 overs of the innings, and a maximum of two unsuccessful player review requests after 80 overs for the remainder of the innings. If a player review results in the umpire reversing his original decision, then the request has been successful and does not count towards the innings limit. If the umpire's decision is unchanged, the player review is unsuccessful. After two unsuccessful requests by one team within the first 80 overs, no further player review requests will be allowed by that team until after 80 overs. After two unsuccessful requests by one team, both made after the first 80 overs, no further player review requests will be allowed by that team during the remainder of that innings.
- b) If following a Player Review, an umpire upholds a decision of 'Out', but for a different mode of dismissal from that for which the original decision was given, then the request will still be regarded as unsuccessful.
- c) If following a Player Review, an umpire upholds a decision of 'Not Out' on account of the delivery being a no ball for any reason, thereby not requiring any review of the ball's subsequent trajectory, then this will not be counted as an unsuccessful request and not count towards the innings limit.

- d) If a Player Review and an Umpire Review occur from the same delivery and the decision from the Umpire Review renders the Player Review unnecessary (see 3.8 (b) and 3.8 (c)), then the Player Review request will be ignored and not be counted as unsuccessful.
- e) An unsuccessful review may be re-instated by the Match Referee at his sole discretion (if appropriate after consultation with the ICC Technical Official and/or the television broadcast director), if the review could not properly be concluded due to a failure of the technology. Any such decision shall be final and should be taken as soon as possible once all the relevant facts have been ascertained by the Match Referee. An unsuccessful review shall not be re-instated if, despite any technical failures, the correct decision could still have been made using the other available technology. Similarly, no reinstatement shall be made where the technology worked as intended, but the evidence gleaned from its use was “inconclusive”.
- f) The third umpire shall be responsible for counting the number of unsuccessful player reviews and advising the on-field umpires once either team has exhausted their allowance either for the first 80 overs or for the innings.
- g) The scoreboard shall display, for the innings in progress, the number of Player Reviews remaining available to each team.

### 3.6 Dead ball

- a) If following a Player Review request, an original decision of ‘Out’ is changed to ‘Not Out’, then the ball is still deemed to have become dead when the original decision was made (as per Law 23.1(a)(iii)). The batting side, while benefiting from the reversal of the dismissal, will not benefit from any runs that may subsequently have accrued from the delivery had the on-field umpire originally made a ‘Not Out’ decision, other than any No Balls penalty that could arise under 3.3 (g) above.
- b) If an original decision of ‘Not Out’ is changed to ‘Out’, the ball will retrospectively be deemed to have become dead from the moment of the dismissal event. All subsequent events, including any runs scored, are ignored.

### 3.7 Use of technology

- a) The following technology may be used by the third umpire.
  - Slow motion replays from all available cameras
  - Super slow motion replays from all available cameras
  - Ultra motion camera replays from all available cameras
  - Sound from the stump microphones with the replays at normal speed and slow motion
  - Approved ball tracking technology
  - The mat, generated by the provider of ball tracking technology, not by the broadcaster
  - Hot Spot cameras
  - Real-Time Snickometer

In addition, other forms of technology may be used subject to ICC being satisfied that the required standards of accuracy and time efficiency can be met.

- b) Where practical usage or further testing indicates that any of the above forms of technology cannot reliably provide accurate and timely information, then it may be removed prior to or during a match. The final decision regarding the technology to be used in a given match will be taken by the ICC Match Referee in consultation with the ICC Technical Official, ICC Management and the competing teams' governing bodies.

### 3.8 Combining Umpire Reviews with Player Reviews

- a) If an Umpire Review (under Clause 2) and a Player Review request are made following the same delivery but relating to separate modes of dismissal, the following procedure shall apply.
- b) The Umpire Review should be carried out prior to the Player Review if **all** of the following conditions apply:
  - i) The Player Review has been requested by the fielding side
  - ii) The Umpire Review and the Player Review both relate to the dismissal of the same batsman
  - iii) If the batsman is out, the number of runs scored from the delivery would be the same for both modes of dismissal
  - iv) If the batsman is out, the batsman on strike for the next delivery would be the same for both modes of dismissal.
- c) If the Umpire Review leads the third umpire to make a decision of 'Out', then this will be displayed in the usual manner and the Player Review will not be performed. If the Umpire Review results in a not out decision, then the third umpire will make no public decision but proceed to address the Player Review request.

*For illustration, following an unsuccessful lbw appeal, the striker sets off for a run, is sent back and there is an appeal for his run out. The players request that the lbw decision is reviewed and the umpires request that the run out be reviewed. The four criteria above are satisfied, so the run out referral is determined first. Should the appeal for run out be 'Out', then there is no requirement for the lbw review to take place.*

- d) In all other circumstances, the two incidents shall be addressed in chronological order. If the conclusion from the first incident is that a batsman is dismissed, then the ball would be deemed to have become dead at that point, rendering investigation of the second incident unnecessary.

### 3.9 Interpretation of Laws

- a) When using technology to determine where the ball pitched (as per Law 36.1(b)), the third umpire should refer to the "point" (or centre) of the ball. Therefore if at least 50% of the ball pitches outside the line of leg stump, then no LBW dismissal is possible.
- b) When using a replay to determine the moment at which the wicket has been put down (as per Law 28.1), the third umpire should deem this to be the first frame in which one of the bails is shown (or can be deduced) to have lost **all** contact with the top of the stumps and subsequent frames show the bail permanently removed from the top of the stumps.

**3.10 No Balls**

Following any mode of dismissal that is not permitted off a no ball and which is not the subject of an Umpire or Player Review, if the on-field umpire is uncertain as the fairness of the delivery he shall be entitled to request the batsman to delay leaving the field and to check the fairness of the delivery (all modes of No ball except for the bowler using an illegal action, [for clarity, a specific type of banned delivery can be reviewed and called no ball]) with the third umpire. Consultation with the third umpire shall be by way of two way radio. If the delivery was not a fair delivery the on-field umpire shall indicate that the batsman is not-out and signal no-ball. For the avoidance of doubt, the third umpire shall apply clause 24.2 when deciding whether a no-ball should have been called.

**3.11 Cameras On or Over the Field of Play**

The on-field umpire shall be entitled to refer to the third umpire for a decision as to whether the ball has been in contact with any part of the camera, its apparatus or its cables above the playing area.

A decision is to be made immediately and cannot be changed thereafter.

An on-field umpire wishing the assistance of the third umpire in this circumstance shall communicate with the third umpire by use of a two-way radio and the third umpire will convey his decision to the on-field umpire by this method.

The third umpire may initiate contact with the on-field umpire by two-way radio if TV coverage shows the ball to have been in contact with any part of the camera or its cables above the playing area as envisaged under this paragraph.

Refer to clause 23.1.

**3.12 Big Screen Policy**

The current ICC big screen policy will apply.

See also 3.2(d)

## **APPENDIX 2**

### **DRS Third Umpire Room and Television Broadcast Specifications**

Specifications will be circulated separately.



## APPENDIX 3

### Third Umpire TV Replay System – Playing Conditions

#### 1 GENERAL

- 1.1 Save with the express written consent of the Chief Executive Officer of the ICC the Home Board will ensure the live television broadcast of all Test Matches played in its country.
- 1.2 Where matches are broadcast the camera specification set out in Appendix 4A shall be mandatory as a minimum requirement.
- 1.3 Where matches are not broadcast the camera specifications set out in Appendix 4B shall be mandatory as a minimum requirement.
- 1.4 The Home Board will ensure a separate room is provided for the third umpire and that he has access to television monitors and direct sound link with the television control broadcast director to facilitate as many replays as is necessary to assist him in making a decision.
- 1.5 In the circumstances detailed in paragraphs 2, 3, 4, 5 and 6 below, the on-field umpire has the discretion to refer the decision to the third umpire or, in the case of paragraph 3.1, 5 and 6, to consult with the third umpire before making his decision and should take a common sense approach.  
  
Players may not appeal to the umpire to use the replay system - breach of this provision would constitute dissent and the player could be liable for discipline under the ICC Code of Conduct.
- 1.6 The third umpire shall call for as many replays from any camera angle as is necessary to reach a decision. As a guide, a decision should be made within 30 seconds whenever possible, but the third umpire shall have a discretion to take more time in order to finalise a decision.
- 1.7 The third umpire shall only have access to TV replays for the provisions of paragraphs 2, 3, 4, 5 and 6 below. Other technology which may be in use by the broadcaster for broadcast purposes (Hot Spot, ball tracking, Snicko) shall not be permitted.

#### 2 RUN OUT, STUMPING AND HIT WICKET DECISIONS

- 2.1 The on-field umpire shall be entitled to refer an appeal for a run-out, stumping or hit wicket to the third umpire.
- 2.2 An on-field umpire wishing to refer a decision to the third umpire shall signal to the third umpire by making the shape of a TV screen with his hands.
- 2.3 If the third umpire decides the batsman is out a red light is displayed; a green light means not-out. Should the third umpire be temporarily unable to respond, a white light (where available) will remain illuminated throughout the period of interruption to signify to the on-field umpires that the TV replay system is temporarily unavailable, in which case the decision will be taken by the on-field umpire. (As an alternative to the red/green light system and where available, the big screen may be used for the purpose of conveying the third umpire's decision.)
- 2.4 In the case of a referral of a hit wicket or stumping decision, the third umpire shall first check the fairness of the delivery (all modes of No ball except for the bowler using an illegal action, [for clarity, a specific type of banned delivery can be reviewed and called no ball]). Additionally, if the third umpire finds the batsman is out by another mode of dismissal (excluding LBW), or not out by any mode of dismissal (excluding LBW), he shall notify the on-field umpire so that the correct decision is made.

## 3 CAUGHT DECISIONS

The on-field umpire shall be entitled to refer an appeal for a caught decision to the third umpire in the following circumstances:

### 3.1 Fair Catches

- a) Should the bowler's end umpire be unable to decide whether or not a catch was taken fairly, he shall first consult with the square leg umpire.
- b) Should both on-field umpires require assistance from the third umpire to make a decision, the bowler's end umpire shall firstly take a decision on-field after consulting with the other umpire, then he shall consult by two-way radio with the third umpire. Such consultation shall be initiated by the bowler's end umpire to the third umpire by making the shape of a TV screen with his hands, followed by an 'out' or 'not out' signal made with the hands close to the chest at chest height. Following such consultation, the final decision will be made and given by the bowler's end umpire, who will take into account the on-field umpires' initial views and any other advice received from the third umpire. If the third umpire advises that the replay evidence is inconclusive, the on-field decision communicated at the start of the consultation process shall stand.
- c) The third umpire has to determine whether the batsman has been caught. However, when reviewing the television replay(s), the third umpire shall first check the fairness of the delivery (all modes of No ball except for the bowler using an illegal action, [for clarity, a specific type of banned delivery can be reviewed and called no ball]). Additionally, if it is clear to the third umpire that the batsman is out by another mode of dismissal (excluding LBW), or not out by any mode of dismissal (excluding LBW), he shall notify the on-field umpire so that the correct decision is made.
- d) The final decision shall be indicated in the normal fashion by the bowler's end umpire.

### 3.2 Bump Ball

- a) Should the bowler's end umpire be unable to decide whether a catch was taken from a bump ball or not, he shall first consult with the square leg umpire.
- b) Should both on-field umpires be unable to make a decision, the bowler's end umpire shall be entitled to refer the decision to the third umpire to review a TV replay(s) of the batsman's stroke as in paragraph 2.2.
- c) The third umpire has to determine whether the ball was a bump ball or not. However, in reviewing the television replay(s), the third umpire shall first check the fairness of the delivery (all modes of No ball except for the bowler using an illegal action, [for clarity, a specific type of banned delivery can be reviewed and called no ball]) and whether the batsman has hit the ball. If the delivery was not a fair delivery or if it is clear to the third umpire that the batsman did not hit the ball he shall indicate that the batsman is not out and, in the case of an unfair delivery, advise the on-field umpire to signal no ball. See also clause 7 below. Additionally, if it is clear to the third umpire that the batsman is out by another mode of dismissal (excluding LBW), or not out by any mode of dismissal (excluding LBW), he shall notify the on-field umpire so that the correct decision is made.
- d) The third umpire shall communicate his decision by the system as in paragraph 2.3.

#### 4 BOUNDARY DECISIONS

- 4.1 The on-field umpire shall be entitled to refer to the third umpire for a decision about whether the fieldsman had any part of his person in contact with the ball when he touched the boundary or when he had any part of his person grounded beyond the boundary, or whether a four or six had been scored. A decision is to be made immediately and cannot be changed thereafter.
- 4.2 An on-field umpire wishing the assistance of the third umpire in this circumstance shall communicate with the third umpire by use of a two-way radio and the third umpire will convey his decision to the on-field umpire by this method.
- 4.3 The third umpire may initiate contact with the on-field umpire by two-way radio if TV coverage shows a boundary line infringement or incident that appears not to have been acted upon by the on-field umpires.

#### 5 OBSTRUCTING THE FIELD

- a) Following an appeal from the fielding side, the on-field umpire shall be entitled to consult with the third umpire if he feels that the batsman has obstructed the field.
- b) The bowler's end umpire shall firstly take a decision on-field after consulting with the other umpire (if necessary), then he shall consult by two-way radio with the third umpire. Such consultation shall be initiated by the bowlers end umpire to the third umpire by making the shape of a TV screen with his hands, followed by an 'out' or 'not out' signal made with the hands close to the chest at chest height.
- c) Following such consultation with the third umpire, the final decision shall be indicated in the normal fashion by the bowlers end umpire. If the third umpire advises that the replay evidence is inconclusive, the on-field decision communicated at the start of the consultation process shall stand.

#### 6 BATSMEN RUNNING TO THE SAME END

- 6.1 In the event of both batsmen running to the same end and the umpires are uncertain over which batsman made his ground first, the on-field umpire may consult with the third umpire.
- 6.2 The procedure in paragraph 4.2 shall apply.

#### 7 NO BALLS

Following any mode of dismissal that is not permitted off a no ball, if the on-field umpire is uncertain as the fairness of the delivery, he shall be entitled to request the batsman to delay leaving the field and to check the fairness of the delivery (all modes of No ball except for the bowler using an illegal action, [for clarity, a specific type of banned delivery can be reviewed and called no ball]) with the third umpire. Consultation with the third umpire shall be by way of two way radio. If the delivery was not a fair delivery the on-field umpire shall indicate that the batsman is not-out and signal no-ball. For the avoidance of doubt, the third umpire shall apply clause 24.2 when deciding whether a no-ball should have been called.

## 8 CAMERAS ON OR OVER THE FIELD OF PLAY

The on-field umpire shall be entitled to refer to the third umpire for a decision as to whether the ball has been in contact with any part of the camera, its apparatus or its cables above the playing area.

A decision is to be made immediately and cannot be changed thereafter.

An on-field umpire wishing the assistance of the third umpire in this circumstance shall communicate with the third umpire by use of a two-way radio and the third umpire will convey his decision to the on-field umpire by this method.

The third umpire may initiate contact with the on-field umpire by two-way radio if TV coverage shows the ball to have been in contact with any part of the camera or its cables above the playing area as envisaged under this paragraph.

Refer to clause 23.1.

### APPENDIX 4A

#### Generic Camera Layout - Basic TV Coverage

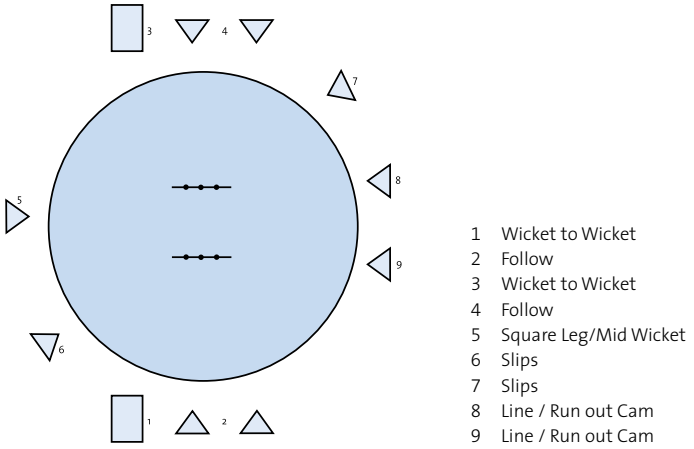

### APPENDIX 4B

#### Generic Camera Layout - Third Umpire Coverage

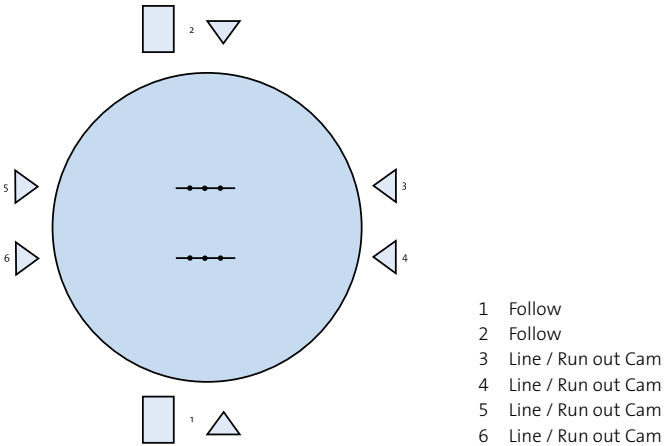

## APPENDIX 5

### Calculation Template for Last Day of Test Match

This template applies to any interruption on the last day which causes a loss in actual playing time, (i.e. an interruption longer than the amount of extra time available) and where play resumes after the scheduled tea interval.

Where play resumes prior to tea, then the calculation of overs remaining in the day is performed as per Days 1-4, with the scheduled time for the last hour affected only by the adding of any extra time.

Lines A, B, C, D and E should be completed at the start of an interruption on the final day. If play resumes without any lost playing time, or prior to the tea interval, then this sheet can be discarded.

Once the length of interruption exceeds D and actual playing time is lost, then line F can be completed

Lines G and H can be completed immediately if the interruption starts after tea, otherwise as soon as the interruption includes the tea interval.

- A Start of interruption \_\_\_\_\_
- B Minimum overs remaining before start of last hour as at time A  
(See Note 1) \_\_\_\_\_
- C Time required to bowl minimum overs @ 4 mins per over (B x 4) \_\_\_\_\_
- D Extra time available as at time A \_\_\_\_\_
- E Scheduled time for last hour as at time A \_\_\_\_\_
- F Rescheduled time for last hour (Time basis) (D + E) \_\_\_\_\_
- G Length of intervals covered by interruption:  
enter 40 (lunch), 20 (tea), 60 (both) or 0 (neither) \_\_\_\_\_
- H Rescheduled time for last hour (Overs basis) (A + C + D + G) \_\_\_\_\_
- I Later of F and H above \_\_\_\_\_
- J Time play resumes \_\_\_\_\_

**Case A:** If J is earlier than I, play resumes prior to the last hour

**K** Minutes playing time lost ( $J - A - D - G$ ) \_\_\_\_\_

**L** Overs lost @ 4 mins per over (see Note 2)

**M** Minimum overs before start of last hour ( $B - L$ ) (See Note 1)  
The last hour then starts at the later of the time in Line F  
and the completion of the overs in Line M \_\_\_\_\_

**Case B:** If J is not earlier than I, play resumes in the last hour

**K** Time for last hour to finish (I plus 60 minutes) \_\_\_\_\_

**L** Minutes remaining in last hour ( $K - J$ ) \_\_\_\_\_

**M** Overs remaining in last hour ( $L / 4$  mins or part thereof)  
(See Note 1) \_\_\_\_\_

**Note 1:** If an interruption occurs part-way through an over, in Row B enter the number of full overs remaining, ignoring the part over. Then in Row M, add back the part over to the minimum overs to be bowled on resumption.

**Note 2:** The actual overs lost for a given interruption will also reflect any earlier interruptions in the day, so that one over is lost in the day for each full four minutes of aggregated playing time lost. For example, 15 minutes loses 3 overs, but another 15 minute delay loses 4 overs.

